



**NIST NCSTAR 1**

Federal Building and Fire Safety Investigation  
of the World Trade Center Disaster

# **Final Report** on the **Collapse of** **the World Trade Center Towers**

**NIST**

**National Institute of  
Standards and Technology**

Technology Administration  
U.S. Department of Commerce



**NIST NCSTAR 1**

Federal Building and Fire Safety Investigation  
of the World Trade Center Disaster

# **Final Report** on the **Collapse of the World Trade Center Towers**

September 2005



U.S. Department of Commerce  
*Carlos M. Gutierrez, Secretary*

Technology Administration  
*Michelle O'Neill, Acting Under Secretary for Technology*

National Institute of Standards and Technology  
*William Jeffrey, Director*

#### Disclaimer No. 1

Certain commercial entities, equipment, products, or materials are identified in this document in order to describe a procedure or concept adequately or to trace the history of the procedures and practices used. Such identification is not intended to imply recommendation, endorsement, or implication that the entities, products, materials, or equipment are necessarily the best available for the purpose. Nor does such identification imply a finding of fault or negligence by the National Institute of Standards and Technology.

#### Disclaimer No. 2

The policy of NIST is to use the International System of Units (metric units) in all publications. In this document, however, units are presented in metric units or the inch-pound system, whichever is prevalent in the discipline.

#### Disclaimer No. 3

Pursuant to section 7 of the National Construction Safety Team Act, the NIST Director has determined that certain evidence received by NIST in the course of this Investigation is "voluntarily provided safety-related information" that is "not directly related to the building failure being investigated" and that "disclosure of that information would inhibit the voluntary provision of that type of information" (15 USC 7306c).

In addition, a substantial portion of the evidence collected by NIST in the course of the Investigation has been provided to NIST under nondisclosure agreements.

#### Disclaimer No. 4

NIST takes no position as to whether the design or construction of a WTC building was compliant with any code since, due to the destruction of the WTC buildings, NIST could not verify the actual (or as-built) construction, the properties and condition of the materials used, or changes to the original construction made over the life of the buildings. In addition, NIST could not verify the interpretations of codes used by applicable authorities in determining compliance when implementing building codes. Where an Investigation report states whether a system was designed or installed as required by a code *provision*, NIST has documentary or anecdotal evidence indicating whether the requirement was met, or NIST has independently conducted tests or analyses indicating whether the requirement was met.

#### Use in Legal Proceedings

No part of any report resulting from a NIST investigation into a structural failure or from an investigation under the National Construction Safety Team Act may be used in any suit or action for damages arising out of any matter mentioned in such report (15 USC 281a; as amended by P.L. 107-231).

**National Institute of Standards and Technology National Construction Safety Team Act Report 1  
Natl. Inst. Stand. Technol. Natl. Constr. Sfty. Tm. Act Rpt. 1, 298 pages (September 2005)  
CODEN: NSPUE2**

U.S. GOVERNMENT PRINTING OFFICE  
WASHINGTON: 2005

---

For sale by the Superintendent of Documents, U.S. Government Printing Office  
Internet: bookstore.gpo.gov — Phone: (202) 512-1800 — Fax: (202) 512-2250  
Mail: Stop SSOP, Washington, DC 20402-0001

# NATIONAL CONSTRUCTION SAFETY TEAM FOR THE FEDERAL BUILDING AND FIRE SAFETY INVESTIGATION OF THE WORLD TRADE CENTER DISASTER

---

S. Shyam Sunder, Sc.D. (NIST)	Lead Investigator
Richard G. Gann, Ph.D. (NIST)	Final Report Editor; Project Leader, Project 5: Reconstruction of Thermal and Tenability Environment
William L. Grosshandler, Ph.D. (NIST)	Associate Lead Investigator; Project Leader, Project 4: Investigation of Active Fire Protection Systems
H.S. Lew, Ph.D., P.E. (NIST)	Co-Project Leader, Project 1: Analysis of Building and Fire Codes and Practices
Richard W. Bukowski, P.E. (NIST)	Co-Project Leader, Project 1: Analysis of Building and Fire Codes and Practices
Fahim Sadek, Ph.D. (NIST)	Project Leader, Project 2: Baseline Structural Performance and Aircraft Impact Damage Analysis
Frank W. Gayle, Ph.D. (NIST)	Project Leader, Project 3: Mechanical and Metallurgical Analysis of Structural Steel
John L. Gross, Ph.D., P.E. (NIST)	Co-Project Leader, Project 6: Structural Fire Response and Collapse Analysis
Therese P. McAllister, Ph.D., P.E. (NIST)	Co-Project Leader, Project 6: Structural Fire Response and Collapse Analysis
Jason D. Averill (NIST)	Project Leader, Project 7: Occupant Behavior, Egress, and Emergency Communications
J. Randall Lawson (NIST)	Project Leader, Project 8: Fire Service Technologies and Guidelines
Harold E. Nelson, P.E.	Fire Protection Engineering Expert
Stephen A. Cauffman (NIST)	Program Manager

This page intentionally left blank.

## CONTRIBUTORS TO THE INVESTIGATION

---

---

### NIST TECHNICAL STAFF

---

Mohsen Altafi	Jeffrey Fong	Max Peltz
Robert Anleitner	Glenn Forney	Lisa Petersen
Elisa Baker	William Fritz	Rochelle Plummer
Stephen Banovic	Anthony Hamins	Kuldeep Prasad
Howard Baum	Edward Hnetkovsky	Natalia Ramirez
Carlos Beauchamp	Erik Johnsson	Ronald Rehm
Dale Bentz	Dave Kelley	Paul Reneke
Charles Bouldin	Mark Kile	Michael Riley
Paul Brand	Erica Kuligowski	Lonn Rodine
Lori Brassell	Jack Lee	Schuyler Ruitberg
Kathy Butler	William Luecke	Jose Sanchez
Nicholas Carino	Alexander Maranghides	Raymond Santoyo
Sandy Clagett	David McColskey	Steven Sekellick
Ishmael Conteh	Chris McCowan	Michael Selepak
Matthew Covin	Jay McElroy	Thomas Siewert
Frank Davis	Kevin McGrattan	Emil Simiu
David Dayan	Roy McLane	Monica Starnes
Laurean DeLauter	George Mulholland	David Stroup
Jonathan Demarest	Lakeshia Murray	Laura Sugden
Stuart Dols	Kathy Notarianni	Robert Vettori
Michelle Donnelly	Joshua Novosel	John Widmann
Dat Duthinh	Long Phan	Brendan Williams
David Evans	William Pitts	Maureen Williams
Richard Fields	Thomas Ohlemiller	Jiann Yang
James Filliben	Victor Ontiveros	Robert Zarr
Tim Foecke	Richard Peacock	

### NIST EXPERTS AND CONSULTANTS

---

Vincent Dunn  
Steven Hill  
John Hodgens  
Kevin Malley  
Valentine Junker

**DEPARTMENT OF COMMERCE AND NIST INSTITUTIONAL SUPPORT**

---

Michele Abadia-Dalmau	James Hill	Karen Perry
Kellie Beall	Verna Hines	Sharon Rinehart
Arden Bement, Jr.	Kathleen Kilmer	Michael Rubin
Audra Bingaman	Kevin Kimball	Rosamond Rutledge-Burns
Sharon Bisco	Thomas Klausing	John Sanderson
Phyllis Boyd	Donna Kline	Hratch Semerjian
Marie Bravo	Fred Kopatich	Sharon Shaffer
Craig Burkhardt	Kenneth Lechter	Elizabeth Simon
Paul Cataldo	Melissa Lieberman	Jack Snell
Virginia Covahey	Darren Lowe	Michael Szwed
Deborah Cramer	Mark Madsen	Kelly Talbott
Gail Crum	Ronald Meininger	Anita Tolliver
Jane Dana	Romena Moy	Joyce Waters
Sherri Diaz	Michael Newman	Teresa Vicente
Sandra Febach	Gail Porter	Dawn Williams
Susan Ford	Thomas O'Brian	
James Fowler	Nualla O'Connor-Kelly	
Matthew Heyman	Norman Osinski	

**NIST CONTRACTORS**

---

**Applied Research Associates, Inc.**

Steven Kirkpatrick*	Marsh Hardy	Claudia Navarro
Robert T. Bocchieri	Samuel Holmes	Brian D. Peterson
Robert W. Cilke	Robert A. MacNeill	Justin Y-T. Wu

**Baseline, Inc.**

Martin Klain

**Computer Aided Engineering Associates, Inc.**

Peter Barrett*	Daniel Fridline
Michael Bak	James J. Kosloski

**DataSource, Inc.**

John Wivaag

**GeoStats, Inc.**

Marcello Oliveira



**Gilsanz Murray Steficek LLP**

Ramon Gilsanz

**Hughes Associates, Inc.**

Ed Budnick\*

Mike Ferreira\*

Mark Hopkins

Matt Hulcher

Alwin Kelly

Chris Mealy

John Schoenrock

Steven Strega

Karen Dawn Tooren

**Independent Contractors**

Ajmal Abbasi

Eduardo Kausel

David Parks

David Sharp

Daniele Veneziano

Josef Van Dyck

Kaspar Willam

**Isolatek International, Inc.**

Paulette Kaminski

**John Jay College**

Norman Groner

**Leslie E. Robertson Associates, R.L.L.P.**

William J. Faschan\*

Richard B. Garlock\*

William C. Howell

Raymond C. Lai

**National Fire Protection Association**

Rita Fahey\*

Norma Candeloro

Joseph Molis

**National Research Council, Canada**

Gyulene Proulx\*

Amber Walker

**NuStats, Inc.**

Johanna Zmud\*

Carlos Arce

Heather Contrino

Christopher Frye

Nancy McGuckin

Sandra Rodriguez

Della Santos

Robert Santos

**Rolf Jensen & Associates, Inc.**

Ray Grill*	Tom Brown	Bob Keough
Ed Armm	Duane Johnson	Joseph Razz

**Rosenwasser/Grossman Consulting Engineers, P.C.**

Jacob Grossman\*  
Craig Leech  
Arthur Seigel

**Science Applications International Corporation**

John Eichner*	Pamela Curry	Mark Madara
Cheri Sawyer*	John DiMarzio	Walter Soverow
Lori Ackman	Heather Duvall	Paul Updike
Marina Bogatine	Mark Huffman	Yvonne Zagadou
Sydel Cavanaugh	Charlotte Johnson	
Kathleen Clark	Michael Kalmar	

**Simpson Gumpertz & Heger Inc.**

Mehdi Zarghamee*	Ron Hamburger	Wassim I. Naguib
Glenn Bell	Frank Kan	Rasko P. Ojdrovic
Said Bolourchi	Yasuo Kitane	Andrew T. Sarawit
Daniel W. Eggers	Atis Liepins	Pedro Sifre
Ömer O. Erbay	Michael Mudlock	

**S. K. Ghosh Associates, Inc.**

S. K. Ghosh*	Dave Fanella
Analdo Derecho	Xumei Liang

**Skidmore, Owings & Merrill, LLP**

Bill Baker  
Bob Sinn  
John Zils

**Teng & Associates, Inc.**

Shankar Nair

**Underwriters Laboratories, Inc.**

Fred Hervey*	Mark Izydorek	William Joy
Joseph Treadway*	Aldo Jimenez	John Mammoser

**University at Buffalo, The State University of New York**

Andrew Whitaker\*  
Andrei Reinhorn  
Joshua Repp

**University of Chicago Survey  
Lab**

Virginia Bartot  
Martha van Haitsma

**University of Colorado**

Dennis Mileti

**University of Michigan**

Jamie Abelson

**Wiss, Janney, Elstner Associates, Inc.**

Ray Tide\*  
Jim Hauck  
Conrad Paulson

**COOPERATING ORGANIZATIONS**

---

**American Airlines**

Desmond Barry  
Morgan Heyer

**The Boeing Company**

Marlene Nelson

**Blanford Land Development  
Corporation**

Lisa Lickman  
Ron Lickman  
John Sandy

**Carr Futures, Inc.**

David Mangold

**City of New York Fire  
Department**

Alexandra Fisher  
Allen S. Hay

**Federal Bureau of  
Investigation**

Kenneth Marr

**Hugo Neu Schnitzer East**

Robert Kelman  
Steve Shinn  
Frank Manzo

**Laclede Steel**

David McGee

**Marsh & McLennan  
Companies**

Thomas Gress  
Michael Lyons

**Metal Management Northeast, Inc.**

Michael Henderson  
Alan Ratner  
John Silva

**National Commission on Terrorist Attacks Upon the United States**

Madeline Blot  
Sam M. W. Casperson

George L. Delgrosso  
Daniel Marcus

James Miller  
Catherine S. Taylor

**New York City Law Department**

Lawrence S. Kahn

Jay L. Cohen

Gary Shaffer

Rachel Relkin

Joanna Weiss

George C. D. Duke

Katherine Winningham

Jessie Levine

**New York City Police Department**

Michael F. Healey

**The Port Authority of New York and New Jersey**

James Begley

Saroj Bhol

Gerry Gaeta

Jeffrey Gertier

Frank Lombardi

Alan Reiss

Nancy Seliga

**Siemens**

Steven Shamash

John Farrington

Robert Salamone

**Silverstein Properties**

**Simpson, Thacher & Bartlett  
LLP**

Jamie Gamble

**Structural Engineers  
Association of New York**

Ed DiPaolo

**Wachtell, Lipton, Rosen &  
Katz**

Marc Wolinsky

Andrew Cheung

**United Air Lines**

John Midgett

Norvis Huevo

**Williams & Connolly LLP**

Philip Sechler

---

\*Principal Investigator/Key Contact

## DEDICATION

---

On the morning of September 11, 2001, Americans and people around the world were shocked by the destruction of the World Trade Center (WTC) in New York City and the devastation of the Pentagon near Washington, D.C., after large aircraft were flown into the buildings, and the crash of an aircraft in a Pennsylvania field that averted further tragedy. Four years later, the world has been changed irrevocably by those terrorist attacks. For some, the absence of people close to them is a constant reminder of the unpredictability of life and death. For millions of others, the continuing threats of further terrorist attacks affect how we go about our daily lives and the attention we must give to homeland security and emergency preparedness.

Within the construction, building, and public safety communities, there arose a question pressing to be answered: How can we reduce our vulnerability to such attacks, and how can we increase our preparedness and safety while still ensuring the functionality of the places in which we work and live?

This Investigation has, to the best extent possible, reconstructed the response of the WTC towers and the people on site to the consequence of the aircraft impacts. It provides improved understanding to the professional communities and building occupants whose action is needed and to those most deeply affected by the events of that morning. In this spirit, this report is dedicated to those lost in the disaster, to those who have borne the burden to date, and to those who will carry it forward to improve the safety of buildings.

This page intentionally left blank.

# ABSTRACT

---

This is the final report on the National Institute of Standards and Technology (NIST) investigation of the collapse of the World Trade Center (WTC) towers, conducted under the National Construction Safety Team Act. This report describes how the aircraft impacts and subsequent fires led to the collapse of the towers after terrorists flew jet fuel laden commercial airliners into the buildings; whether the fatalities were low or high, including an evaluation of the building evacuation and emergency response procedures; what procedures and practices were used in the design, construction, operation, and maintenance of the towers; and areas in current building and fire codes, standards, and practices that warrant revision. Extensive details are found in the 42 companion reports. The final report on the collapse of WTC 7 will appear in a separate report.

Also in this report is a description of how NIST reached its conclusions. NIST complemented in-house expertise with private sector technical experts; accumulated copious documents, photographs, and videos of the disaster; established baseline performance of the WTC towers; performed computer simulations of the behavior of each tower on September 11, 2001; combined the knowledge gained into a probable collapse sequence for each tower; conducted nearly 1,200 first-person interviews of building occupants and emergency responders; and analyzed the evacuation and emergency response operations in the two high-rise buildings.

The report concludes with a list of 30 recommendations for action in the areas of increased structural integrity, enhanced fire endurance of structures, new methods for fire resistant design of structures, enhanced active fire protection, improved building evacuation, improved emergency response, improved procedures and practices, and education and training.

Keywords: Aircraft impact, building evacuation, emergency response, fire safety, human behavior, structural collapse, tall buildings, wind engineering, World Trade Center.

This page intentionally left blank.



# TABLE OF CONTENTS

---

National Construction Safety Team for the Federal Building and Fire Safety Investigation of the World Trade Center Disaster .....	iii
Contributors to the Investigation.....	v
Dedication .....	xi
Abstract .....	xiii
List of Figures .....	xxi
List of Tables .....	xxv
List of Acronyms and Abbreviations .....	xxvii
Preface .....	xxix
Executive Summary .....	xxxv
<b>Part I: September 11, 2001 .....</b>	<b>1</b>
Chapter 1	
<b>New York City's World Trade Center .....</b>	<b>1</b>
1.1 The Origination.....	1
1.2 The World Trade Center Complex .....	2
1.2.1 The Site.....	2
1.2.2 The Towers.....	5
Chapter 2	
<b>The Account of World Trade Center 1 .....</b>	<b>19</b>
2.1 8:46:30 a.m. EDT.....	19
2.2 The Aircraft.....	20
2.3 The Immediate Damage.....	20
2.4 The Jet Fuel.....	24
2.5 8:47 a.m. to 9:02 a.m. EDT.....	24
2.6 9:02:59 a.m. EDT.....	27
2.7 9:03 a.m. to 9:57 a.m. EDT.....	27
2.8 9:58:59 a.m. EDT.....	32
2.9 9:59 a.m. to 10:28 a.m. EDT.....	32
2.10 The Outcome.....	34

Chapter 3	
<b>The Account of World Trade Center 2 .....</b>	<b>37</b>
3.1 8:46:30 a.m. EDT.....	37
3.2 9:02:59 a.m. EDT.....	38
3.3 The Immediate Damage.....	38
3.4 The Jet Fuel.....	42
3.5 9:03 a.m. to 9:36 a.m. EDT.....	42
3.6 9:36 a.m. to 9:58 a.m. EDT.....	44
3.7 The Outcome.....	45
 Chapter 4	
<b>The Toll .....</b>	<b>47</b>
 <b>Part II: Reconstructing the Disaster .....</b>	<b>49</b>
 Chapter 5	
<b>The Design and Construction of the Towers .....</b>	<b>51</b>
5.1 Building and Fire Codes .....	51
5.2 The Codes and the Towers.....	52
5.2.1 The New York City Building Code.....	52
5.2.2 Pertinent Construction Provisions .....	53
5.2.3 Tenant Alteration Process.....	54
5.3 Building Design .....	55
5.3.1 Loads .....	55
5.3.2 Aircraft Impact .....	55
5.3.3 Construction Classification and Fire Resistance Rating.....	55
5.3.4 Compartmentation .....	56
5.3.5 Egress Provisions .....	57
5.3.6 Active Fire Protection .....	61
5.4 Building Innovations.....	64
5.4.1 The Need for Innovations .....	64
5.4.2 Framed Tube System.....	64
5.4.3 Deep Spandrel Plates .....	64
5.4.4 Uniform External Column Geometry .....	65
5.4.5 Wind Tunnel Test Data to Establish Wind Loads .....	65
5.4.6 Viscoelastic Dampers .....	65

5.4.7	Long-Span Composite Floor Assemblies .....	66
5.4.8	Vertical Shaft Wall Panels.....	66
5.5	Structural Steels .....	67
5.5.1	Types and Sources.....	67
5.5.2	Properties.....	67
5.6	Fire Protection of Structural Steel.....	69
5.6.1	Thermal Insulation .....	69
5.6.2	Use of Insulation in the WTC Towers.....	69
5.7	Concrete .....	75
5.8	The Tenant Spaces .....	75
5.8.1	General .....	75
5.8.2	Walls.....	76
5.8.3	Flooring .....	76
5.8.4	Ceilings.....	76
5.8.5	Furnishings .....	76
<b>Chapter 6</b>		
<b>Reconstruction of the Collapses .....</b>		<b>81</b>
6.1	Approach.....	81
6.2	Development of the Disaster Timeline .....	82
6.3	Learning from the Visual Images .....	84
6.4	Learning from the Recovered Steel .....	86
6.4.1	Collection of Recovered Steel .....	86
6.4.2	Mechanical and Physical Properties.....	88
6.4.3	Damage Analysis.....	89
6.5	Information Gained from Other WTC Fires .....	91
6.6	The Building Structural Models.....	92
6.6.1	Computer Simulation Software .....	92
6.6.2	The Reference Models.....	92
6.6.3	Building Structural Models for Aircraft Impact Analysis .....	94
6.6.4	Building Structural Models for Structural Response to Impact Damage and Fire and Collapse Initiation Analysis .....	97
6.7	The Aircraft Structural Model .....	105
6.8	Aircraft Impact Modeling .....	107
6.8.1	Component Level Analyses.....	107
6.8.2	Subassembly Impact Analyses .....	108

6.8.3	Aircraft Impact Conditions.....	108
6.8.4	Global Impact Analysis .....	109
6.9	Aircraft Impact Damage Estimates .....	112
6.9.1	Structural and Contents Damage .....	112
6.9.2	Validity of Impact Simulations .....	116
6.9.3	Damage to Thermal Insulation .....	119
6.9.4	Damage to Ceiling System .....	120
6.9.5	Damage to Interior Walls and Furnishings.....	120
6.10	Thermal Environment Modeling.....	121
6.10.1	Need for Simulation .....	121
6.10.2	Modeling Approach.....	121
6.10.3	The Four Cases .....	126
6.10.4	Characterization of the Fires .....	127
6.10.5	Global Heat Release Rates .....	130
6.11	Data Transfer .....	131
6.12	Thermal Mapping .....	131
6.12.1	Approach .....	131
6.12.2	The Fire-Structure Interface .....	131
6.12.3	Thermal Insulation Properties .....	132
6.12.4	FSI Uncertainty Assessment.....	133
6.12.5	The Four Cases .....	138
6.12.6	Characterization of the Thermal Profiles.....	141
6.13	Measurement of the Fire Resistance of the Floor System .....	141
6.14	Collapse Analysis of the Towers .....	143
6.14.1	Approach to Determining the Probable Collapse Sequences .....	143
6.14.2	Results of Global Analysis of WTC 1 .....	144
6.14.3	Results of Global Analysis of WTC 2.....	145
6.14.4	Events Following Collapse Initiation .....	146
6.14.5	Structural Response of the WTC Towers to Fire without Impact or Thermal Insulation Damage.....	146
6.14.6	Probable WTC 1 Collapse Sequence.....	150
6.14.7	Probable WTC 2 Collapse Sequence.....	151
6.14.8	Accuracy of the Probable Collapse Sequences.....	152
6.14.9	Factors that Affected Building Performance on September 11, 2001 .....	154

## Chapter 7

<b>Reconstruction of Human Activity .....</b>	<b>155</b>
7.1 Building Occupants.....	155
7.1.1 Background .....	155
7.1.2 The Building Egress System .....	155
7.1.3 The Evacuation—Data Sources.....	157
7.1.4 Occupant Demographics .....	158
7.1.5 Evacuation of WTC 1 .....	158
7.1.6 Evacuation of WTC 2.....	160
7.2 Emergency Responders.....	163
7.2.1 Data Gathered.....	163
7.2.2 Operation Changes following the WTC 1 Bombing on February 26, 1993.....	164
7.2.3 Responder Organization .....	166
7.2.4 Responder Access.....	169
7.2.5 Communications.....	170
7.2.6 The Overall Response .....	172
7.3 Factors That Contributed to Enhanced Life Safety.....	172
7.3.1 Aggregate Factors.....	172
7.3.2 Individual Factors.....	172

**Part III: The Outcome of the Investigation..... 173**

## Chapter 8

<b>Principal Findings.....</b>	<b>175</b>
8.1 Introduction.....	175
8.2 Summary .....	175
8.3 Findings on the Mechanisms of Building Collapse .....	179
8.3.1 Summary of Probable Collapse Sequences .....	179
8.3.2 Structural Steels.....	180
8.3.3 Aircraft Impact Damage Analysis .....	182
8.3.4 Reconstruction of the Fires.....	183
8.3.5 Structural Response and Collapse Analysis .....	185
8.4 Findings on Factors Affecting Life Safety.....	186
8.4.1 Active Fire Protection .....	186
8.4.2 Evacuation .....	188
8.4.3 Emergency Response .....	191

8.5 Findings on Operational Codes, Standards, and Practices .....	194
8.5.1 General .....	194
8.5.2 Structural Safety .....	195
8.5.3 Fire Safety .....	196
8.6 Future Factors That Could Have Improved Life Safety .....	199
8.6.1 Building Performance Factors .....	200
8.6.2 Human Performance Factors .....	200
 Chapter 9	
<b>Recommendations .....</b>	<b>201</b>
9.1 Building Regulations .....	201
9.2 NIST’s Recommendations for Improving the Safety of Buildings, Occupants, and Emergency Responders.....	202
9.2.1 Group 1. Increased Structural Integrity .....	205
9.2.2 Group 2. Enhanced Fire Endurance of Structures .....	208
9.2.3 Group 3. New Methods for Fire Resistant Design of Structures .....	211
9.2.4 Group 4. Improved Active Fire Protection.....	213
9.2.5 Group 5. Improved Building Evacuation .....	214
9.2.6 Group 6. Improved Emergency Response .....	218
9.2.7 Group 7. Improved Procedures and Practices .....	220
9.2.8 Group 8. Education and Training .....	222
9.3 Next Steps .....	223
 <b>Appendix A</b>	
<b>National Construction Safety Team Act</b>	
 <b>Appendix B</b>	
<b>World Trade Center Investigation Publications</b>	
 <b>Appendix C</b>	
<b>Subject Index of Supporting Investigation Reports</b>	

## LIST OF FIGURES

---

Figure P–1.	The eight projects in the federal building and fire safety investigation of the WTC disaster. ....	xxxi
Figure 1–1.	The World Trade Center in Lower Manhattan.....	3
Figure 1–2.	Lower Manhattan and the World Trade Center towers.....	4
Figure 1–3.	Tower floor plans with column numbers. ....	7
Figure 1–4.	Perimeter column/spandrel assembly and floor structure. ....	8
Figure 1–5.	Plan of the 96 <sup>th</sup> floor of WTC 1 showing the core and tenant spaces. ....	9
Figure 1–6.	Schematic of composite floor truss system.....	10
Figure 1–7.	Schematic of a hat truss. ....	11
Figure 1–8.	Photograph of insulated WTC trusses.....	12
Figure 1–9.	Schematic of the three-tier elevator system. ....	14
Figure 1–10.	Orientation of the three stairwells. ....	16
Figure 1–11.	Views of typical WTC office floors.....	17
Figure 1–12.	A WTC trading floor.....	17
Figure 2–1.	Simulated impact of American Airlines Flight 11 with WTC 1. ....	19
Figure 2–2.	Aircraft entry hole on the north side of WTC 1, photographed 30 s after impact. ....	21
Figure 2–3.	South face damage of WTC 1 with key aircraft component locations marked.....	22
Figure 2–4.	Simulation of cumulative aircraft impact damage to floors 93 through 98 in WTC 1.....	23
Figure 2–5.	Representation of exterior views of the fires on the four faces of WTC 1 from 8:47 a.m. to about 9:02 a.m.....	25
Figure 2–6.	Firefighters on the scene at about 9:07 a.m.....	27
Figure 2–7.	Representation of exterior views of the fires on the four faces of WTC 1 from about 9:38 a.m. to 9:58 a.m. ....	28
Figure 2–8.	Steel surface temperatures on the bottom chords of fire-exposed trusses, uninsulated and insulated with ¾ in. of BLAZE-SHIELD DC/F.....	29
Figure 2–9.	Temperature dependence of yield strength of structural steel as a fraction of the value at room temperature. ....	30
Figure 2–10.	Simulated temperatures of two adjacent trusses (left) and two adjacent perimeter columns (right) exposed to the fires in WTC 1.....	30
Figure 2–11.	Temperature contours (°C) on the top and bottom faces of the concrete slab (96 <sup>th</sup> floor, WTC 1) at 100 min after impact. A portion of the concrete slab on the north face (top) was damaged by the impact of the aircraft. ....	31

Figure 2–12. South face of WTC 1 at 10:23 a.m., showing inward buckling (in inches) of perimeter columns..... 33

Figure 3–1. Imminent impact of United Airlines Flight 175 with WTC 2..... 38

Figure 3–2. South face damage of WTC 2 with key aircraft component locations marked..... 39

Figure 3–3. Simulation of aircraft impact damage to the 78<sup>th</sup> through 83<sup>rd</sup> floors in WTC 2. .... 40

Figure 3–4. Representation of exterior views of the fires on the four faces of WTC 2 at about 9:20 a.m..... 43

Figure 3–5. Photograph of WTC 2 tilting to the southeast at the onset of collapse. .... 45

Figure 4–1. The WTC site on September 17, 2001..... 47

Figure 5–1. Fire Command Desk in WTC 1, as seen from a mezzanine elevator, looking west. .... 61

Figure 5–2. Schematic of sprinkler and standpipe systems..... 63

Figure 5–3. Diagram of floor truss showing viscoelastic damper. .... 66

Figure 5–4. Ratio of measured yield strength ( $F_y$ ) to specified minimum yield strength for steels used in WTC perimeter columns. .... 69

Figure 5–5. Irregularity of coating thickness and gaps in coverage on SFRM-coated bridging trusses..... 71

Figure 5–6. Thermal insulation for perimeter columns..... 72

Figure 5–7. Temperature-dependent concrete properties. .... 75

Figure 5–8. A WTC workstation..... 76

Figure 6–1. 9:26:20 a.m. showing the east face of WTC 2. .... 85

Figure 6–2. Close-up of section of Figure 6–1..... 86

Figure 6–3. Examples of a WTC 1 core column (left) and truss material (right)..... 88

Figure 6–4. WTC 1 exterior panel hit by the fuselage of the aircraft..... 88

Figure 6–5. WTC 1 exterior panel hit by the nose of the aircraft..... 89

Figure 6–6. Structural model of the 96<sup>th</sup> floor of WTC 1..... 95

Figure 6–7. Model of the 96<sup>th</sup> floor of WTC 1, including interior contents and partitions. .... 95

Figure 6–8. Multi-floor global model of WTC 1, viewed from the north. .... 96

Figure 6–9. Multi-floor global model of WTC 2, viewed from the south..... 96

Figure 6–10. Finite element model of an exterior truss seat. .... 98

Figure 6–11. Vertical displacement at 700 °C..... 98

Figure 6–12. ANSYS model of 96<sup>th</sup> floor of WTC 1. .... 99

Figure 6–13. Finite element model of the Boeing 767-200ER..... 105



Figure 6–14. Pratt & Whitney PW4000 turbofan engine model. ....	106
Figure 6–15. Boeing 767-200ER showing the jet fuel distribution at time of impact.....	106
Figure 6–16. Calculated impact on an exterior wall by a fuel-laden wing section. ....	107
Figure 6–17. Response of a tower subassembly model to engine impact. ....	108
Figure 6–18. Side view of simulated aircraft impact into WTC 1, Case B. ....	110
Figure 6–19. Column damage levels. ....	112
Figure 6–20. Case B damage to the slab of floor 96 of WTC 1. ....	112
Figure 6–21. Case B simulation of response of contents of 96 <sup>th</sup> floor of WTC 1. ....	113
Figure 6–22. Combined structural damage to the floors and columns of WTC 1, Case A. ....	114
Figure 6–23. Combined structural damage to the floors and columns of WTC 1, Case B. ....	114
Figure 6–24. Combined structural damage to the floors and columns of WTC 2, Case C. ....	115
Figure 6–25. Combined structural damage to the floors and columns of WTC 2, Case D. ....	115
Figure 6–26. Observed and Case A calculated damage to the north face of WTC 1. ....	117
Figure 6–27. Schematic of observed damage (top) and Case A calculated damage (lower) to the north face of WTC 1. ....	118
Figure 6–28. Schematic of observed damage (above) and Case C calculated damage (right) to the south face of WTC 2. ....	118
Figure 6–29. Ceiling tile system mounted on the shaking table.....	120
Figure 6–30. Eight floor model of WTC 1 prior to aircraft impact.....	122
Figure 6–31. Fire test of a single workstation. ....	123
Figure 6–32. Interior view of a three-workstation fire test.....	124
Figure 6–33. Rubblized workstations.....	124
Figure 6–34. Three-workstation fire test, 2 min after the start.....	125
Figure 6–35. Measured and predicted heat release rate from the burning of three office workstations.....	125
Figure 6–36. Upper layer temperatures on the 94 <sup>th</sup> floor of WTC 1, 15 min after impact. ....	127
Figure 6–37. Direction of simulated fire movement on floors 94 and 97 of WTC 1. ....	128
Figure 6–38. Predicted heat release rates for fires in WTC 1 and WTC 2. ....	130
Figure 6–39. Simple bar dimensions (in.). ....	134
Figure 6–40. Tubular column dimensions (in.). ....	134
Figure 6–41. Truss Dimensions (in.). ....	135
Figure 6–42. SFRM-coated steel components prior to a test. ....	135
Figure 6–43. Finite element representation of the insulated steel truss (blue), the SFRM (violet), and the ceiling (red). ....	136
Figure 6–44. Comparison of numerical simulations with measurements for the steel surface temperature at four locations on the top chord of a bare truss. ....	137

Figure 6–45. Comparison of numerical simulations with measurements for the temperature of the steel surface at four locations on the top chord of an insulated truss..... 137

Figure 6–46. Temperatures (°C) on the columns and trusses of the 96<sup>th</sup> floor of WTC 1 at 6,000 s after aircraft impact, Case B. .... 139

Figure 6–47. Temperatures (°C) on the columns and trusses of the 81<sup>st</sup> floor of WTC 2 at 3,000 s after aircraft impact, Case D. .... 139

Figure 6–48. Frames from animation of the thermal response of columns on the 96<sup>th</sup> floor of WTC 1, Case A..... 140

Figure 7–1. Simulated impact damage to 95<sup>th</sup> floor of WTC 1, including stairwells, 0.7 s after impact..... 156

Figure 7–2. Simulated impact damage to WTC 2 on floor 78, 0.62 s after impact..... 156

Figure 7–3. Observations of building damage after initial awareness but before beginning evacuation in WTC 1. .... 161

Figure 7–4. Observations of building damage from tenant spaces in WTC 2..... 162

Figure 7–5. Location of the radio repeater. .... 165

Figure 7–6. Timing of FDNY unit arrivals. .... 166

Figure 7–7. Fire Command Board located in the lobby of WTC 1. .... 168

## LIST OF TABLES

---

Table P-1.	Federal building and fire safety investigation of the WTC disaster.....	xxx
Table P-2.	Public meetings and briefings of the WTC Investigation. ....	xxxiii
Table E-1.	Topics of NIST recommendations for improved public safety in tall and high-risk buildings.....	xliv
Table 1-1.	Use of floors in the WTC towers. ....	5
Table 2-1.	Locations of occupants of WTC 1. ....	26
Table 3-1.	Tenants on impact floors in WTC 2.....	39
Table 3-2.	Location of occupants of WTC 2.....	42
Table 4-1.	Likely locations of WTC decedents at time of impact.....	48
Table 5-1.	Specified steel grades for various applications. ....	67
Table 5-2.	Types and locations of SFRM on fire floors.....	74
Table 5-3.	Floors of focus. ....	78
Table 6-1.	Times for major events on September 11, 2001.....	84
Table 6-2.	Indications of major structural changes up to collapse initiation.....	87
Table 6-3.	Measured and calculated natural vibration periods (s) for WTC 1.....	93
Table 6-4.	Summary of aircraft impact conditions.....	108
Table 6-5.	Input parameters for global impact analyses.....	109
Table 6-6.	Values of WTC fire simulation variables.....	126
Table 6-7.	Summary of insulation on steel components. ....	136
Table 6-8.	Regions in WTC 1 in which temperatures of structural steel exceeded 600 °C. ....	141
Table 6-9.	Regions in WTC 2 in which temperatures of structural steel exceeded 600 °C. ....	141
Table 6-10.	Comparison of global structural model predictions and observations for WTC 1, Case B. ....	153
Table 6-11.	Comparison of global structural model predictions and observations for WTC 2, Case D.....	153

This page intentionally left blank.

## LIST OF ACRONYMS AND ABBREVIATIONS

---

### Acronyms

AA	American Airlines
ARA	Application Research Associates
ASTM	ASTM International
BOCA	Building Officials and Code Administrators
BPS	Building Performance Study
FCD	Fire Command Desk
FDNY	The Fire Department of the City of New York
FDS	Fire Dynamics Simulator
FEMA	Federal Emergency Management Agency
FSI	Fire Structure Interface
IBC	International Building Code
LERA	Leslie E. Robertson Associates
NFPA	National Fire Protection Association
NIST	National Institute of Standards and Technology
NYC	New York City
NYPD	New York City Police Department
NYS	New York State
PANYNJ	The Port Authority of New York and New Jersey
PAPD	Port Authority Police Department
SFRM	sprayed fire-resistive material
SGH	Simpson Gumpertz & Heger, Inc.
SOM	Skidmore, Owings and Merrill
UA	United Airlines
USC	United States Code
WSHJ	Worthington, Skilling, Helle and Jackson
WTC	World Trade Center
WTC 1	World Trade Center 1 (North Tower)

WTC 2	World Trade Center 2 (South Tower)
WTC 7	World Trade Center 7

### Abbreviations and Conversion Factors

°C	degrees Celsius	$T (^{\circ}\text{C}) = 5/9 [T (^{\circ}\text{F}) - 32]$
°F	degrees Fahrenheit	
ft	feet	
gal	gallon	$1 \text{ gal} = 3.78 \times 10^{-3} \text{ m}^3$
GJ	gigajoule	
GW	gigawatt	
in.	inch	
kg	kilogram	
kip	1,000 lb	
ksi	1,000 lb/in. <sup>2</sup>	
lb	pound	$1 \text{ lb} = 0.453 \text{ kg}$
m	meter	$1 \text{ m} = 3.28 \text{ ft}$
μm	micrometer	
min	minute	
MJ	megajoule	
MW	megawatt	
psi	pounds per square inch	
s	second	
T	temperature	

# PREFACE

---

## Genesis of This Investigation

Immediately following the terrorist attack on the World Trade Center (WTC) on September 11, 2001, the Federal Emergency Management Agency (FEMA) and the American Society of Civil Engineers began planning a building performance study of the disaster. The week of October 7, as soon as the rescue and search efforts ceased, the Building Performance Study Team went to the site and began its assessment. This was to be a brief effort, as the study team consisted of experts who largely volunteered their time away from their other professional commitments. The Building Performance Study Team issued its report in May 2002, fulfilling its goal “to determine probable failure mechanisms and to identify areas of future investigation that could lead to practical measures for improving the damage resistance of buildings against such unforeseen events.”

On August 21, 2002, with funding from the U.S. Congress through FEMA, the National Institute of Standards and Technology (NIST) announced its building and fire safety investigation of the WTC disaster. On October 1, 2002, the National Construction Safety Team Act (Public Law 107-231), was signed into law. (A copy of the Public Law is included in Appendix A). The NIST WTC Investigation was conducted under the authority of the National Construction Safety Team Act.

The goals of the investigation of the WTC disaster were:

- To investigate the building construction, the materials used, and the technical conditions that contributed to the outcome of the WTC disaster.
- To serve as the basis for:
  - Improvements in the way buildings are designed, constructed, maintained, and used;
  - Improved tools and guidance for industry and safety officials;
  - Recommended revisions to current codes, standards, and practices; and
  - Improved public safety.

The specific objectives were:

1. Determine why and how WTC 1 and WTC 2 collapsed following the initial impacts of the aircraft and why and how WTC 7 collapsed;
2. Determine why the injuries and fatalities were so high or low depending on location, including all technical aspects of fire protection, occupant behavior, evacuation, and emergency response;
3. Determine what procedures and practices were used in the design, construction, operation, and maintenance of WTC 1, 2, and 7; and
4. Identify, as specifically as possible, areas in current building and fire codes, standards, and practices that warrant revision.

NIST is a nonregulatory agency of the U.S. Department of Commerce’s Technology Administration. The purpose of NIST investigations is to improve the safety and structural integrity of buildings in the United States, and the focus is on fact finding. NIST investigative teams are authorized to assess building performance and emergency response and evacuation procedures in the wake of any building failure that has resulted in substantial loss of life or that posed significant potential of substantial loss of life. NIST does not have the statutory authority to make findings of fault nor negligence by individuals or organizations. Further, no part of any report resulting from a NIST investigation into a building failure or from an investigation under the National Construction Safety Team Act may be used in any suit or action for damages arising out of any matter mentioned in such report (15 USC 281a, as amended by Public Law 107-231).

### Organization of the Investigation

The National Construction Safety Team for this Investigation, appointed by the then NIST Director, Dr. Arden L. Bement, Jr., was led by Dr. S. Shyam Sunder. Dr. William L. Grosshandler served as Associate Lead Investigator, Mr. Stephen A. Cauffman served as Program Manager for Administration, and Mr. Harold E. Nelson served on the team as a private sector expert. The Investigation included eight interdependent projects whose leaders comprised the remainder of the team. A detailed description of each of these eight projects is available at <http://wtc.nist.gov>. The purpose of each project is summarized in Table P–1, and the key interdependencies among the projects are illustrated in Fig. P–1.

**Table P–1. Federal building and fire safety investigation of the WTC disaster.**

Technical Area and Project Leader	Project Purpose
Analysis of Building and Fire Codes and Practices; Project Leaders: Dr. H. S. Lew and Mr. Richard W. Bukowski	Document and analyze the code provisions, procedures, and practices used in the design, construction, operation, and maintenance of the structural, passive fire protection, and emergency access and evacuation systems of WTC 1, 2, and 7.
Baseline Structural Performance and Aircraft Impact Damage Analysis; Project Leader: Dr. Fahim H. Sadek	Analyze the baseline performance of WTC 1 and WTC 2 under design, service, and abnormal loads, and aircraft impact damage on the structural, fire protection, and egress systems.
Mechanical and Metallurgical Analysis of Structural Steel; Project Leader: Dr. Frank W. Gayle	Determine and analyze the mechanical and metallurgical properties and quality of steel, weldments, and connections from steel recovered from WTC 1, 2, and 7.
Investigation of Active Fire Protection Systems; Project Leader: Dr. David D. Evans; Dr. William Grosshandler	Investigate the performance of the active fire protection systems in WTC 1, 2, and 7 and their role in fire control, emergency response, and fate of occupants and responders.
Reconstruction of Thermal and Tenability Environment; Project Leader: Dr. Richard G. Gann	Reconstruct the time-evolving temperature, thermal environment, and smoke movement in WTC 1, 2, and 7 for use in evaluating the structural performance of the buildings and behavior and fate of occupants and responders.
Structural Fire Response and Collapse Analysis; Project Leaders: Dr. John L. Gross and Dr. Therese P. McAllister	Analyze the response of the WTC towers to fires with and without aircraft damage, the response of WTC 7 in fires, the performance of composite steel-trussed floor systems, and determine the most probable structural collapse sequence for WTC 1, 2, and 7.
Occupant Behavior, Egress, and Emergency Communications; Project Leader: Mr. Jason D. Averill	Analyze the behavior and fate of occupants and responders, both those who survived and those who did not, and the performance of the evacuation system.
Emergency Response Technologies and Guidelines; Project Leader: Mr. J. Randall Lawson	Document the activities of the emergency responders from the time of the terrorist attacks on WTC 1 and WTC 2 until the collapse of WTC 7, including practices followed and technologies used.



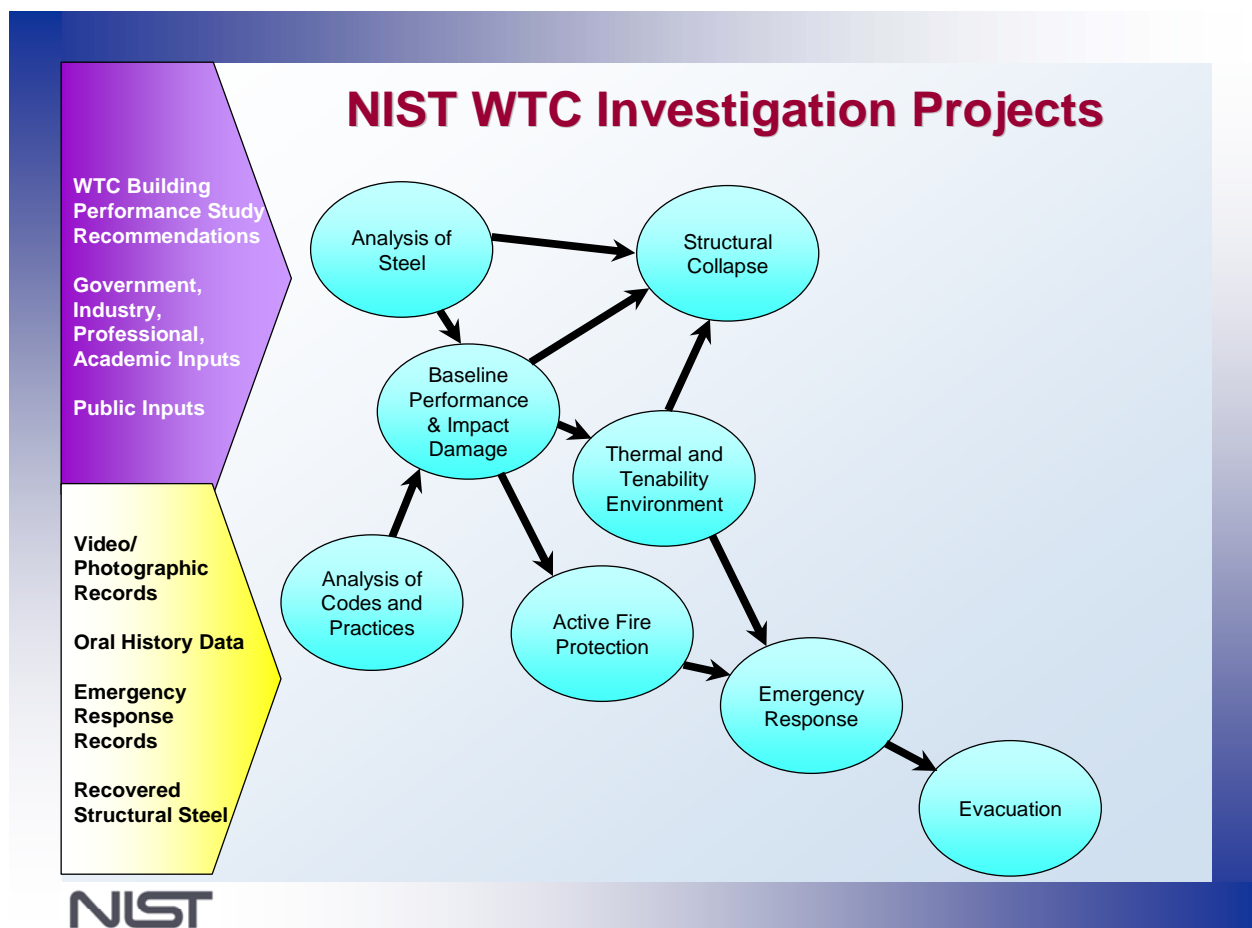

**Figure P–1. The eight projects in the federal building and fire safety investigation of the WTC disaster.**

### National Construction Safety Team Advisory Committee

The NIST Director also established an advisory committee as mandated under the National Construction Safety Team Act. The initial members of the committee were appointed following a public solicitation. These were:

- Paul Fitzgerald, Executive Vice President (retired) FM Global, National Construction Safety Team Advisory Committee Chair
- John Barsom, President, Barsom Consulting, Ltd.
- John Bryan, Professor Emeritus, University of Maryland
- David Collins, President, The Preview Group, Inc.
- Glenn Corbett, Professor, John Jay College of Criminal Justice
- Philip DiNunno, President, Hughes Associates, Inc.

- Robert Hanson, Professor Emeritus, University of Michigan
- Charles Thornton, Co-Chairman and Managing Principal, The Thornton-Tomasetti Group, Inc.
- Kathleen Tierney, Director, Natural Hazards Research and Applications Information Center, University of Colorado at Boulder
- Forman Williams, Director, Center for Energy Research, University of California at San Diego

This National Construction Safety Team Advisory Committee provided technical advice during the Investigation and commentary on drafts of the Investigation reports prior to their public release. NIST has benefited from the work of many people in the preparation of these reports, including the National Construction Safety Team Advisory Committee. The content of the reports and recommendations, however, are solely the responsibility of NIST.

### **Public Outreach**

During the course of this Investigation, NIST held public briefings and meetings (listed in Table P–2) to solicit input from the public, present preliminary findings, and obtain comments on the direction and progress of the Investigation from the public and the Advisory Committee.

NIST maintained a publicly accessible Web site during this Investigation at <http://wtc.nist.gov>. The site contained extensive information on the background and progress of the Investigation.

### **NIST's WTC Public-Private Response Plan**

The collapse of the WTC buildings has led to broad reexamination of how tall buildings are designed, constructed, maintained, and used, especially with regard to major events such as fires, natural disasters, and terrorist attacks. Reflecting the enhanced interest in effecting necessary change, NIST, with support from Congress and the Administration, has put in place a program, the goal of which is to develop and implement the standards, technology, and practices needed for cost-effective improvements to the safety and security of buildings and building occupants, including evacuation, emergency response procedures, and threat mitigation.

The strategy to meet this goal is a three-part, NIST-led, public-private response program that includes:

- A federal building and fire safety investigation to study the most probable factors that contributed to post-aircraft impact collapse of the WTC towers and the 47-story WTC 7 building, and the associated evacuation and emergency response experience.
- A research and development (R&D) program to (a) facilitate the implementation of recommendations resulting from the WTC Investigation, and (b) provide the technical basis for cost-effective improvements to national building and fire codes, standards, and practices that enhance the safety of buildings, their occupants, and emergency responders.

**Table P-2. Public meetings and briefings of the WTC Investigation.**

<b>Date</b>	<b>Location</b>	<b>Principal Agenda</b>
June 24, 2002	New York City, NY	Public meeting: Public comments on the <i>Draft Plan</i> for the pending WTC Investigation.
August 21, 2002	Gaithersburg, MD	Media briefing announcing the formal start of the Investigation.
December 9, 2002	Washington, DC	Media briefing on release of the <i>Public Update</i> and NIST request for photographs and videos.
April 8, 2003	New York City, NY	Joint public forum with Columbia University on first-person interviews.
April 29–30, 2003	Gaithersburg, MD	NCST Advisory Committee meeting on plan for and progress on WTC Investigation with a public comment session.
May 7, 2003	New York City, NY	Media briefing on release of <i>May 2003 Progress Report</i> .
August 26–27, 2003	Gaithersburg, MD	NCST Advisory Committee meeting on status of the WTC investigation with a public comment session.
September 17, 2003	New York City, NY	Media and public briefing on initiation of first-person data collection projects.
December 2–3, 2003	Gaithersburg, MD	NCST Advisory Committee meeting on status and initial results and release of the <i>Public Update</i> with a public comment session.
February 12, 2004	New York City, NY	Public meeting on progress and preliminary findings with public comments on issues to be considered in formulating final recommendations.
June 18, 2004	New York City, NY	Media/public briefing on release of <i>June 2004 Progress Report</i> .
June 22–23, 2004	Gaithersburg, MD	NCST Advisory Committee meeting on the status of and preliminary findings from the WTC Investigation with a public comment session.
August 24, 2004	Northbrook, IL	Public viewing of standard fire resistance test of WTC floor system at Underwriters Laboratories, Inc.
October 19–20, 2004	Gaithersburg, MD	NCST Advisory Committee meeting on status and near complete set of preliminary findings with a public comment session.
November 22, 2004	Gaithersburg, MD	NCST Advisory Committee discussion on draft annual report to Congress, a public comment session, and a closed session to discuss pre-draft recommendations for WTC Investigation.
April 5, 2005	New York City, NY	Media and public briefing on release of the probable collapse sequence for the WTC towers and draft reports for the projects on codes and practices, evacuation, and emergency response.
June 23, 2005	New York City, NY	Media and public briefing on release of all draft reports for the WTC towers and draft recommendations for public comment.
September 12–13, 2005	Gaithersburg, MD	NCST Advisory Committee meeting on disposition of public comments and update to draft reports for the WTC towers.
September 13–15, 2005	Gaithersburg, MD	WTC Technical Conference for stakeholders and technical community for dissemination of findings and recommendations and opportunity for the public to make technical comments.

- A dissemination and technical assistance program (DTAP) to (a) engage leaders of the construction and building community in ensuring timely adoption and widespread use of proposed changes to practices, standards, and codes resulting from the WTC Investigation and the R&D program, and (b) provide practical guidance and tools to better prepare facility owners, contractors, architects, engineers, emergency responders, and regulatory authorities to respond to future disasters.

The desired outcomes are to make buildings, occupants, and first responders safer in future disaster events.

## **National Construction Safety Team Reports on the WTC Investigation**

This report covers the WTC towers, with a separate report on the 47-story WTC 7. Supporting documentation of the techniques and technologies used in the reconstruction are in a set of companion reports that provide more detailed documentation of the Investigation findings and the means by which these technical results were achieved. As such, they are part of the archival record of this Investigation. The titles of the full set of Investigation publications are listed in Appendix B.

# EXECUTIVE SUMMARY

---

## E.1 GENESIS OF THIS INVESTIGATION

On August 21, 2002, the National Institute of Standards and Technology (NIST) announced its building and fire safety investigation of the World Trade Center (WTC) disaster.<sup>1</sup> This WTC Investigation was then conducted under the authority of the National Construction Safety Team (NCST) Act, which was signed into law on October 1, 2002. A copy of the Public Law is included in Appendix A.

The goals of the investigation of the WTC disaster were:

- To investigate the building construction, the materials used, and the technical conditions that contributed to the outcome of the WTC disaster after terrorists flew large jet-fuel laden commercial airliners into the WTC towers.
- To serve as the basis for:
  - Improvements in the way buildings are designed, constructed, maintained, and used;
  - Improved tools and guidance for industry and safety officials;
  - Recommended revisions to current codes, standards, and practices; and
  - Improved public safety

The specific objectives were:

1. Determine why and how WTC 1 and WTC 2 collapsed following the initial impacts of the aircraft and why and how WTC 7 collapsed;
2. Determine why the injuries and fatalities were so high or low depending on location, including all technical aspects of fire protection, occupant behavior, evacuation, and emergency response;
3. Determine what procedures and practices were used in the design, construction, operation, and maintenance of WTC 1, 2, and 7; and

---

<sup>1</sup> NIST is a nonregulatory agency of the U.S. Department of Commerce. The purpose of NIST investigations is to improve the safety and structural integrity of buildings in the United States, and the focus is on fact finding. NIST investigative teams are authorized to assess building performance and emergency response and evacuation procedures in the wake of any building failure that has resulted in substantial loss of life or that posed significant potential of substantial loss of life. NIST does not have the statutory authority to make findings of fault nor negligence by individuals or organizations. Further, no part of any report resulting from a NIST investigation into a building failure or from an investigation under the National Construction Safety Team Act may be used in any suit or action for damages arising out of any matter mentioned in such report (15 USC 281a, as amended by P.L. 107-231).

4. Identify, as specifically as possible, areas in current building and fire codes, standards, and practices that warrant revision.

## E.2 APPROACH

To meet these goals, NIST complemented its in-house expertise with an array of specialists in key technical areas. In all, over 200 staff contributed to the Investigation. NIST and its contractors compiled and reviewed tens of thousand of pages of documents; conducted interviews with over a thousand people who had been on the scene or who had been involved with the design, construction, and maintenance of the WTC; analyzed 236 pieces of steel that were obtained from the wreckage; performed laboratory tests, measured material properties, and performed computer simulations of the sequence of events that happened from the instant of aircraft impact to the initiation of collapse for each tower.

Cooperation in obtaining the resource materials and in interpreting the results came from a large number of individuals and organizations, including The Port Authority of New York and New Jersey and its contractors and consultants; Silverstein Properties and its contractors and consultants; the City of New York and its departments; the manufacturers and fabricators of the building components; the companies that insured the WTC towers; the building tenants; the aircraft manufacturers; the airlines; the public, including survivors and family members; and the media.

The scarcity of physical evidence that is typically available in place for reconstruction of a disaster led to the following approach:

- Accumulation of copious photographic and video material. With the assistance of the media, public agencies and individual photographers, NIST acquired and organized nearly 7,000 segments of video footage, totaling in excess of 150 hours and nearly 7,000 photographs representing at least 185 photographers. This guided the Investigation Team's efforts to determine the condition of the buildings following the aircraft impact, the evolution of the fires, and the subsequent deterioration of the structure.
- Establishment of the baseline performance of the WTC towers, i.e., estimating the expected performance of the towers under normal design loads and conditions. The baseline performance analysis also helped to estimate the ability of the towers to withstand the unexpected events of September 11, 2001. Establishing the baseline performance of the towers began with the compilation and analysis of the procedures and practices used in the design, construction, operation, and maintenance of the structural, fire protection, and egress systems of the WTC towers. The additional components of the performance analysis were the standard fire resistance of the WTC truss-framed floor system, the quality and properties of the structural steels used in the towers, and the response of the WTC towers to the design gravity and wind loads.
- Simulations of the behavior of each tower on September 11, 2001, in four steps:
  1. The aircraft impact into the tower, the resulting distribution of aviation fuel, and the damage to the structure, partitions, thermal insulation materials, and building contents.
  2. The evolution of multi-floor fires.

3. The heating and consequent weakening of the structural elements by the fires.
4. The response of the damaged and heated building structure, and the progression of structural component failures leading to the initiation of the collapse of the towers.

For such complex structures and complex thermal and structural processes, each of these steps stretched the state of the technology and tested the limits of software tools and computer hardware. For example, the investigators advanced the state-of-the-art in the measurement of construction material properties and in structural finite element modeling. New modeling capability was developed for the mapping of fire-generated environmental temperatures onto the building structural components.

The output of the four-step simulations was subject to uncertainties in the as-built condition of the towers, the interior layout and furnishings, the aircraft impact, the internal damage to the towers (especially the thermal insulation for fire protection of the structural steel, which is colloquially referred to as *fireproofing*), the redistribution of the combustibles, and the response of the building structural components to the heat from the fires. To increase confidence in the simulation results, NIST used the visual evidence, eyewitness accounts from inside and outside the buildings, laboratory tests involving large fires and the heating of structural components, and formal statistical methods to identify influential parameters and quantify the variability in analysis results.

- Combination of the knowledge gained into probable collapse sequences for each tower,<sup>2</sup> the identification of factors that contributed to the collapse, and a list of factors that could have improved building performance or otherwise mitigated the loss of life.
- Compilation of a list of findings that respond to the first three objectives and a list of recommendations that responds to the fourth objective.

### E.3 SUMMARY OF FINDINGS

#### **Objective 1: Determine why and how WTC 1 and WTC 2 collapsed following the initial impacts of the aircraft.**

- The two aircraft hit the towers at high speed and did considerable damage to principal structural components (core columns, floors, and perimeter columns) that were directly impacted by the aircraft or associated debris. However, the towers withstood the impacts and would have remained standing were it not for the dislodged insulation (fireproofing) and the subsequent multi-floor fires. The robustness of the perimeter frame-tube system and the large size of the buildings helped the towers withstand the impact. The structural system redistributed loads from places of aircraft impact, avoiding larger scale damage upon impact. The hat truss, a feature atop each tower which was intended to support a television antenna, prevented earlier collapse of the building core. In each tower, a different combination of impact damage and heat-weakened structural components contributed to the abrupt structural collapse.

---

<sup>2</sup> The focus of the Investigation was on the sequence of events from the instant of aircraft impact to the initiation of collapse for each tower. For brevity in this report, this sequence is referred to as the “probable collapse sequence,” although it includes little analysis of the structural behavior of the tower after the conditions for collapse initiation were reached and collapse became inevitable.

- In WTC 1, the fires weakened the core columns and caused the floors on the south side of the building to sag. The floors pulled the heated south perimeter columns inward, reducing their capacity to support the building above. Their neighboring columns quickly became overloaded as columns on the south wall buckled. The top section of the building tilted to the south and began its descent. The time from aircraft impact to collapse initiation was largely determined by how long it took for the fires to weaken the building core and to reach the south side of the building and weaken the perimeter columns and floors.
- In WTC 2, the core was damaged severely at the southeast corner and was restrained by the east and south walls via the hat truss and the floors. The steady burning fires on the east side of the building caused the floors there to sag. The floors pulled the heated east perimeter columns inward, reducing their capacity to support the building above. Their neighboring columns quickly became overloaded as columns on the east wall buckled. The top section of the building tilted to the east and to the south and began its descent. The time from aircraft impact to collapse initiation was largely determined by the time for the fires to weaken the perimeter columns and floor assemblies on the east and the south sides of the building. WTC 2 collapsed more quickly than WTC 1 because there was more aircraft damage to the building core, including one of the heavily loaded corner columns, and there were early and persistent fires on the east side of the building, where the aircraft had extensively dislodged insulation from the structural steel.
- The WTC towers likely would not have collapsed under the combined effects of aircraft impact damage and the extensive, multi-floor fires that were encountered on September 11, 2001, if the thermal insulation had not been widely dislodged or had been only minimally dislodged by aircraft impact.
- In the absence of structural and insulation damage, a conventional fire substantially similar to or less intense than the fires encountered on September 11, 2001, likely would not have led to the collapse of a WTC tower.
- NIST found no corroborating evidence for alternative hypotheses suggesting that the WTC towers were brought down by controlled demolition using explosives planted prior to September 11, 2001. NIST also did not find any evidence that missiles were fired at or hit the towers. Instead, photographs and videos from several angles clearly showed that the collapse initiated at the fire and impact floors and that the collapse progressed from the initiating floors downward, until the dust clouds obscured the view.

**Objective 2: Determine why the injuries and fatalities were so high or low depending on location, including all technical aspects of fire protection, occupant behavior, evacuation, and emergency response.**

- Approximately 87 percent of the estimated 17,400 occupants of the towers, and 99 percent of those located below the impact floors, evacuated successfully. In WTC 1, where the aircraft destroyed all escape routes, 1,355 people were trapped in the upper floors when the building collapsed. One hundred seven people who were below the impact floors did not survive. Since the flow of people from the building had slowed considerably 20 min before the tower collapsed, the stairwell capacity was adequate to evacuate the occupants on that morning.



- In WTC 2, before the second aircraft strike, about 3,000 people got low enough in the building to escape by a combination of self-evacuation and use of elevators. The aircraft destroyed the operation of the elevators and the use of two of the three stairways. Eighteen people from above the impact zone found a passage through the damaged third stairway (Stairwell A) and escaped. The other 619 people in or above the impact zone perished. Eleven people who were below the impact floors did not survive. As in WTC 1, shortly before collapse, the flow of people from the building had slowed considerably, indicating that the stairwell capacity was adequate that morning.
- About 6 percent of the survivors described themselves as mobility impaired, with recent injury and chronic illness being the most common causes; few, however, required a wheelchair. Among the 118 decedents below the aircraft impact floors, investigators identified seven who were mobility impaired, but were unable to determine the mobility capability of the remaining 111.
- A principal factor limiting the loss of life was that the buildings were one-third to one-half occupied at the time of the attacks. NIST estimated that if the towers had been fully occupied with 20,000 occupants each, it would have taken just over 3 hours to evacuate the buildings and about 14,000 people might have perished because the stairwell capacity would not have been sufficient to evacuate that many people in the available time. Egress capacity required by current building codes is determined by single floor calculations that are independent of building height and does not consider the time for full building evacuation.
- Due to the presence of assembly use spaces at the top of each tower (Windows on the World restaurant complex in WTC 1 and the Top of the World observation deck in WTC 2) that were designed to accommodate over 1,000 occupants per floor, the New York City Building Code would have required a minimum of four independent means of egress (stairs), one more than the three that were available in the buildings. Given the low occupancy level on September 11, 2001, NIST found that the issue of egress capacity from these places of assembly, or from elsewhere in the buildings, was not a significant factor on that day. It is conceivable that such a fourth stairwell, depending on its location and the effects of aircraft impact on its functional integrity, could have remained passable, allowing evacuation by an unknown number of additional occupants from above the floors of impact. If the buildings had been filled to their capacity with 20,000 occupants, the required fourth stairway would likely have mitigated the insufficient egress capacity for conducting a full building evacuation within the available time.
- Evacuation was assisted by participation in fire drills within the previous year by two-thirds of survivors and perhaps hindered by a Local Law that prevented employers from *requiring* occupants to practice using the stairways. The stairways were not easily navigated in some locations due to their design, which included “transfer hallways,” where evacuees had to traverse from one stairway to another location where the stairs continued. Additionally, many occupants were unprepared for the physical challenge of full building evacuation.
- The functional integrity and survivability of the stairwells was affected by the separation of the stairwells and the structural integrity of stairwell enclosures. In the impact region of WTC 1, the stairwell separation was the smallest over the building height—clustered well

within the building core—and all stairwells were destroyed by the aircraft impact. By contrast, the separation of stairwells in the impact region of WTC 2 was the largest over the building height—located along different boundaries of the building core—and one of three stairwells remained marginally passable after the aircraft impact. The shaft enclosures were fire rated but were not required to have structural integrity under typical accidental loads: there were numerous reports of stairwells obstructed by fallen debris from damaged enclosures.

- The active fire safety systems (sprinklers, smoke purge, fire alarms, and emergency occupant communications) were designed to meet or exceed current practice. However, with the exception of the evacuation announcements, they played no role in the safety of life on September 11 because the water supplies to the sprinklers were damaged by the aircraft impact. The smoke purge systems operated under the direction of the fire department after fires were not turned on, but they also would have been ineffective due to aircraft damage. The violence of the aircraft impact served as its own alarm. In WTC 2, contradictory public address announcements contributed to occupant confusion and some delay in occupants beginning to evacuate.
- For the approximately 1,000 emergency responders on the scene, this was the largest disaster they had even seen. Despite attempts by the responding agencies to work together and perform their own tasks, the extent of the incident was well beyond their capabilities. Communications were erratic due to the high number of calls and the inadequate performance of some of the gear. Even so, there was no way to digest, test for accuracy, and disseminate the vast amount of information being received. Their jobs were complicated by the loss of command centers in WTC 7 and then in the towers after WTC 2 collapsed. With nearly all elevator service disrupted and progress up the stairs taking about 2 min per floor, it would have taken hours for the responders to reach their destinations, assist survivors, and escape had the towers not collapsed.

**Objective 3: Determine what procedures and practices were used in the design, construction, operation, and maintenance of WTC 1 and WTC 2.**

- Because of The Port Authority's establishment under a clause of the United States Constitution, its buildings were not subject to any state or local building regulations. The buildings were unlike any others previously built, both in their height and in their innovative structural features. Nevertheless, the actual design and approval process produced two buildings that generally were consistent with nearly all of the provisions of the New York City Building Code and other building codes of that time that were reviewed by NIST. The loads for which the buildings were designed exceeded the New York City code requirements. The quality of the structural steels was consistent with the building specifications. The departures from the building codes and standards identified by NIST did not have a significant effect on the outcome of September 11.
- For the floor systems, the fire rating and insulation thickness used on the floor trusses, which together with the concrete slab served as the main source of support for the floors, were of concern from the time of initial construction. NIST found no technical basis or test data on which the thermal protection of the steel was based. On September 11, 2001, the minimum

specified thickness of the insulation was adequate to delay heating of the trusses; the amount of insulation dislodged by the aircraft impact, however, was sufficient to cause the structural steel to be heated to critical levels.

- Based on four standard fire resistance tests that were conducted under a range of insulation and test conditions, NIST found the fire rating of the floor system to vary between 3/4 hour and 2 hours; in all cases, the floors continued to support the full design load without collapse for over 2 hours.
- The wind loads used for the WTC towers, which governed the structural design of the external columns and provided the baseline capacity of the structures to withstand abnormal events such as major fires or impact damage, significantly exceeded the requirements of the New York City Building Code and other building codes of the day that were reviewed by NIST. Two sets of wind load estimates for the towers obtained by independent commercial consultants in 2002, however, differed by as much as 40 percent. These estimates were based on wind tunnel tests conducted as part of insurance litigation unrelated to the Investigation.

#### E.4 RECOMMENDATIONS

The tragic consequences of the September 11, 2001, attacks were directly attributable to the fact that terrorists flew large jet-fuel laden commercial airliners into the WTC towers. Buildings for use by the general population are not designed to withstand attacks of such severity; building regulations do not require building designs to consider aircraft impact. In our cities, there has been no experience with a disaster of such magnitude, nor has there been any in which the total collapse of a high-rise building occurred so rapidly and with little warning.

While there were unique aspects to the design of the WTC towers and the terrorist attacks of September 11, 2001, NIST has compiled a list of recommendations to improve the safety of tall buildings, occupants, and emergency responders based on its investigation of the procedures and practices that were used for the WTC towers; these procedures and practices are commonly used in the design, construction, operation, and maintenance of buildings under normal conditions. Public officials and building owners will need to determine appropriate performance requirements for those tall buildings, and selected other buildings, that are at higher risk due to their iconic status, critical function, or design.

The topics of the recommendations in eight groups are listed in Table E-1. The ordering does not reflect any priority.

The eight major groups of recommendations are:

- Increased Structural Integrity: The standards for estimating the load effects of potential hazards (e.g., progressive collapse, wind) and the design of structural systems to mitigate the effects of those hazards should be improved to enhance structural integrity.
- Enhanced Fire Endurance of Structures: The procedures and practices used to ensure the fire endurance of structures should be enhanced by improving the technical basis for construction classifications and fire resistance ratings, improving the technical basis for standard fire resistance testing methods, use of the “structural frame” approach to fire resistance ratings,

and developing in-service performance requirements and conformance criteria for sprayed fire-resistive material.

- New Methods for Fire Resistant Design of Structures: The procedures and practices used in the fire resistant design of structures should be enhanced by requiring an objective that uncontrolled fires result in burnout without local or global collapse. Performance-based methods are an alternative to prescriptive design methods. This effort should include the development and evaluation of new fire resistive coating materials and technologies and evaluation of the fire performance of conventional and high-performance structural materials.
- Improved Active Fire Protection: Active fire protection systems (i.e., sprinklers, standpipes/hoses, fire alarms, and smoke management systems) should be enhanced through improvements to design, performance, reliability, and redundancy of such systems.
- Improved Building Evacuation: Building evacuation should be improved to include system designs that facilitate safe and rapid egress, methods for ensuring clear and timely emergency communications to occupants, better occupant preparedness for evacuation during emergencies, and incorporation of appropriate egress technologies.
- Improved Emergency Response: Technologies and procedures for emergency response should be improved to enable better access to buildings, response operations, emergency communications, and command and control in large-scale emergencies.
- Improved Procedures and Practices: The procedures and practices used in the design, construction, maintenance, and operation of buildings should be improved to include encouraging code compliance by nongovernmental and quasi-governmental entities, adoption and application of egress and sprinkler requirements in codes for existing buildings, and retention and availability of building documents over the life of a building.
- Education and Training: The professional skills of building and fire safety professionals should be upgraded through a national education and training effort for fire protection engineers, structural engineers, architects, and building regulatory and fire service personnel.

The recommendations call for action by specific entities regarding standards, codes and regulations, their adoption and enforcement, professional practices, education, and training; and research and development. Only when each of the entities carries out its role will the implementation of a recommendation be effective.

The recommendations do not prescribe specific systems, materials, or technologies. Instead, NIST encourages competition among alternatives that can meet performance requirements. The recommendations also do not prescribe specific threshold levels; NIST believes that this responsibility properly falls within the purview of the public policy setting process, in which the standards and codes development process plays a key role.

NIST believes the recommendations are realistic and achievable within a reasonable period of time. Only a few of the recommendations call for new requirements in standards and codes. Most of the recommendations deal with improving an existing standard or code requirement, establishing a standard

for an existing practice without one, establishing the technical basis for an existing requirement, making a current requirement risk-consistent, adopting or enforcing a current requirement, or establishing a performance-based alternative to a current prescriptive requirement.

NIST strongly urges that immediate and serious consideration be given to these recommendations by the building and fire safety communities in order to achieve appropriate improvements in the way buildings are designed, constructed, maintained, and used and in evacuation and emergency response procedures—with the goal of making buildings, occupants, and first responders safer in future emergencies.

NIST also strongly urges building owners and public officials to (1) evaluate the safety implications of these recommendations to their existing inventory of buildings and (2) take the steps necessary to mitigate any unwarranted risks without waiting for changes to occur in codes, standards, and practices.

NIST further urges state and local agencies to rigorously enforce building codes and standards since such enforcement is critical to ensure the expected level of safety. Unless they are complied with, the best codes and standards cannot protect occupants, emergency responders, or buildings.

**Table E-1. Topics of NIST recommendations for improved public safety in tall and high-risk buildings.**

Recommendation Group	Recommendation Topic	Responsible Community					Application		Relation to 9/11 Outcome	
		Practices	Regulations, Codes, Standards,	Adoption & Enforcement	R&D/Further Study	Education & Training	All Tall Buildings	Selected Other High-Risk Buildings	Related <sup>a</sup>	Unrelated <sup>b</sup>
Increased Structural Integrity	Prevention of progressive collapse and failure analysis of complex systems	✓	✓	✓	✓	✓	✓	✓		
	Estimation of wind loads and their effects on tall buildings	✓	✓		✓		✓	✓	✓	
	Allowable tall buildings sway	✓	✓		✓		✓		✓	
Enhanced Fire Endurance of Structures	Fire resistance rating requirements and construction classification	✓	✓		✓		✓		✓	
	Fire resistance testing of building components and extrapolation of test data to qualify untested building components		✓		✓		✓		✓	
	In-service performance requirements and inspection procedures for sprayed fire-resistive material (SFRM or spray-on fireproofing)	✓	✓	✓	✓		✓		✓	
	“Structural frame” approach (structural members connected to columns carry the higher fire resistance rating of the columns)		✓	✓		✓	✓		✓	
New Methods for Fire Resistant Design of Structures	Burnout without partial or global (total) structural collapse in uncontrolled building fires	✓	✓	✓	✓	✓	✓	✓		
	Performance-based design and retrofit of structures to resist fires	✓	✓		✓	✓	✓		✓	
	New fire-resistive coating materials, systems, and technologies	✓	✓		✓		✓	✓		
	Evaluation of high performance structural materials under conditions expected in building fires	✓			✓		✓	✓	✓	
Improved Active Fire Protection	Performance and redundancy of active fire protection systems to accommodate the greater risks associated with tall buildings	✓	✓		✓		✓	✓		
	Advanced fire alarm and communication systems that provide continuous, reliable, and accurate information on life safety conditions to manage the evacuation process.		✓		✓		✓		✓	
	Advanced fire/emergency control panels with more reliable information from the active fire protection systems to provide tactical decision aids		✓		✓		✓	✓	✓	
	Improved transmission to emergency responders, and off-site or black box storage, of information from building monitoring systems	✓	✓		✓		✓	✓	✓	

Recommendation Group	Recommendation Topic	Responsible Community					Application		Relation to 9/11 Outcome		
		Practices	Regulations Codes, Standards,	Enforcement	Adoption & Enforcement	R&D/Further Study	Education & Training	All Tall Buildings	Selected Other High-Risk Buildings	Related <sup>a</sup>	Unrelated <sup>b</sup>
Improved Building Evacuation	Public education and training campaigns to improve building occupants' preparedness for evacuation	✓	✓			✓	✓	✓		✓	✓
	Tall building design for timely full building emergency evacuation of occupants	✓	✓			✓	✓	✓	✓	✓	✓
	Design of occupant-friendly evacuation paths that maintain functionality in foreseeable emergencies	✓	✓					✓		✓	
	Planning for communication of accurate emergency information to building occupants	✓	✓				✓	✓	✓	✓	
	Evaluation of alternative evacuation technologies, to allow all occupants equal opportunity for evacuation and to facilitate emergency response access	✓	✓			✓		✓	✓	✓	
Improved Emergency Response	Fire-protected and structurally hardened elevators	✓	✓			✓		✓		✓	
	Effective emergency communications systems for large-scale emergencies	✓	✓	✓		✓	✓	✓		✓	
	Enhanced gathering, processing, and delivering of critical information to emergency responders	✓	✓	✓		✓	✓	✓	✓	✓	
	Effective and uninterrupted operation of the command and control system for large-scale building emergencies	✓	✓	✓		✓	✓	✓		✓	
Improved Procedures and Practices	Provision of code-equivalent level of safety and certification of as-designed and as-built safety by nongovernmental and quasi-governmental entities	✓	✓	✓				✓	✓		✓
	Egress and sprinkler requirements for existing buildings	✓		✓				✓	✓		✓
	Retention and off-site storage of design, construction, maintenance, and modification documents over the entire life of the building; and availability of relevant building information for use by responders in emergencies	✓	✓	✓				✓	✓	✓	
	Design professional responsibility for innovative or unusual structural and fire safety systems	✓	✓				✓	✓	✓	✓	
Education and Training	Professional cross training of fire protection engineers, architects, structural engineers, and building regulatory and fire service personnel.	✓	✓				✓	✓	✓	✓	
	Training in computational fire dynamics and thermostructural analysis	✓					✓	✓	✓		✓

a. If in place, could have changed the outcome on September 11, 2001.

b. Would not have changed the outcome, yet is an important building and fire safety issue that was identified during the course of the Investigation.

This page intentionally left blank.



**PART I: SEPTEMBER 11, 2001**

---

This page intentionally left blank.

# Chapter 1

## NEW YORK CITY'S WORLD TRADE CENTER

---

### 1.1 THE ORIGINATION

In 1960, American technology was on the rise, and internationalism was a prominent theme. It was in this technical and global political context and this year that the planning began for a World Trade Center (WTC) to be located in lower Manhattan. From its first conception during the 1939 World's Fair in New York, it now emerged under the powerful advocacy of the Chase Manhattan Bank's David Rockefeller. Here was a grand plan that would embody the concept of New York City as a center of world commerce and provide a home for numerous international trade companies.

The organization that would build the World Trade Center was The Port of New York Authority, later to be renamed as The Port Authority of New York and New Jersey (The Port Authority, PANYNJ). Created in 1921, under a clause in the United States Constitution, to run the multijurisdictional commercial zones in the region, The Port Authority built and operated facilities on the banks of the Port of New York's waterways, the bridges to cross them, and the major metropolitan airports. It had the authority to obtain land by eminent domain and to raise funds for its projects. Now, under the leadership of its Executive Director, Austin Tobin, the concept for the World Trade Center grew from the grand plan of David Rockefeller to the grandeur of the world's largest office complex.

To fulfill all the functional, aesthetic, and economic desires for this concept, innovative architecture was needed. In 1962, the firm of Minoru Yamasaki & Associates was hired to perform the architectural design, which was first unveiled in 1964. The team also involved Emory Roth & Sons, P.C., as the architect of record.<sup>1</sup> The structural engineering was by Worthington, Skilling, Helle and Christiansen. (Some time after completion of the construction, Skilling, Helle, Christiansen, and Robertson, and then Leslie E. Robertson Associates (LERA) assumed that role.) Jaros, Baum & Bolles were hired as the mechanical engineers, and Joseph R. Loring & Associates were the electrical engineers. Tishman Construction Corporation was the general contractor.

In 1966, the formal groundbreaking for the towers took place. Construction began in 1968, with the first occupancy in 1970. These dates establish the historical context for the building codes and the state of practice under which the complex was designed and constructed. This will be discussed further in Part II.

---

<sup>1</sup> The functions of these entities are as follows. In New York City, a permit, issued by the building commissioner, is required to construct, alter, repair, demolish or remove any building. The architect who signs and generally files the plans (as part of the process for securing the permit) and takes the lead role of a project is the architect-of-record. Specific subsets of plans may be signed by the structural, electrical, and mechanical engineers, representing the separate disciplines involved in those subsets. The filed plans are reviewed and approved for compliance with the building code requirements by the building commissioner before issuance of the permit.

The City of New York had no jurisdiction. However, The Port Authority required that all the WTC tower plans be submitted for their review and approval for code compliance and other architectural requirements. The responsibility of technical correctness rested with the architect of record and the engineers of record.

The expected tenancy by companies involved in international trade did not materialize as conceived, so the State of New York, the City of New York, and The Port Authority became the principal WTC tenants in the 1970s. As the years passed, however, the prestige of the address grew, and the requirement that occupants be involved in international trade was relaxed. At the end of the twentieth century, the World Trade Center was nearly fully occupied by a diverse mixture of large and small businesses and federal, state, and city government organizations.

## **1.2 THE WORLD TRADE CENTER COMPLEX**

### **1.2.1 The Site**

By 2001, the WTC complex had become an integral part of Manhattan. It was composed of seven buildings (here referred to as WTC 1 through WTC 7) on a site toward the southwest tip of Manhattan Island (Figures 1-1 and 1-2). Whether viewed from close up, from the Statue of Liberty across the Upper Bay or from an aircraft descending to LaGuardia Airport, the towers were a sight to behold. The two towers, WTC 1 (North Tower) and WTC 2 (South Tower), were each 110 stories high, dwarfing the other skyscrapers in lower Manhattan and seemingly extending to all Manhattan the definition of “tall” previously set by midtown’s Empire State Building. WTC 3, a Marriott Hotel, was 22 stories tall, WTC 4 (South Plaza Building) and WTC 5 (North Plaza Building) were each 9-story office buildings, and WTC 6 (U.S. Customs House) was an 8-story office building. These six buildings were built around a 5-acre Plaza named in honor of Austin Tobin. WTC 7 was a 47-story office building on Port Authority land across Vesey Street on the north side of the Plaza complex. Built over the ConEd substation serving the WTC complex, it was completed in 1987 and was operated by Silverstein Properties, Inc.

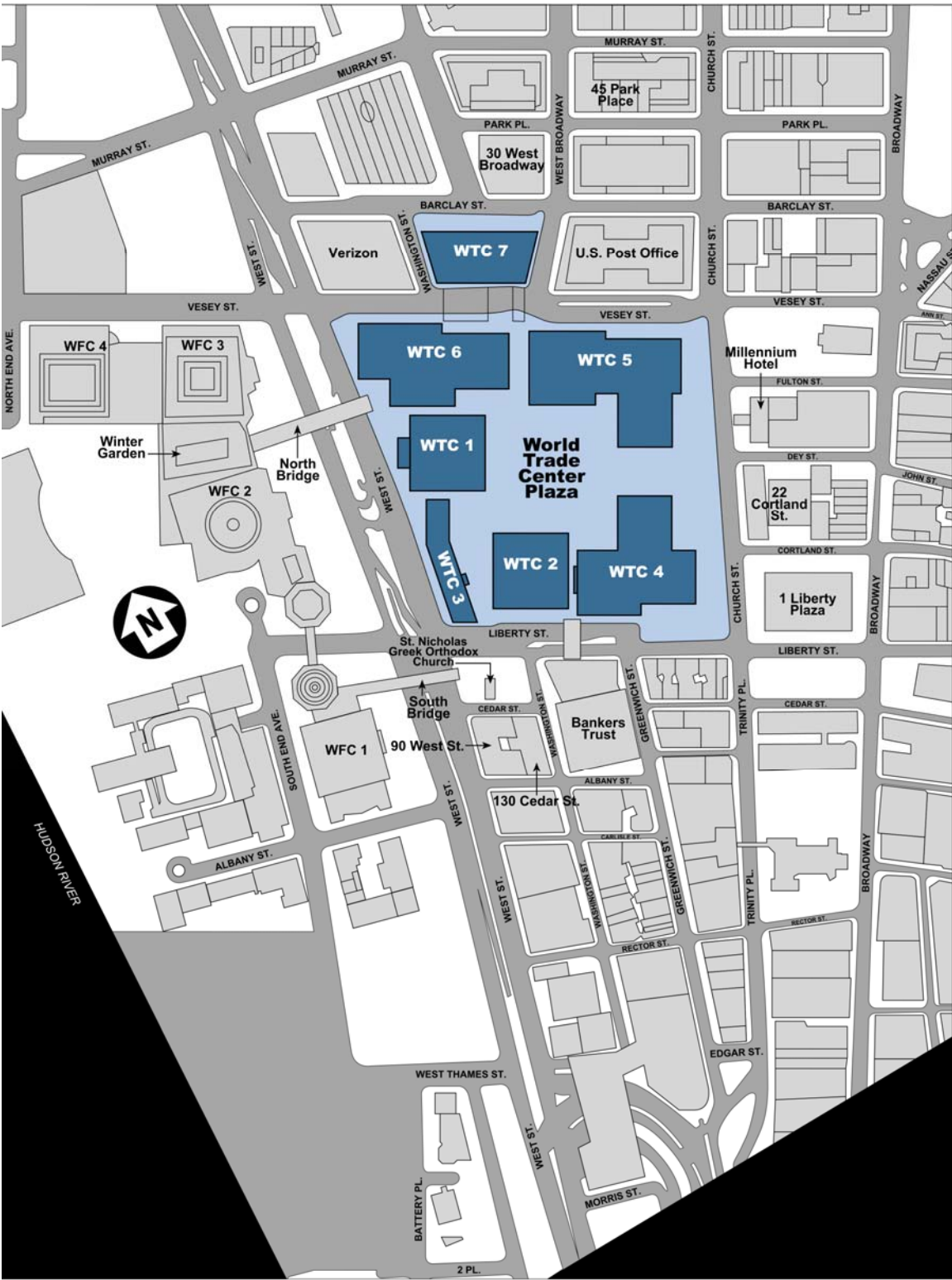

Figure 1-1. The World Trade Center in Lower Manhattan.



Source: The Imagers Team, NASA/GSFC.

**Figure 1–2. Lower Manhattan and the World Trade Center towers.**

Below the 11 western acres of the site, underneath a large portion of the Plaza and WTC 1, WTC 2, WTC 3, and WTC 6, was a 6-story underground structure. The structure was surrounded by a wall that extended from ground level down 70 ft to bedrock. Holding back the waters of the Hudson River, this wall had enabled rapid excavation for the foundation and continued to keep groundwater from flooding the underground levels.

Commuter trains brought tens of thousands of workers and visitors to Manhattan from Brooklyn and New Jersey into a new underground station below the plaza. A series of escalators and elevators took the WTC employees directly to an underground shopping mall and to the Concourse Level of the towers.

## 1.2.2 The Towers

### The Buildings

The focus of the complex was on the two towers, each taller than any other building in the world at that time. The roof of WTC 1 was 1,368 ft above the Concourse Level, 6 ft taller than WTC 2, and supported a 360 ft tall antenna mast for television and radio transmission. The footprint of each tower was a square, about 210 ft on a side (approximately an acre), with the corners of the tower beveled 9 ft 9 in. Internally, each floor was a square, about 206 ft on a side.<sup>2</sup>

The superb vistas from the top of such buildings virtually demanded public space from which to view them, and The Port Authority responded. The 107<sup>th</sup> floor of WTC 1 housed a gourmet restaurant and bar with views of the Hudson River and New Jersey to the west, the skyscrapers of midtown Manhattan to the north, the East River and Queens and Brooklyn to the east, the Statue of Liberty to the southwest, and the Atlantic Ocean to the south. Similar views could be seen from observation decks on the 107<sup>th</sup> floor and the roof of WTC 2.

Table 1–1 shows the use of the floors, which was similar but not identical in the two towers.

**Table 1–1. Use of floors in the WTC towers.**

Floor(s)	WTC 1	WTC 2
Roof	Antenna space and window washing equipment	Outdoor observation deck and window washing equipment
110	Television studios	Mechanical equipment
108, 109	Mechanical equipment	Mechanical equipment
107	Windows on the World restaurant	Indoor observation deck
106	Catering	Tenant space
79 through 105	Tenant space	Tenant space
78	Skylobby, tenant space	Skylobby, tenant space
77	Tenant space	Tenant space
75, 76	Mechanical equipment	Mechanical equipment
45 through 74	Tenant space	Tenant space
44	Skylobby, cafeteria, tenant space	Skylobby, tenant space
43	Port Authority space	Tenant space
41, 42	Mechanical equipment	Mechanical equipment
9 through 40	Tenant space	Tenant space
7, 8	Mechanical floors	Mechanical floors
Concourse through 6	6-story lobby	6-story lobby

<sup>2</sup> Extensive details regarding all aspects of this report are found in the supporting Investigation reports listed in Appendix B. A subject index of those reports appears as Appendix C to this report. Those reports, in turn, cite the numerous documents made available to the Investigation Team. To maintain continuity, citations of the source documents are not included in this report. They are found in the supporting Investigation reports.

The Port Authority had managed the operation of the two towers since their opening three decades earlier. Silverstein Properties acquired a 99-year lease on the towers in July 2001.

## The Structures

Each of the tenant floors of the towers was intended to offer a large expanse of workspace, virtually uninterrupted by columns or walls. This called for an innovative structural design, lightweight to minimize the total mass of 110 stories, yet strong enough to support the huge building with all its furnishings and people. Structural engineers refer to the building weight as the *dead load*; the people and furnishings are called the *live load*. Collectively, these are referred to as *gravity loads*. The buildings would also need to resist *lateral loads* and excessive swaying, principally from the hurricane force winds that periodically strike the eastern seaboard of the United States. An additional load, stated by The Port Authority to have been considered in the design of the towers, was the impact of a Boeing 707, the largest commercial airliner when the towers were designed, hitting the building at its full speed of 600 mph.

In 1945, a B-25 aircraft had become lost in the fog and struck the 78<sup>th</sup> and 79<sup>th</sup> floors of the Empire State Building. The building withstood the impact and ensuing fire and was ready for reoccupancy the following week.

Skilling and his team rose to the challenge of providing the required load capacity within Yamasaki's design concept. They incorporated an innovative framed-tube concept for the structural system. The columns supporting the building were located both along the external faces and within the core. The core also contained the elevators, stairwells, and utility shafts. The dense array of columns along the building perimeter was to resist the lateral load due to hurricane-force winds, while also sharing the gravity loads about equally with the core columns. The floor system was to provide stiffness and stability to the framed-tube system in addition to supporting the floor loads. Extensive and detailed studies were conducted in wind tunnels, instead of relying on specific, prescriptive building code requirements, to estimate the wind loads used in the design of these buildings.<sup>3</sup> This approach took advantage of the allowance by most state and local building codes for alternative designs and construction if evidence were presented that ensured equivalent performance.

A grade of steel is characterized by its yield strength, expressed in ksi, or thousands of pounds per square inch. This is the force per unit area at which the steel begins to undergo a permanent deformation. Different steel strengths, or grades, are manufactured by varying the chemistry and processing of the alloy. Higher strength steel is used when the design calls for more strength per weight of the steel column or beam.

There were four major structural subsystems in the towers, referred to as the exterior wall, the core, the floor system, and the hat truss. The first, the exterior structural subsystem, was a vertical square tube that consisted of 236 narrow columns, 59 on each face from the 10<sup>th</sup> floor to the 107<sup>th</sup> floor (Figure 1–3). There were also columns on alternate stories at each of the beveled corners, but these carried none of the gravity loads. (There were fewer, wider-spaced columns below the 7<sup>th</sup> floor to accommodate doorways.) Each column was fabricated by welding four steel plates to form a tall box, nominally 14 in. on a side. The space between the steel columns was 26 in., with a narrower,

<sup>3</sup> The studies showed that each tower affected the wind loads on the other. This effect was not accounted for in the prescriptive wind load requirements found in building regulations.



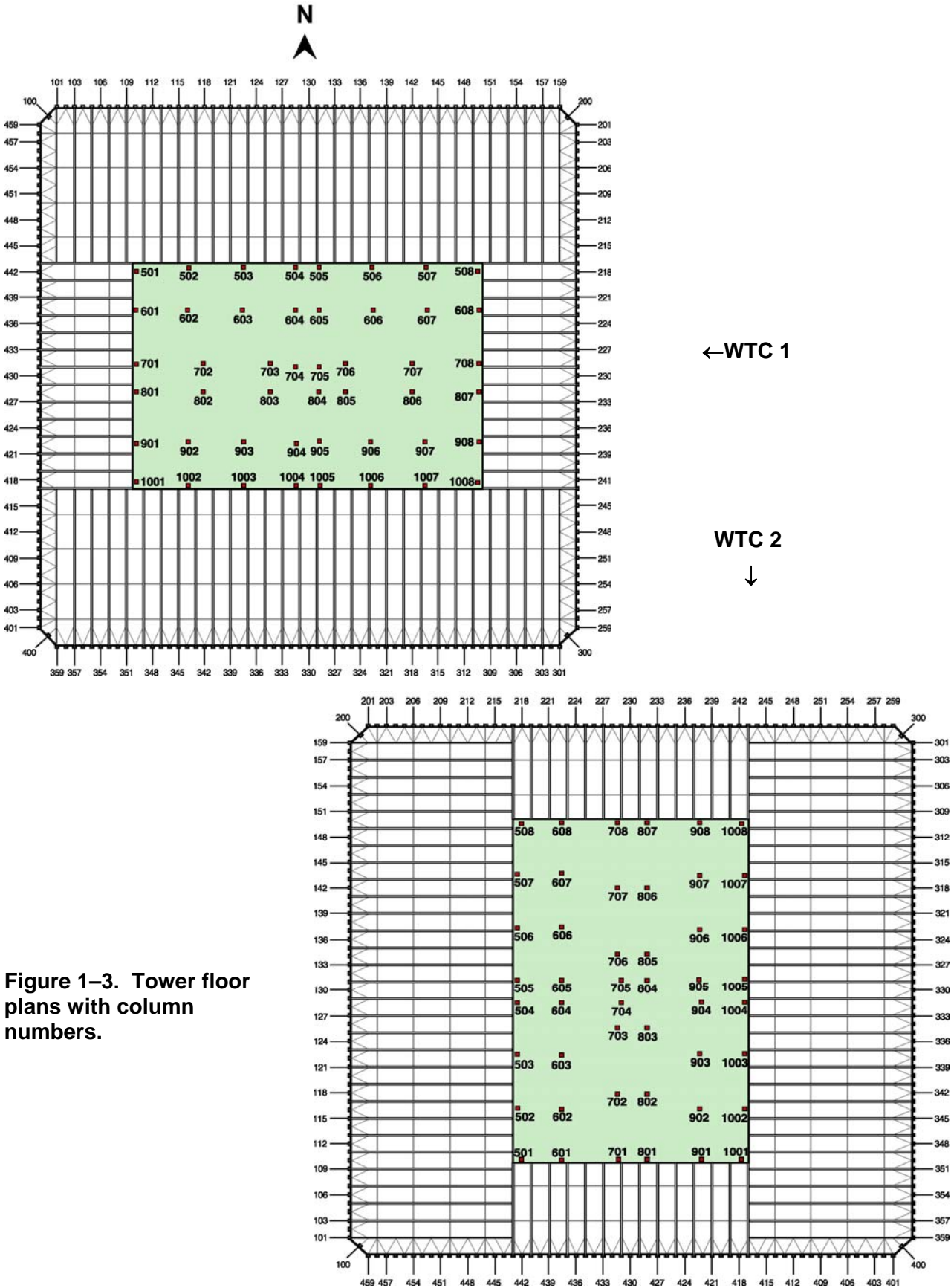
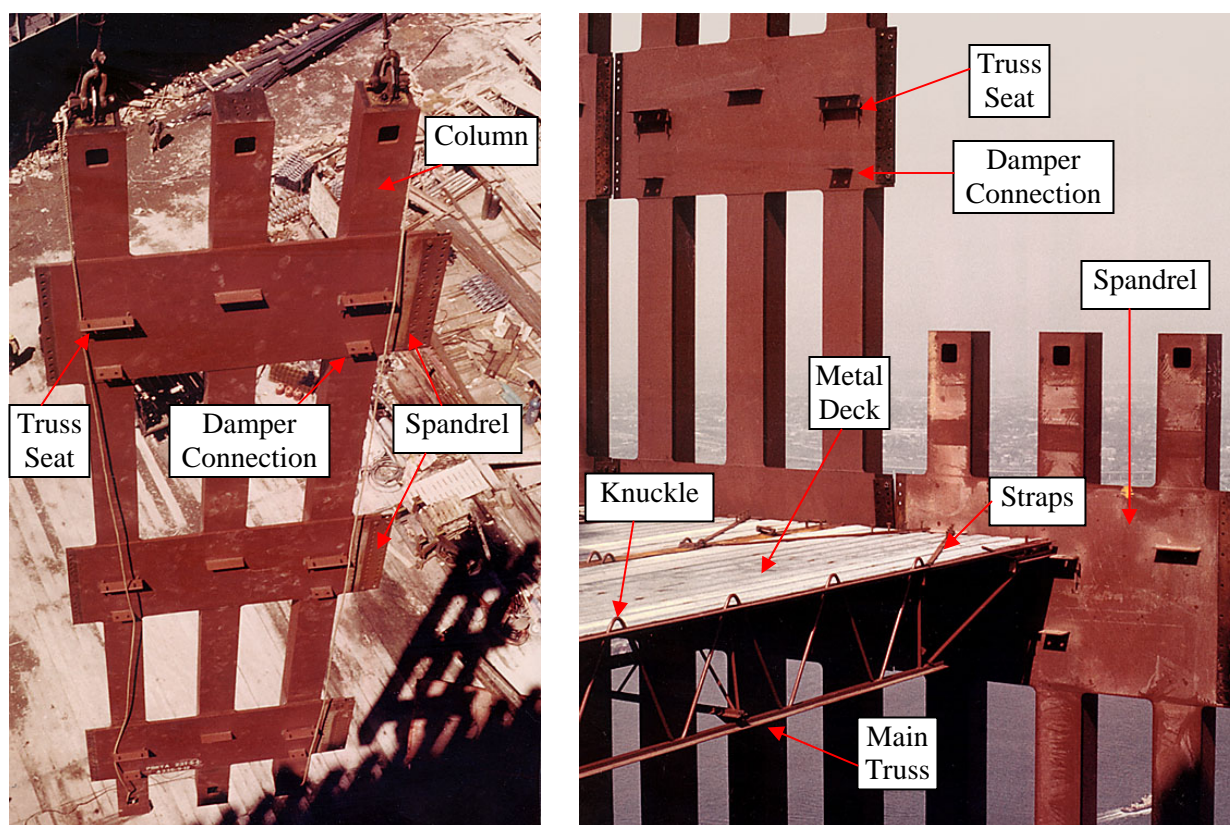

Figure 1-3. Tower floor plans with column numbers.

framed plate glass window in each gap. Adjacent columns were connected at each floor by steel spandrel plates, 52 in. high. The upper parts of the buildings had less wind load and building mass to support. Thus, on higher floors, the thickness of the steel plates making up the columns decreased, becoming as thin as ¼ in. near the top. There were 10 grades of steel used for the columns and spandrels, with yield strengths ranging from 36 ksi to 100 ksi. The grade of steel used in each location was dictated by the calculated stresses due to the gravity and wind loads.

All the exterior columns and spandrels were prefabricated into welded panels, three stories tall and three columns wide. The panels, each numbered to identify its location in the tower, were then bolted to adjacent units to form the walls (Figure 1–4). The use of identically shaped prefabricated elements was itself an innovation that enabled rapid construction. The high degree of modularization and prefabrication used in the construction of these buildings and the identification, tracking, and logistics necessary to ensure that each piece was positioned correctly was unprecedented.



Source: Unknown. Enhanced by NIST.

**Figure 1–4. Perimeter column/spandrel assembly and floor structure.**

A second structural subsystem was located in a central service area, or core (Figure 1–5), approximately 135 ft by 87 ft, that extended virtually the full height of the building. The long axis of the core in WTC 1 was oriented in the east-west direction, while the long axis of the core in WTC 2 was oriented in the north-south direction (Figure 1–3). The 47 columns in this rectangular space were fabricated using primarily 36 ksi and 42 ksi steels and also decreased in size at the higher stories. The four massive corner columns bore nearly one-fifth of the total gravity load on the core columns. The core columns were interconnected by a grid of conventional steel beams to support the core floors.

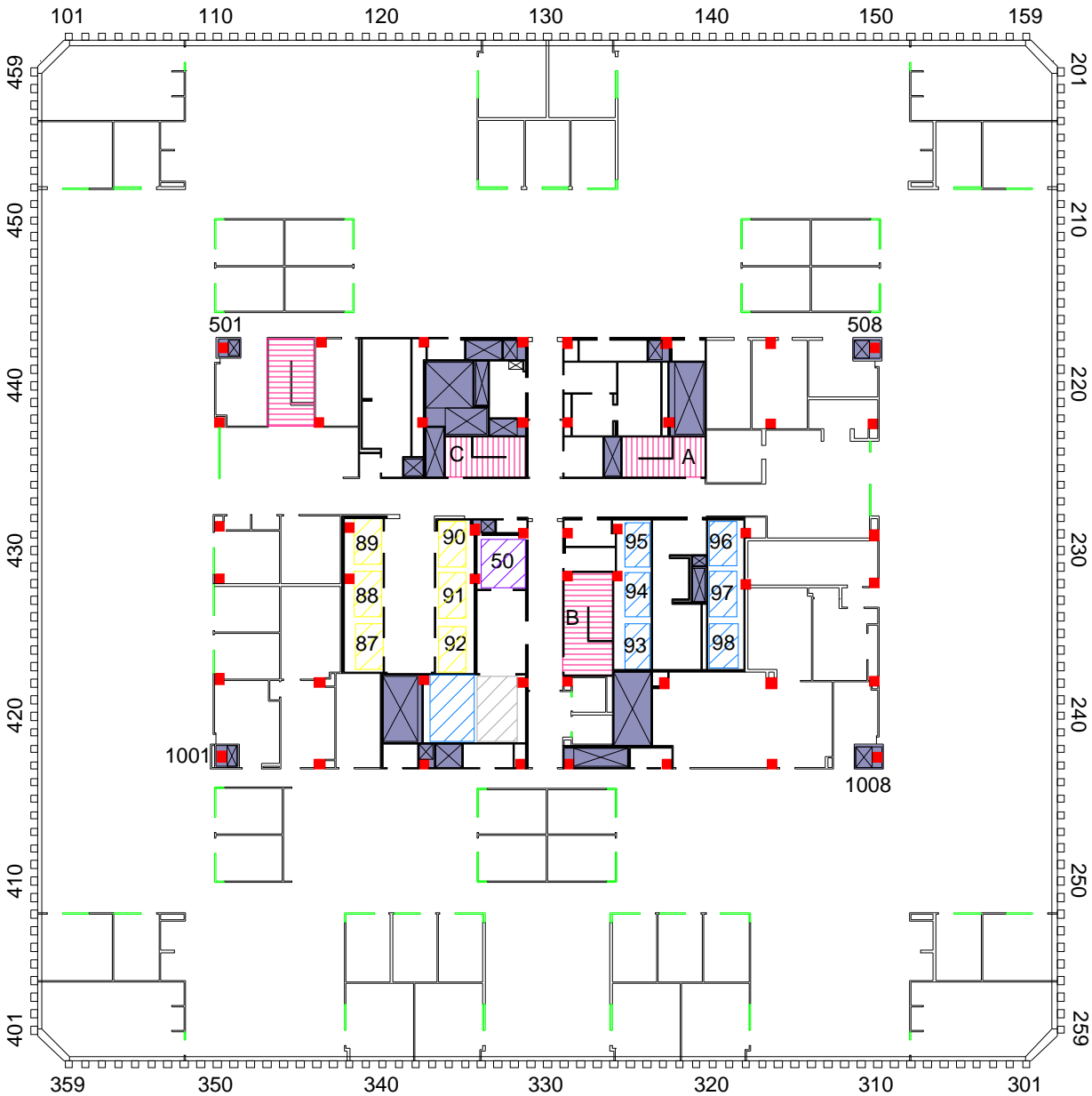

WTC1 96

**Note:** Column numbers are shown around the perimeter. The four corner core columns (501, 508, 1001, and 1008) are marked for orientation. Stairwells A, B, and C are shown in red stripes. The fourth red-striped area is the tenant's convenience stairwell that connected the 95<sup>th</sup> through 97<sup>th</sup> floors in WTC 1; it was not considered part of the egress system. The remaining numbers denote specific elevators. Much of the rest of the floor was open space suited for offices, conference rooms, or office cubicles. The arrangement and size of the core varied among the different floors.

**Figure 1-5. Plan of the 96<sup>th</sup> floor of WTC 1 showing the core and tenant spaces.**

The third major structural subsystem was the floors in the tenant spaces. These floors supported their own weight, along with live loads, provided lateral stability to the exterior walls, and distributed wind loads among the exterior walls. The floor construction was an innovation for a tall building. As shown in Figure 1–6, each tenant floor consisted of 4 in. thick, lightweight cast-in-place concrete on a fluted steel deck, but that is where “ordinary” ended. Supporting the slab was a grid of lightweight steel bar trusses. The top bends (or “knuckles”) of the main truss webs extended 3 in. above the top chord and were embedded into the concrete floor slab. This concrete and steel assembly thus functioned as a composite unit, that is, the concrete slab acted integrally with the steel trusses to carry floor loads. The primary truss pairs were either 60 ft or 35 ft long and were spaced at 6 ft 8 in. There were perpendicular bridging trusses every 13 ft 4 in. The floor trusses and fluted metal deck were prefabricated in panels that were typically 20 ft wide and that were hoisted into position in a fashion similar to the exterior wall panels.

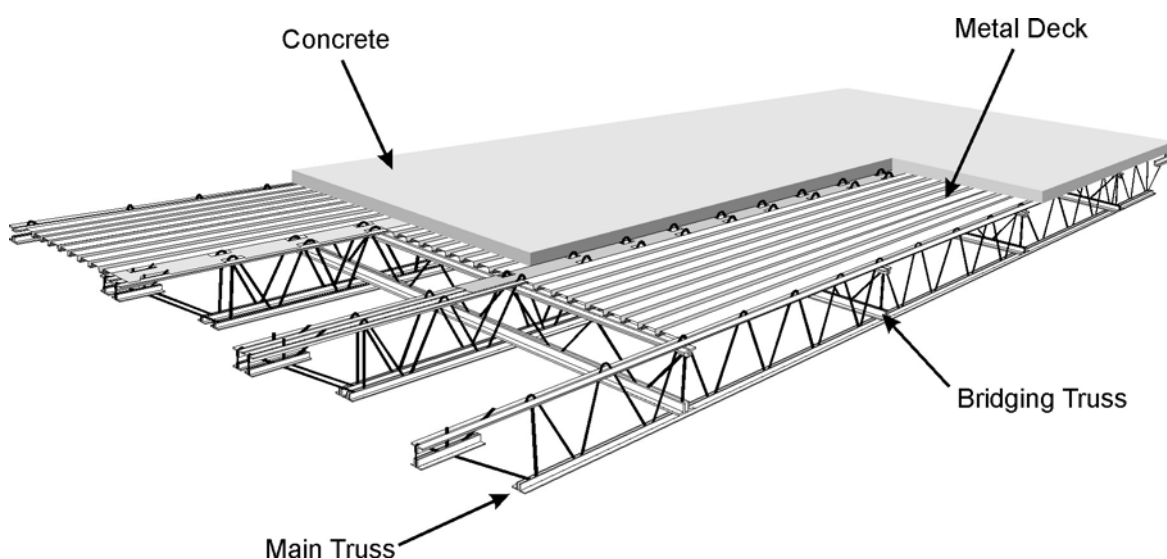

**Figure 1–6. Schematic of composite floor truss system.**

The bottom chords were connected to the spandrel plates by devices that were called viscoelastic dampers. Experiments on motion perception, conducted with human subjects, had shown a high potential for occupant discomfort when the building swayed in a strong wind. When the tower was buffeted by strong winds, these dampers absorbed energy, reducing the sway and the vibration expected from a building that tall. The use of such vibration damping devices in buildings was an innovation at that time.

The fourth major structural subsystem was located from the 107<sup>th</sup> floor to the roof of each tower. It was a set of steel braces, collectively referred to as the “hat truss” (Figure 1–7). Its primary purpose had been to support a tall antenna atop each tower, although only WTC 1 had one installed. The hat truss provided additional connections among the core columns and between the core and perimeter columns, providing additional means for load redistribution.

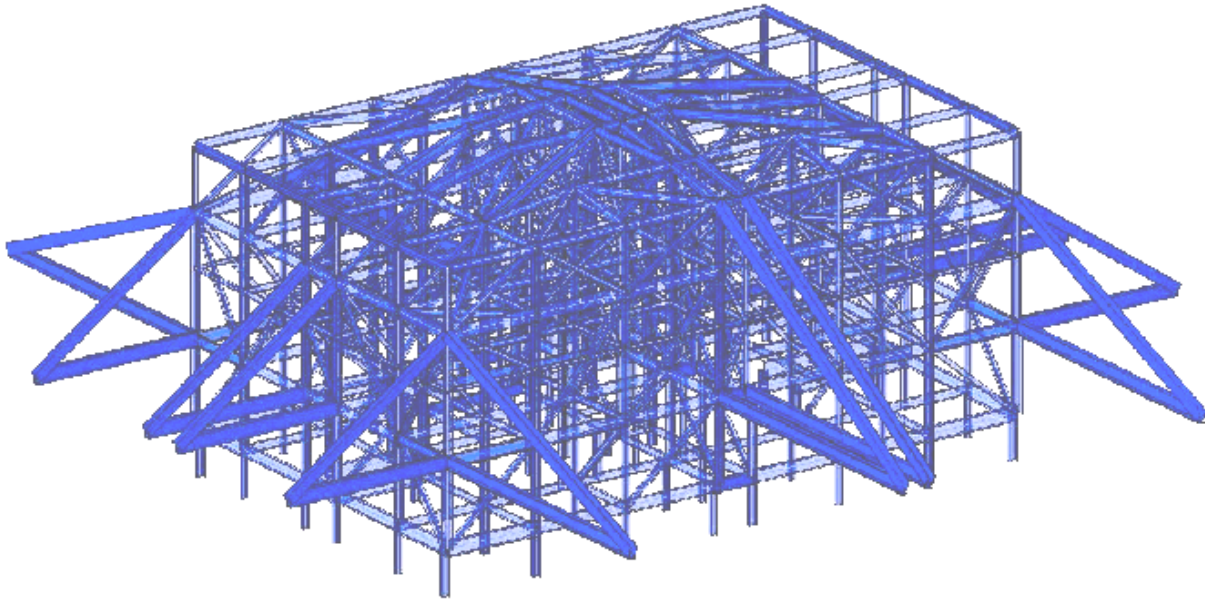

**Figure 1–7. Schematic of a hat truss.**

## **Fire Resistance**

High-rise buildings in the United States are designed to meet requirements intended, among other objectives, to enable the building to suffer a sizable fire and still remain standing. The requirements are expressed in terms of fire resistance ratings, given in units of time.

The fire resistance of a column, wall, or floor design is rated by subjecting the assembly to standard heating conditions. A sample section of a wall to be tested is installed as one face of a furnace; a floor becomes the top of the furnace. Beams are normally rated as a part of the floor test. Floor systems are always tested while carrying their full design load. Walls are similarly loaded if they are intended to be load bearing, but are not loaded if the only load they are intended to support is their own weight. In the United States, columns are required to be loaded during the test, however, an alternative is often used, whereby the columns is not loaded and the temperature of the steel is used as a limiting criterion.

It is widely recognized in the building profession that fire resistance ratings, although expressed in hours, do not mean that the structure will sustain its performance for that length of time in a real fire. Actual fire performance may be greater or less than that achieved in the test furnace, depending on the severity of the actual fire exposure. Rather, these are taken as relative ratings, e.g., a wall rated at 2 hours will block the spread of a fire longer than a wall rated at 1 hour.

## **Fire Protection Systems**

Bare structural steel components, when exposed to a large and sustained fire, can heat rapidly to the point where their ability to support their load is compromised. Thus, insulation is usually employed to encapsulate the steel and thus delay the heating of the steel. In the WTC towers, a major fraction of the core columns were enclosed or protected on several sides by sheets of gypsum wallboard. The trusses, perimeter columns, spandrels, and one or more surfaces of the core columns were coated with one of

three different sprayed fire-resistive material (SFRM). In this report, these materials are collectively referred to as “insulation.”<sup>4</sup> The thickness of the wallboard or the SFRM was selected to provide an intended level of thermal protection. Figure 1–8 shows the appearance of a floor truss with sprayed insulation.



**Figure 1–8. Photograph of insulated WTC trusses.**

Further protection of the building against a fire was provided in part by internal, nonstructural, fire-rated walls. These floor-slab-to-floor-slab partitions, called demising walls, separated the tenant spaces from each other and from the core area. Their function was to keep a fire from spreading long enough for the fire to be extinguished. In a 1975 fire in WTC 1, these walls significantly confined the fire.

There were three types of nonstructural walls in the towers. The stairwells and elevator shafts were surrounded by 2 in. thick, tongue-and-groove, cast gypsum panels, covered with two or three sheets of 5/8 in. gypsum board. The demising walls were made of two sheets of 5/8 in. thick gypsum wallboard on each side of steel studs. These are often regarded as providing a 2 hour fire separation. Walls in the interior of the tenant spaces generally extended from the floor slab to the bottom of the drop ceiling and were made of single sheets of 5/8 in. gypsum wallboard over steel studs. These walls were not fire-rated. For some conference rooms and other spaces where sound barriers were desired, the walls extended to bottom of the floor slab above, in which case they were regarded as providing a 1 hour fire separation.

In addition to these methods of passive fire protection, there were components that would be activated in the event of a fire. Automatic fire sprinklers had been installed in all of the office spaces. NIST

---

<sup>4</sup> The materials used to insulate structural steel are sometimes colloquially referred to as "fireproofing," referring to the intent of the material, rather than the property it imparts. Since an important facet of this Investigation was the determination of the sufficiency of the insulation in protecting the steel from the heat of the fires, this report does not pre-judge the quality of the material by using the colloquial term.

calculations showed that the installed automatic sprinkler system was capable of delivering the minimum required water flow for control of office fires up to 4,500 ft<sup>2</sup>. This was a small fraction of the 40,000 ft<sup>2</sup> size floors in the towers. In addition, in the stairwells, there were standpipes (for firefighters to connect their hoses) that were supplied with water by gravity feed from 5,000 gal tanks and by large fire pumps. A multifunction fire alarm system was intended to alert staff at the Fire Command Station within the building and provide voice and strobe alerts throughout. When turned on after the building had been cleared of people, a smoke purge system was intended to purge the hot, opaque fire gases from the building.

However, buildings were not (and still are not) required by the building codes or designed to withstand the impact of a fuel-laden jetliner. Although the impact of a Boeing 707 was stated by the Port Authority to have been considered in the original design of the towers, only one three-page document, in a format typically used for talking points was found that addressed the issue. This document stated that such a collision would result in only local damage and could not cause collapse or substantial damage to the building. NIST was unable to locate any evidence to indicate consideration of the extent of impact-induced structural damage or the size of a fire that could be created by thousands of gallons of jet fuel.

## The Workplace

At the beginning of the workday, many of the roughly 40,000 people who worked in the towers and visited to conduct business or to tour emerged from trains in the massive subterranean station. They would take escalators and elevators to a one-story shopping mall, then pass through revolving doors to enter a spacious, 6-story-high lobby on the Concourse Level. There, they would cross paths with those who arrived on foot or by bus or cab.

Getting tens of thousands of people from the Concourse to their offices was no small task. This was accomplished by a combination of express and local elevators located within each of the building cores (Figure 1–9) that was novel at the time of construction.

- People traveling to floors 9 through 40 entered a bank of 24 local elevators at the Concourse Level. These were divided into four groups, with each stopping at a different set of eight or nine floors (9 through 16, 17 through 24, 25 through 31, and 32 through 40).
- Those going to floors 44 through 74 took one of eight express elevators to the 44<sup>th</sup> floor skylobby before transferring to one of 24 local elevators. These 24 were stacked on top of the lower bank of 24, providing additional transport without increasing the floor space occupied by the elevators.
- Those going to floors 78 through 107 took one of 11 express elevators from the Concourse Level to the 78<sup>th</sup> floor skylobby before transferring to one of 24 local elevators. These were also stacked on the lower banks of 24 local elevators.

While providing the desired high rate of people movement, this three-tier system used roughly 25 percent less of the building footprint than the conventional systems in which all elevators would have run from the Concourse to the top of the building, resulting in a building core that took up as much as one-half of the floor area. In addition, there was even more rentable space to be gained. At the top of each elevator bank, the machinery to lift the cabs occupied one additional floor. From the next floor up to the bottom of

the next bank, there was no need for an elevator shaft. The concrete floor was extended into this space, providing additional rentable floor area.

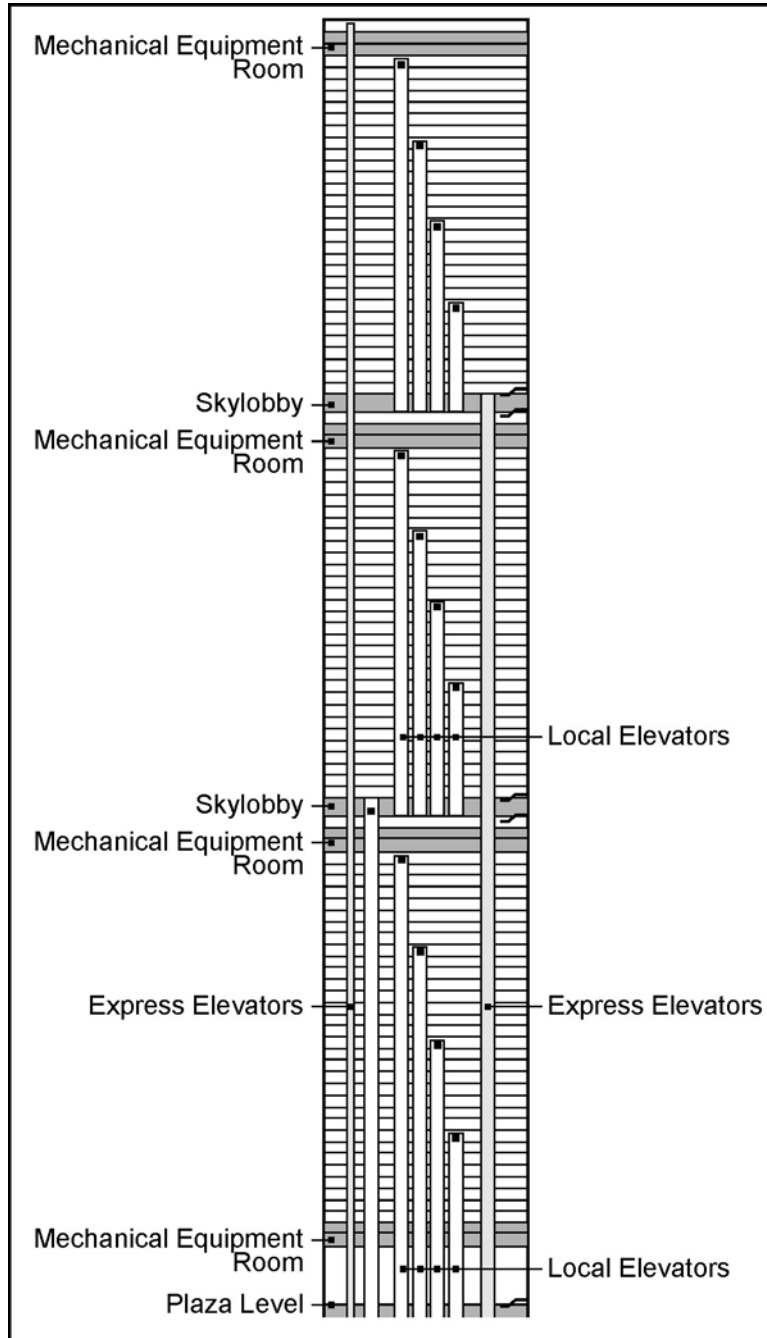

**Figure 1–9. Schematic of the three-tier elevator system.**

There were two additional express elevators to the Windows on the World restaurant (and related conference rooms and banquet facilities) in WTC 1 and to the observation deck in WTC 2. There were also five local elevators: three that brought people from the subterranean levels to the lobby, one that ran between floors 106 and 110, and one that ran between floors 43 and 44 (in WTC 1), serving the cafeteria



from the skylobby. There were also eight freight elevators, one of which served all floors. All elevators had been upgraded to incorporate firefighter emergency operation requirements.

Also within the core were three sets of stairs that extended nearly the full height of the tower (Figure 1–10). However, the stairwell at an upper floor did not continuously descend to the lobby, but rather to horizontal corridors in the vicinity of the mechanical floors. These enclosed corridors ranged in length from about 10 ft to about 100 ft. (As a result of these and the tiered elevator system, the core arrangements varied substantially from floor to floor.) After traversing each of these, the pedestrians would resume their descent, eventually reaching the tower lobby, from which they could exit the building. The advantages of moving stairwell locations included reclaiming core space for occupant use above terminated elevator shafts and overcoming obstructions posed by equipment installed on mechanical floors.

Following the February 26, 1993, bombing of WTC 1 and in light of the 4 hours needed to evacuate the building, several improvements had been made to the stairwells: battery operated emergency lighting, photoluminescent floor strips indicating the path to be followed, and explicit signs on each doorway to indicate where it led.

Upon exiting the elevators or stairs, the interior view was typical of high-rise buildings. Surrounding the rectangular core corridor was a mixture of walls, entry doors to firms, and glass-front reception areas. Above was a drop ceiling.

Many of the floors were occupied by a single tenant. Some of these tenants occupied multiple floors. By 2001, most of these companies had moved in after the installation of automatic sprinklers, which had allowed the absence of internal partitions. These companies largely took advantage of Yamasaki's design concept of a vast space that was nearly free of obstructions. The open arrangement often included as many as 200 or more individual modular workstations or office cubicles, generally clustered in groups of six or eight (Figure 1–11). Trading floors had arrays of tables with multiple computer screens (e.g., Figure 1–12, of a trading floor in WTC 4). Some of these floors had a few executive offices in the corners and along the perimeter. Many also had walled conference rooms. It was common for the tenants occupying multiple floors to create openings in the floor slabs and install convenience stairs between their floors.

Some floors were subdivided to accommodate as many as 20 firms. Some of the smaller firms occupied space in the core area in the spaces over the elevator shafts.

With thousands of workers and visitors in the buildings, there needed to be food service. The Port Authority maintained a cafeteria on the 43<sup>rd</sup> floor of WTC 1. In addition, a number of the companies maintained kitchen areas on their floors, where catered food was brought in daily, making it unnecessary for their staff to leave the building for lunch. There was a public cafeteria on the 44<sup>th</sup> floor of WTC 1. The visiting public could eat at Windows on the World at the top of WTC 1, at several restaurants on the observation deck of WTC 2, or in the many eateries on the Concourse Level. There were hundreds of restrooms, in both the tenant and the core spaces.

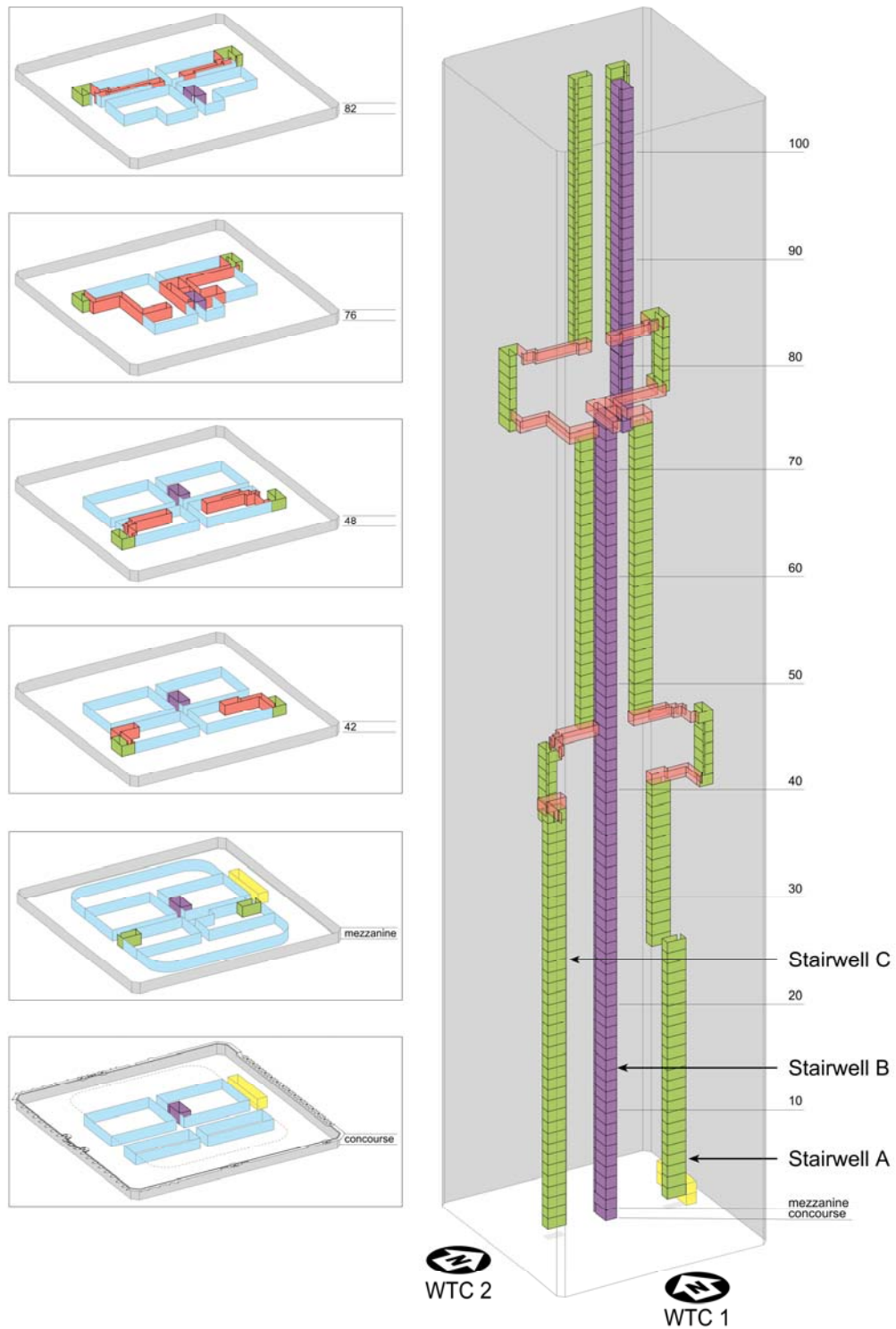

Figure 1-10. Orientation of the three stairwells.



**Figure 1–11. Views of typical WTC office floors.**

**Source:** Reproduced with permission of The Port Authority of New York and New Jersey.



**Figure 1–12. A WTC trading floor.**

**Source:** Reproduced with permission of The Port Authority of New York and New Jersey.

This page intentionally left blank.

## Chapter 2

# THE ACCOUNT OF WORLD TRADE CENTER 1

---

### 2.1 8:46:30 A.M. EDT

On the morning of Tuesday, September 11, 2001, a lot of people were going to be late for work in New York City, which for many started at 9:00 a.m. or later. It was the first day of school for many local children, and it also was a primary election day in New York. The weather was clear and comfortable with little wind to speak of, so some took time to do early morning errands. As a result, only about 8,900 of the typical 20,000 people were in World Trade Center (WTC) 1 shortly before 9:00 a.m.

At 8:46:30 a.m. EDT, five hijackers flew American Airlines Flight 11 (AA 11) with 11 crew and 76 passengers into the north face of WTC 1 (Figure 2–1).

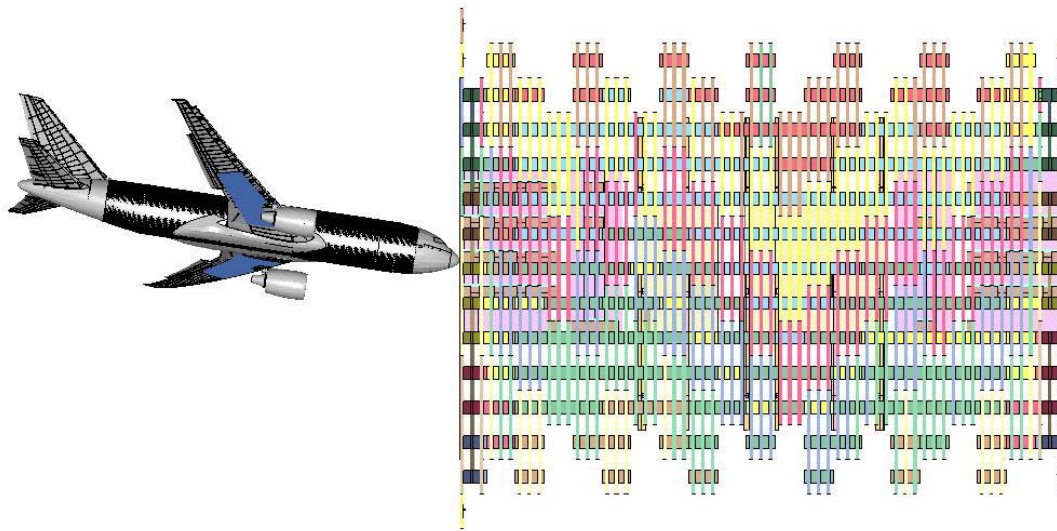

**Figure 2–1. Simulated impact of American Airlines Flight 11 with WTC 1.**

What follows is the result of an extensive, state-of-the-art reconstruction of the events that accompanied and followed the aircraft impact. Numerous facts and data were obtained, then combined with validated computer modeling to produce an account that is believed to be close to what actually occurred. However, the reader should keep in mind that the building and the records kept within it were destroyed, and the remains of the towers were disposed of before congressional action and funding was available for this Investigation to begin. As a result, there are some facts that could not be discerned, and thus there are uncertainties in this accounting. Nonetheless, the National Institute of Standards and Technology (NIST) was able to gather sufficient evidence and documentation to conduct a full investigation upon which to reach firm findings and recommendations. The reconstruction effort, the uncertainties, the assumptions made, and the testing of these assumptions are documented in Part II of this report.

## 2.2 THE AIRCRAFT

The Boeing 767-200ER was a twin-engine, wide-body aircraft, 159 ft 2 in. long, with a wingspan of 156 ft 1 in. Empty, it weighed 183,500 lb. It could carry 181 passengers in its three-class seating configuration and 23,980 gal (158,200 lb) of jet fuel as it covered its maximum cruising range of 6,600 miles. The maximum total weight the plane could carry was specified at 395,000 lb; the typical cruising speed was 530 mph.

The 767-200ER aircraft had two fuel tanks that extended through most of the interior of the wings and a center tank between the wings in the bottom of the fuselage. A full fuel load would have filled all three tanks.

On that day, AA Flight 11 was much lighter. Bound from Boston for Los Angeles, some 3,000 miles away, it carried only about half the full load of jet fuel. When it hit the north tower, it likely contained about 10,000 gal (66,000 lb), evenly distributed between the right and left wing tanks. Because of the tight maneuvers as the plane approached the tower, the baffles in both tanks had directed the fuel toward the inboard side of each wing. The passenger cabin was more than half empty. The cargo bay, carrying less than a full load of luggage, contained 5 tons of luggage, mail, electronic equipment, and food. The total weight of the aircraft was estimated to be 283,600 lb.

## 2.3 THE IMMEDIATE DAMAGE

The aircraft flew almost straight toward the north tower, banked approximately 25 degrees to the left (i.e., the right wing elevated relative to the left wing) and descended at an angle of about 10 degrees at impact. Moving at about 440 mph, the nose hit the exterior of the tower at the 96<sup>th</sup> floor. The aircraft cut a gash that was over half the width of the building and extended from the 93<sup>rd</sup> floor to the 99<sup>th</sup> floor (Figures 2–2 and 2–3). All but the lowest of these floors were occupied by Marsh & McLennan, a worldwide insurance company, which also occupied the 100<sup>th</sup> floor. Marsh & McLennan shared the 93<sup>rd</sup> floor with Fred Alger Management, an investment portfolio management company.

There was relatively little impact damage to the 93<sup>rd</sup> floor, hit only by the outboard 10 ft of the left wing. Containing no jet fuel, the wing tip was shredded by the perimeter columns. The light debris did minimal damage to the columns or to the thermal insulation on the trusses of the composite floor system supporting the 94<sup>th</sup> floor.<sup>5</sup> The trusses supporting the 94<sup>th</sup> floor were impacted by flying debris on the 93<sup>rd</sup> floor.

The 94<sup>th</sup> floor was more severely damaged. The midsection of the left wing, laden with jet fuel, and the left engine cut through the building façade, severing 17 of the perimeter columns and heavily damaging four more. The pieces of the aircraft continued inward, severing and heavily damaging core columns. The insulation applied to the floor trusses above and the columns was scraped off by shrapnel-like aircraft debris and building wall fragments over a wedge almost 100 ft wide at the north face of the tower and 50 ft wide at the south end of the building core.

---

<sup>5</sup> The reader should bear in mind that the described damage to the building exterior was derived from eyewitness and photographic evidence. The described damage to the aircraft and the building interior was deemed most likely from the computer simulations and analysis carried out under the Investigation.



**Figure 2–2. Aircraft entry hole on the north side of WTC 1, photographed 30 s after impact.**

The aircraft did the most damage to the 95<sup>th</sup> and 96<sup>th</sup> floors. The fuel-heavy inner left wing hit the 95<sup>th</sup> floor slab, breaking it over the full 60 ft depth of tenant space and another 20 ft into the building core. The fuselage was centered on the 96<sup>th</sup> floor slab and filled the 95<sup>th</sup> and 96<sup>th</sup> floors top to bottom. The severity of the impact was clear. A wheel from the left wing landing gear flew through multiple partitions, through the core of the building, and became embedded in one of the exterior column panels on the south side of the tower. The impact severed the bolts connecting the panel to its neighbors, and the panel and tire landed on Cedar Street, some 700 ft to the south. A second wheel landed 700 ft further south. Within the two floors, 15 to 18 perimeter columns and five to six core columns were severed, and an additional one to three core columns were heavily damaged. A 40 ft width of the 96<sup>th</sup> floor slab was broken 80 ft into the building. The insulation was knocked off nearly all the core columns and over a 40 ft width of floor trusses from the south end of the core to the south face of the tower.

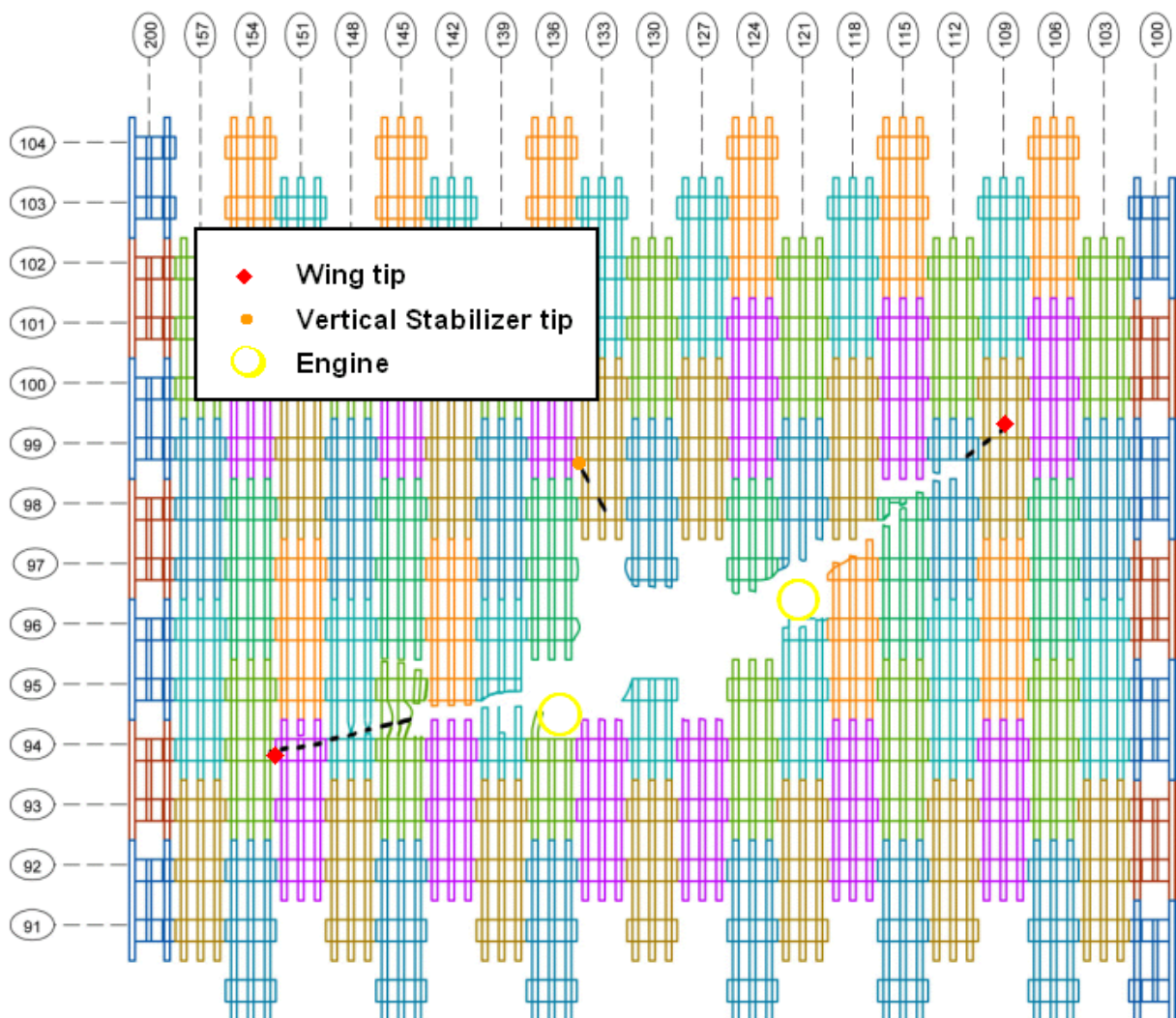

**Figure 2–3. South face damage of WTC 1 with key aircraft component locations marked.**

The right wing of the aircraft was fragmented by the perimeter columns on the 97<sup>th</sup> floor. In the process, 12 of those columns were severed. The debris cut a path through the west and center array of trusses and core columns, stripping the insulation over a 90 ft wide path. The insulation was stripped from a 50 ft wide path on the south side of the floor space.

On the 98<sup>th</sup> and 99<sup>th</sup> floors, the outboard 30 ft of the starboard wing was sliced by the perimeter columns, of which five were severed. The debris cut a shallow path through the west and center array of trusses, damaging the insulation up to the north wall of the building core.

This devastation took 0.7 s. The structural and insulation damage was considerable (Figure 2–4) and was estimated to be:

- 35 exterior columns severed, 2 heavily damaged.
- 6 core columns severed, 3 heavily damaged.



- 43 of 47 core columns stripped of insulation on one or more floors.
- Insulation stripped from trusses covering 60,000 ft<sup>2</sup> of floor area.

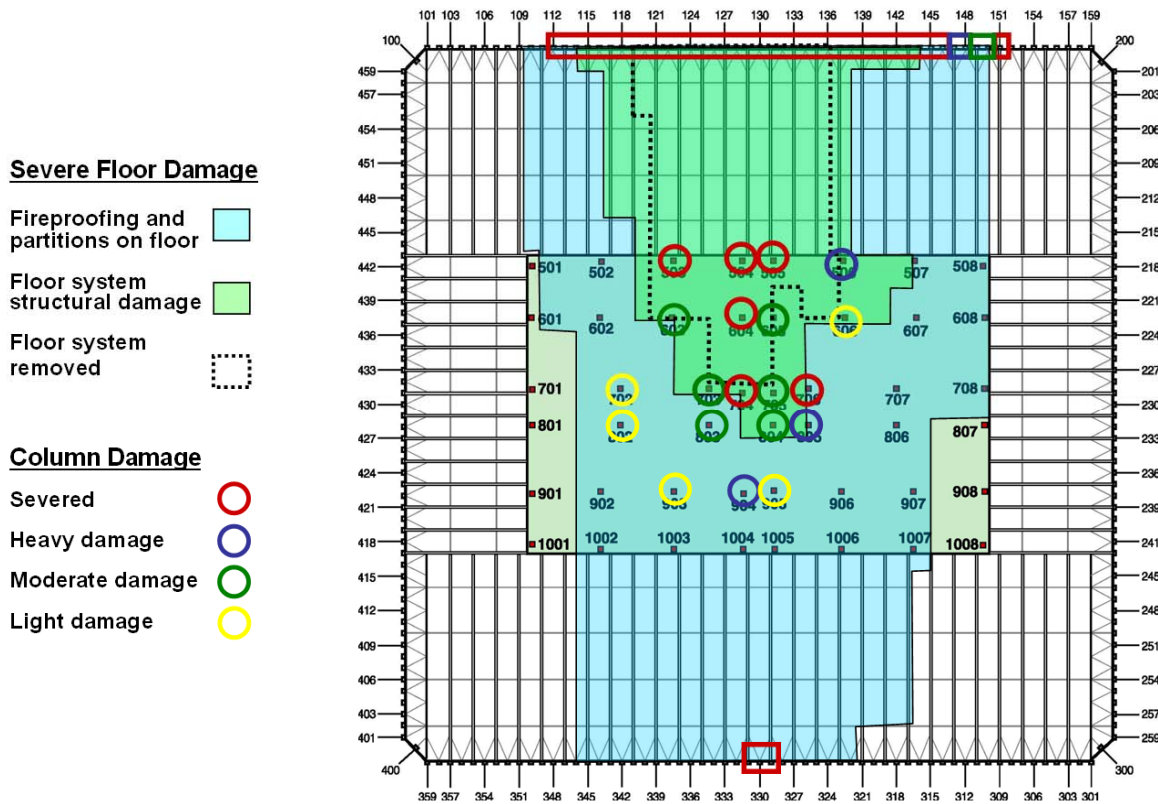

**Figure 2-4. Simulation of cumulative aircraft impact damage to floors 93 through 98 in WTC 1.**

*Even with all this damage, the building still stood.* The acceleration from the impact had been so severe that people even on lower floors were knocked down and furniture was thrown about. Some survivors reported fallen ceiling tiles throughout the building, all the way down to the Concourse Level. The pipes that fed the automatic fire sprinkler system were severed. At least 166 windows were broken. Damage to interior walls was reported from the Lobby to the 92<sup>nd</sup> floors. However, the building was designed with reserve capacity: it could support significantly more load than the weight of the structure and its people and contents. The building redistributed the load from the severed perimeter columns, mainly to their neighboring columns. The undamaged core columns assumed the remaining load, as well as the load from their damaged neighbors. WTC 1 still stood, and would have continued to do so, if not for the fires that followed.

NIST could not determine how many occupants were in the path of the aircraft as it entered the tower. Those in the direct collision path were almost certainly killed instantly. Many more would have lost their lives from the burst of heat from the burning jet fuel. Fatal injuries were reported on floors as low as the Concourse Level, where a fireball swept through the lobby.

In the impact region was further damage that would cost the lives of all the 1,355 people from the 92<sup>nd</sup> floor to the 110<sup>th</sup> floor. The crash and flying debris had collapsed the walls of all three stairwells and interrupted all elevator service to the upper 60 floors. All opportunity for escape had been eliminated.

## **2.4 THE JET FUEL**

To the wings of the 767-200ER, the perimeter columns acted like knife blades, slashing the aluminum fuel tanks and atomizing much of the 10,000 gal of jet fuel liquid into a spray of fuel droplets. Atomized jet fuel is highly flammable (similar to kerosene), so both the hot debris and the numerous pieces of electrical and electronic gear in the offices were more than sufficient as ignition sources. A surge of combusting fuel rapidly filled the floors, mixing with dust from the pulverized walls and floor slabs. The pressure created by the heated gases forced the ignited mist out the entrance gash and blown-out windows on the east and south sides of the tower. The resulting fireballs could be seen for miles, precipitating many 9-1-1 calls.

Less than 15 percent of the jet fuel burned in the spray cloud inside the building. A roughly comparable amount was consumed in the fireballs outside the building. Thus, well over half of the jet fuel remained in the building, unburned in the initial fires. Some splashed onto the office furnishings and combustibles from the aircraft that lodged on the impacted floors, there to ignite (immediately or later) the fires that would continue to burn for the remaining life of the building. Some of the burning fuel shot up and down the elevator shafts, blowing out doors and walls on other floors all the way down to the basement. Flash fires in the lobby blew out many of the plate glass windows. Fortunately, there were not enough combustibles near the elevators for major fires to start on the lower floors.

## **2.5 8:47 A.M. TO 9:02 A.M. EDT**

The burning of the jet fuel cloud had consumed much of the oxygen within the 94<sup>th</sup> and 96<sup>th</sup> floors, although photographs showing survivors indicated there were some zones with breathable air. The oxygen-starved fires died down, but didn't quite go out. Within the first 2 min after the impact, fires could be seen in the north side windows on the 93<sup>rd</sup> through 97<sup>th</sup> floors, the 96<sup>th</sup> floor of the south face, and the 94<sup>th</sup> floor of the east face. As fresh air entered the perforated facades, there began the steady burning of the office furnishings and the 13 tons of combustibles from the aircraft that would eventually overwhelm the already damaged building. By 9:00 a.m., these fires had grown and spread to the extent shown in Figure 2-5. In addition to burning around the aircraft entrance hole, there was intense burning on the north, east, and west faces of the 97<sup>th</sup> floor. Large fires burned on the south side of the 96<sup>th</sup> floor and the east side of the 94<sup>th</sup> floor. At 8:52 a.m., a stream of smoke emerged from the south side of the 104<sup>th</sup> floor, although there was no evidence of a significant fire there yet.

There was no way to fight the fires. The piping providing the water supply to the automatic sprinklers had been broken, and water was flowing down the stairwells. Even had this not happened, the system was designed to supply water to about 8 sprinkler heads at one time, enough to control the flames from as much as 1,500 ft<sup>2</sup> of burning material. The water supply was likely sufficient to control fires up to triple that size. The fires, however, had already grown far larger than that.

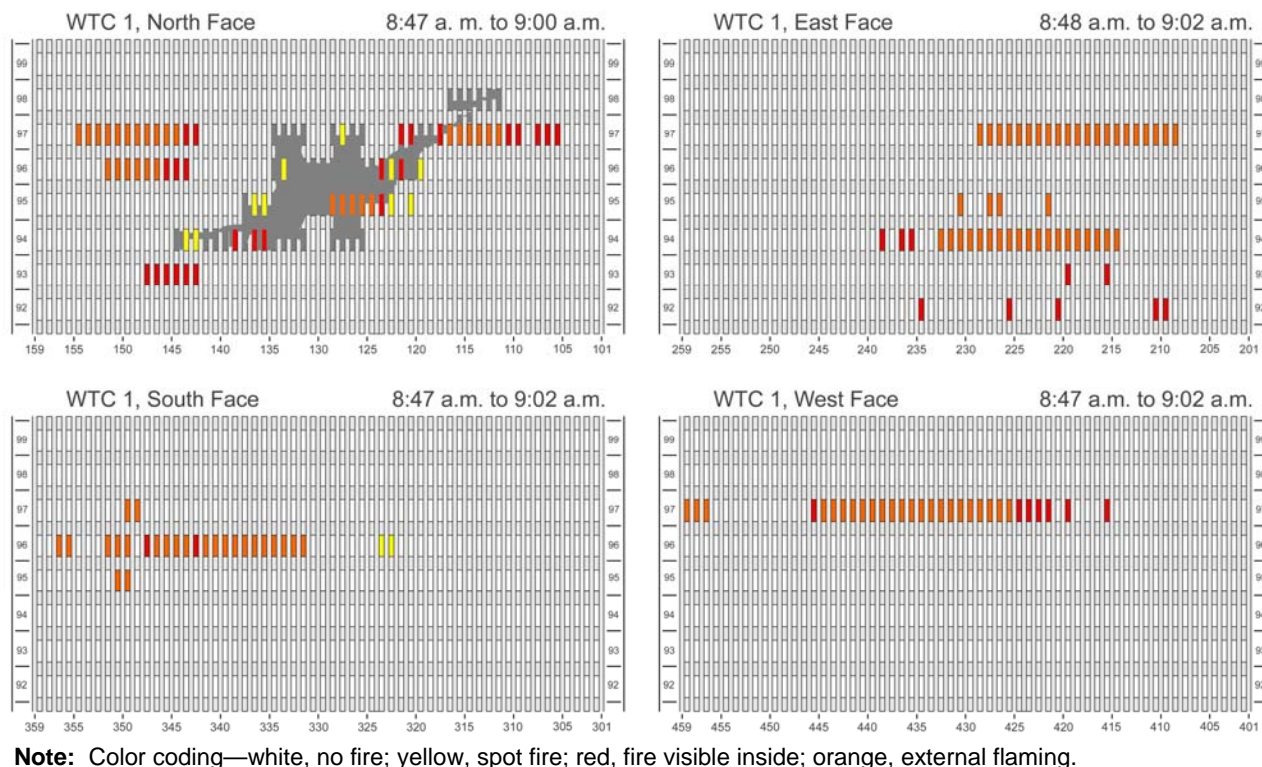

**Figure 2-5. Representation of exterior views of the fires on the four faces of WTC 1 from 8:47 a.m. to about 9:02 a.m.**

There was also no way to abate the opaque, hot, and toxic smoke that quickly began accumulating. The manually activated smoke purging system was intended for smoke removal during fire department operations following a fire. Thus, it was not turned on during the 102 min that the tower would remain standing. It would not likely have helped anyway. Neither the World Trade Center Safety Director nor the arriving firefighters knew where the fires were located, so they could not have known how to direct the intake and exhaust flows. Furthermore, the integrity of the vent shafts on the upper floors had been compromised by the aircraft impact, making it unlikely that the system could have functioned as intended.

Most of the people in WTC 1 were aware of the possibility of an emergency. A quarter of them had been working in the building since before the 1993 bombing, and most of those had been in the building on that day. Half the people had been working in the building for at least two years; many had heard the stories and had participated in the emergency drills.

The building occupants knew that something serious had happened. A third of the survivors had heard the roar of the plane. Nearly two thirds reported feeling the violent movement of the building. Half sensed that they were in a life-threatening situation. At the Concourse Level, a fatal fireball filled the space from the elevators to the exit toward WTC 3. Almost immediately, people began calling 9-1-1, both for help and to find out more about what was going on.

Within 5 min to 8 min of the strike, most of the 7,545 people below the floors of impact began to evacuate. Their progress is tracked in Table 2-1. Water and debris were in the three stairwells. The air smelled of jet fuel and was becoming gray with smoke and pulverized gypsum, thermal insulation, and

concrete. Nonetheless, perhaps due to the guidance they had received since the 1993 bombing, for the most part the people moved in an orderly manner down the stairs, helping those who needed assistance. Within 15 min of the strike, nearly all of the people below the impact floors had descended about 10 floors from their original location.

**Table 2–1. Locations of occupants of WTC 1.**

Time	Evacuated	Lobby to 91 <sup>st</sup> Floor	92 <sup>nd</sup> to 110 <sup>th</sup> Floor
8:46	0	7,545	1,355
9:03	1,250	6,300	1,355
9:59	6,700	850	1,355
10:28	7,450	107	1,355

**Note:** The numbers in the rows do not add to the estimated total of 8,900 due to rounding errors in the less certain values.

At the time, there were some survivors from the 92<sup>nd</sup> through 99<sup>th</sup> floors. Most of those who were able moved to the areas where the fires had not yet spread. Some were seen looking out from the former window spaces and even standing on the deformed structural steel. At 8:52 a.m., the first of at least 111 people was observed falling from the building.

Hundreds of people were on the floors above the impact zone. They soon realized that they were unable to go downward to get away from the smoke and heat that were building up around them. At 8:54 a.m., occupants began breaking windows to provide access to fresh air. By 9:02 a.m., 26 calls, representing hundreds of people, had been made to 9-1-1, asking for help and seeking more information about what was happening. Some of the people went toward the roof. However, there was no hope because roof evacuation was neither planned nor practical, and the exit doors to the roof were locked.

While the occupants were not advised in advance that roof evacuation was not a viable option, there was, and is, no requirement in the NYC Building Code for the roof to be accessible for emergency evacuation or rescue, and roof rescue was not contemplated in the WTC evacuation plans. Even had the roof been accessible, the helicopters could not have landed due to the severe heat and smoke.

Outside the building, a flurry of activity was beginning. Personnel of the Fire Department of the City of New York (FDNY) were several blocks away, investigating a gas leak at street level, and observed the aircraft impact. Within a minute, FDNY had notified its communications center and requested additional alarms for the WTC. A Port Authority Police Department (PAPD) unit had reported to its Police Desk that there had been an explosion with major injuries. By 8:50 a.m., the first fire engines had arrived, and an Incident Command Post had been established in the WTC 1 lobby. An Emergency Medical Service (EMS) Command was established 3 min later. More and more reports of damage, injuries, and deaths flooded the communications channels, and knowledge of the extent of the catastrophe was emerging. At 8:52 a.m., the first New York City Police Department (NYPD) aviation unit arrived to evaluate the possibility of roof rescue, but reported they were unable to land on the roof due to the heavy smoke. At 8:55 a.m., the firefighters entering WTC 1 began climbing the stairs (Figure 2–6). Their objectives were to evacuate and rescue everyone below the fires, then to cut paths through the fires and rescue all those above the fires.

At 8:59 a.m., a senior PAPD official called for evacuation of the entire WTC complex, although that call was not heard nor heeded by others. By 9:00 a.m., 66 FDNY units had been dispatched to the scene, and



**Figure 2–6. Firefighters on the scene at about 9:07 a.m.**

the FDNY had called a fifth alarm for the dispatch of additional department personnel and equipment to the WTC. Spectators had begun converging on the complex, but were advised to stand clear.

The aircraft impact also did damage to the communications in the tower. The capability for building-wide broadcast from the Fire Command Desk was knocked out. Emergency responder radio traffic peaked at about five times its normal traffic volume during the 20 min period after to the attack. This peak gradually tapered off, but still continued at a sustained level three times the normal traffic volume. The radio systems were not adequate to handle the high flow of emergency communications required for this scale of operations. Many of the radio messages were unintelligible because many individuals were trying to talk on the same radio channel at the same time.

## **2.6 9:02:59 A.M. EDT**

At 9:02:59 a.m., five hijackers flew United Airlines Flight 175 with 9 crew and 51 passengers into the east side of the south face of WTC 2. For the most part, there was little awareness of this among the people below the 92<sup>nd</sup> floor of WTC 1. Almost one-fifth of these had already left the building, and nearly all the 6,300 others were already in the stairwells.

## **2.7 9:03 A.M. TO 9:57 A.M. EDT**

A fire needs a continuing supply of both gaseous fuel and oxygen to keep burning, and the initially burning combustibles in WTC 1 were being consumed. The additional fuel came from the office furnishings next to those that were reaching the end of their burning life. The thermal radiation from the flames and from the hot gases heated the nearby combustibles, creating flammable vapors. These vapors needed a source of nearby air to continue the burning. The same flames and hot ceiling layer gases heated the windows and window frames in the vicinity. The hot gases pushed on the weakened aluminum

frames, sending some windows outward to fall to the Plaza below. Other windows were sucked into the building. The fires now had both new fuel and fresh air.

And so the fires continued to spread, likely aided by as-yet unburned jet fuel that had soaked into some of the furnishings and flooring. The coating of (non-combustible) gypsum and concrete fragments slowed the burning rate by as much as half, but could not halt the fire from spreading. The overall movement of the fires was toward the south side of the tower. By 9:15 a.m., the fires on the 97<sup>th</sup> floor had intensified and filled most of the floor. Large fires had erupted on the east sides of the 92<sup>nd</sup> and 96<sup>th</sup> floors.

Seventy-five minutes after the impact, approaching 10:00 a.m., the fire on the 97<sup>th</sup> floor had begun to burn itself out, but the fire on the 94<sup>th</sup> floor had intensified and filled much of the north half of the floor (Figure 2–7). Starting about 9:30 a.m., there were vigorous fires on nearly the full perimeter of the 98<sup>th</sup> floor. There was still almost no burning on the 99<sup>th</sup> floor or above.

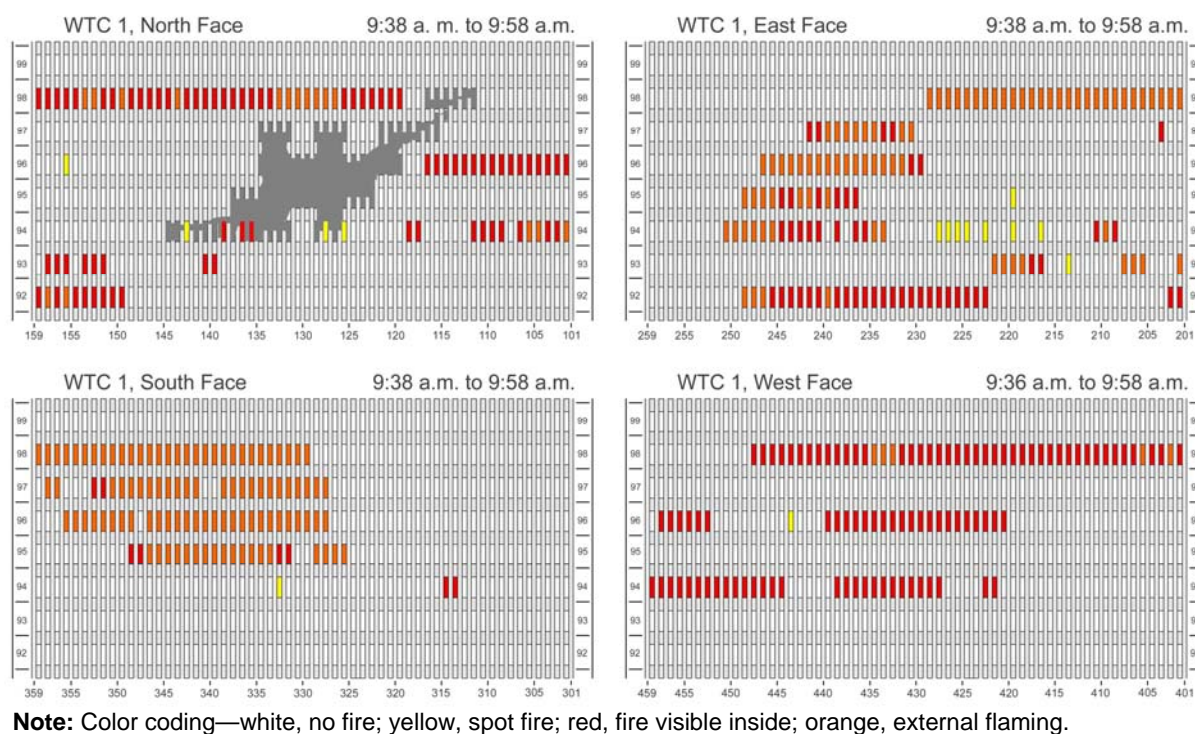

**Figure 2–7. Representation of exterior views of the fires on the four faces of WTC 1 from about 9:38 a.m. to 9:58 a.m.**

The hot smoke from the fires now filled nearly all the upper part of the tenant space on the impact floors. Aside from isolated areas, perhaps protected by surviving gypsum walls, the cooler parts of this upper layer were at about 500 °C, and in the vicinity of the active fires, the upper layer air temperatures reached 1,000 °C. The aircraft fragments had broken through the core walls on the 94<sup>th</sup> through the 97<sup>th</sup> floors, and temperatures in the upper layers there were similar to those in the tenant spaces.

The perimeter columns, floors, and core columns were immersed in these hot gases and began to weaken. Where the insulation was dislodged, the temperature of the steel rose rapidly, in contrast to steel members where insulation was intact (Figure 2–8). The heaviest core columns with damaged insulation heated slowly, as the absorbed heat was dissipated through their massive cross sections. The temperatures of the lighter columns and the floor slabs rose more quickly, and those of the stripped trusses even more so.

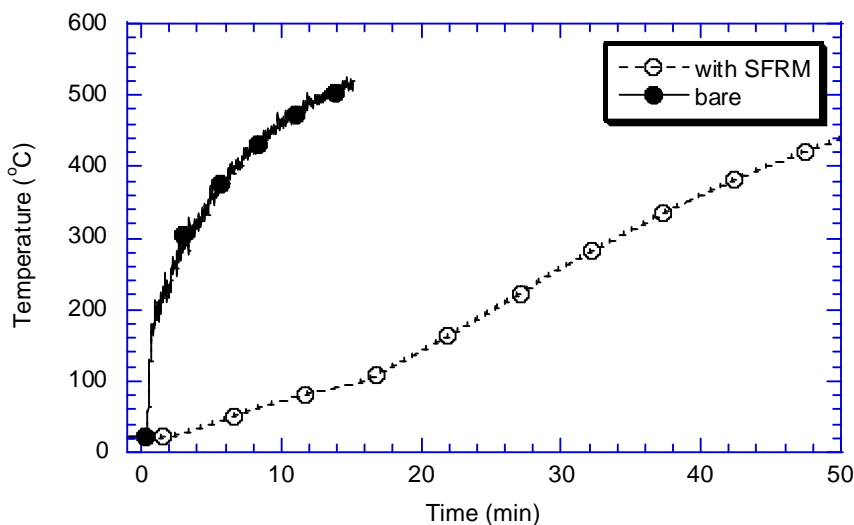

**Figure 2–8. Steel surface temperatures on the bottom chords of fire-exposed trusses, uninsulated and insulated with  $\frac{3}{4}$  in. of BLAZE-SHIELD DC/F.**

As a steel column is heated, its ability to support gravity loads and resist lateral loads decreases. At temperatures of about 300 °C, steel loses about 20 percent of its yield strength (Figure 2–9). Under modest loads, steel is *elastic*, that is, it can compress, or shorten, but will recover when loads are removed. As the load increases, the steel becomes *plastic*, and the shortening is unrecoverable. At still higher loads, the column buckles. At temperatures above 500 °C, the steel further weakens, the loss of strength and stiffness become significant, and the column’s ability to carry its share of the building loads decreases. It shortens due to a combination of plastic deformation and an additional, time-dependent deformation called *creep* that can increase column shortening and hasten buckling. Figure 2–10 indicates the rates at which structural steel could have been heated by the WTC fires and the effect of the thermal insulation in slowing the heating process.<sup>6</sup>

Structural steels do not need to melt to lose strength. Their melting points are about 1,600 °C, well above the 1,100 °C typical peak value reached by fires of common building combustibles.

At this point, the core of WTC 1 could be imagined to be in three sections. There was a bottom section below the impact floors that could be thought of as a strong, rigid box, structurally undamaged and at almost normal temperature. There was a top section above the impact and fire floors that was also a heavy, rigid box. In the middle was the third section, partially damaged by the aircraft and weakened by heat from the fires. The core of the top section tried to move downward, but was held up by the hat truss. The hat truss, in turn redistributed the load to the perimeter columns.

<sup>6</sup> Chapter 6 contains an explanation of how these temperature profiles were developed.

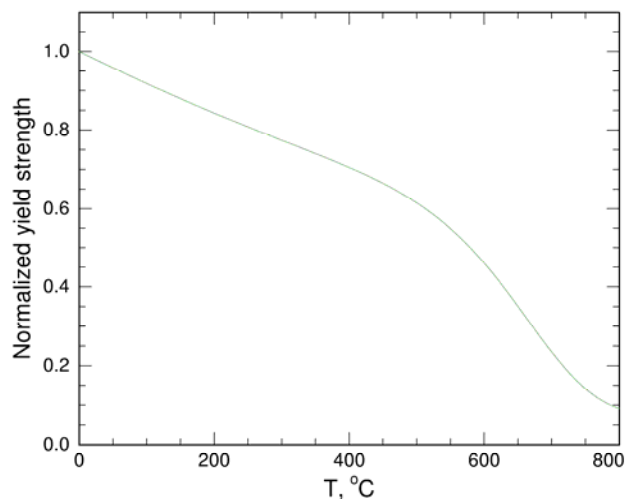

**Figure 2–9. Temperature dependence of yield strength of structural steel as a fraction of the value at room temperature.**

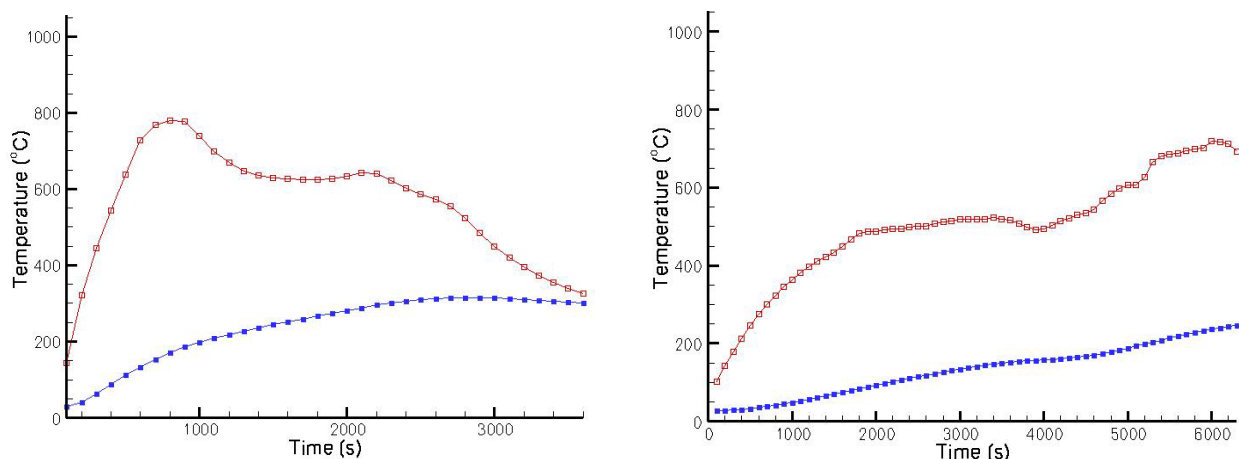

**Note:** The red data are for structural steel components without insulation; the blue data are for steel components that are still insulated.

**Figure 2–10. Simulated temperatures of two adjacent trusses (left) and two adjacent perimeter columns (right) exposed to the fires in WTC 1.**

Simultaneously, the fires were creating another problem for the tower. The floors of the 93<sup>rd</sup> through the 97<sup>th</sup> stories were being heated both by the hot gases from below and by thermal radiation from the fires on the floor above (Figure 2–11). On the south side of the building, where the fires were heating the long-span trusses whose SFRM had been dislodged, the floors began to sag. In so doing, they began pulling inward on their connections to the south face and to the core columns. Pull-in forces due to the sagging floors did not fail the floor connections in most areas.



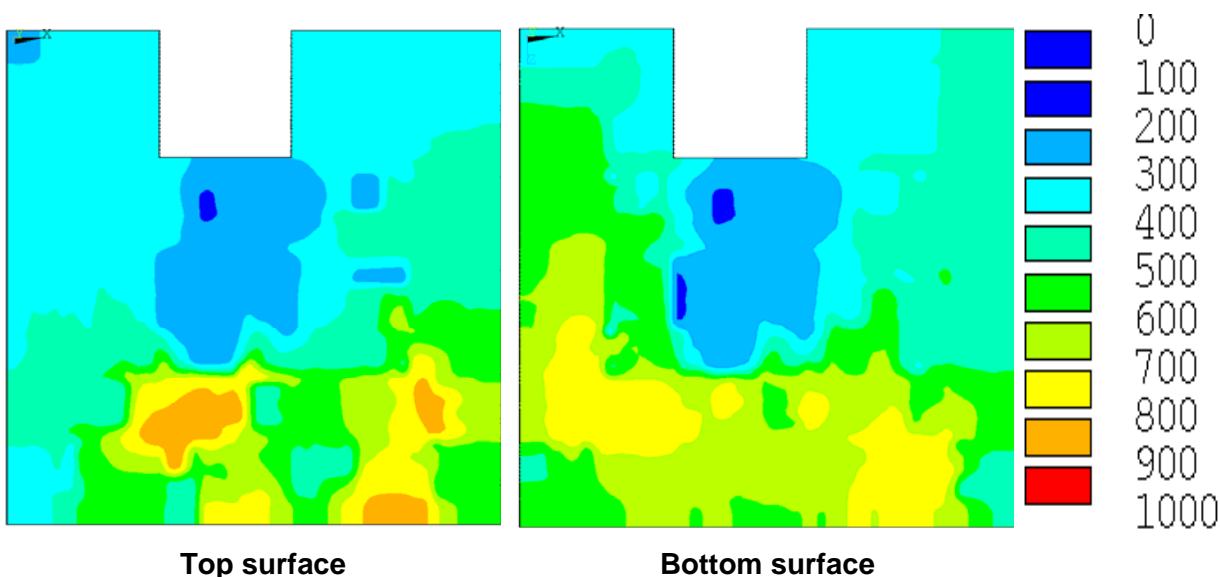

**Figure 2–11. Temperature contours (°C) on the top and bottom faces of the concrete slab (96<sup>th</sup> floor, WTC 1) at 100 min after impact. A portion of the concrete slab on the north face (top) was damaged by the impact of the aircraft.**

Meanwhile, the occupants from below the impact floors were moving steadily down the stairs at roughly a floor per minute. Although they encountered firefighters climbing upward, this did not slow the downward progress much. Within 75 min of the impact, 90 percent of the people who would survive had left WTC 1. At 9:37 a.m., a Port Authority official instructed all units to direct the evacuees over the bridge on West Street to the Financial Center. However, this change in evacuation route actually began with the collapse of WTC 2.

Conditions on floors 92 and above continued to deteriorate. The presence of the fires and the resulting high smoke and radiant heat levels made the 92<sup>nd</sup> floor through the 99<sup>th</sup> floor uninhabitable except in small areas. Above the impact zone, there were only seven calls to 9-1-1 between 9:03 a.m. and 9:10 a.m.; and then, more than a half hour later, three last calls from floors 104 and 105 between 9:43 a.m. and 9:57 a.m. More people jumped through windows they broke or that had been broken by the fires.

By 9:15 a.m., 30 FDNY units had signaled their arrival, and by 9:59 a.m., the number had grown to 74. They had been told to stop short of the site because of the large number of ambulances already there and the debris falling from the buildings. Many of the firefighters proceeded into WTC 1. Once inside, they found that only one of the 99 upward elevators was working, one that went as far as the 16<sup>th</sup> floor. Most of the firefighters then proceeded to ascend the three stairways, intending to help evacuate the occupants, cutting paths through the fires as necessary. Because the firefighters were carrying as much as a hundred pounds of bulky firefighting gear, their progress was slow and was impeded by the flow of evacuees coming down the stairs. A few reached as high as floors in the 40s and 50s.

Since the Command Boards were destroyed in the collapse, it is unknown just how many firefighters went into WTC 1, when they went in, or, in most cases, what level they reached.

## 2.8 9:58:59 A.M. EDT

With no warning that could be discerned in WTC 1, WTC 2 collapsed. The shudder as the more than 250,000 tons of steel, concrete, and furnishings hit the ground was felt well beyond the site. Seismic sensors located 100 miles away recorded the time and intensity of the event.

The gigantic concussion was felt by some of the nearly 800 people still in the stairwells in WTC 1. The evacuation rate slowed to half its prior level as a new cloud of dust, smoke, and debris filled the Concourse and the stairwells, and the lights went out. Higher up, no more calls to 9-1-1 originated from above the 91<sup>st</sup> floor.

At 10 a.m., NYPD and FDNY ordered all emergency responders out of WTC 1 and away from the WTC site.

## 2.9 9:59 A.M. TO 10:28 A.M. EDT

For the next half hour, the last 690 of the eventual survivors worked their way down the last flights of stairs, across West Street to the west and across Vesey Street to the north and to safety. By 10:28 a.m., all but 107 of the roughly 7,500 people who had been below the impact floors were able to escape.

Having heard over their radios the orders that they should evacuate, some of the responders inside the tower headed down the stairwells and out of the building, telling their comrades on the way. Others did not, having not received the message, having climbed too high to now get out in time, or continuing on the missions to help others still in the building.

A pressure pulse generated by the collapse of WTC 2 appeared to intensify the fires in WTC 1. Within 4 s of the collapse of WTC 2, flames burst from the south side windows of the 98<sup>th</sup> floor. The fires on the north faces of the 92<sup>nd</sup>, 94<sup>th</sup>, and 96<sup>th</sup> floors brightened noticeably. Flames near the south end of the east face of the 92<sup>nd</sup> and 96<sup>th</sup> floors also flared. The fires on the east and south faces of the 98<sup>th</sup> floor already extended out the windows. Those in the WTC 1 stairwells felt a gush of wind.

At 10:01 a.m., flames began coming out of the south side of the west face of the 104<sup>th</sup> floor, three floors higher than any floor where fire had been previously observed and five floors above the highest floor with a major fire. After a rapid growth period, this fire burned intensely up to the time the tower collapsed.

By 10:18 a.m., a substantial pressure pulse inside the building ejected jets of smoke from the 92<sup>nd</sup> and 94<sup>th</sup> through 98<sup>th</sup> floors of the north faces and the 94<sup>th</sup> and 98<sup>th</sup> floors of the west face. Fires raged on the south side of the 96<sup>th</sup> through 99<sup>th</sup> floors.

The sagging of the floors had increased. Although the floors on the north side of the tower had sagged first, they contracted due to cooling when the fires moved toward the south. Now, the south side floors had sagged to the point where the south perimeter columns bowed inward (Figure 2–12). By 10:23 a.m., the south exterior wall had bowed inward as much as 55 in.

At 10:06 a.m., an NYPD aviation unit advised that WTC 1 would come down and that all emergency vehicles should be moved away from it. At 10:20 a.m., observers in NYPD helicopters said that the top of the building was leaning; and at 10:21 a.m., they said that WTC 1 was buckling on the southwest corner and leaning to the south.

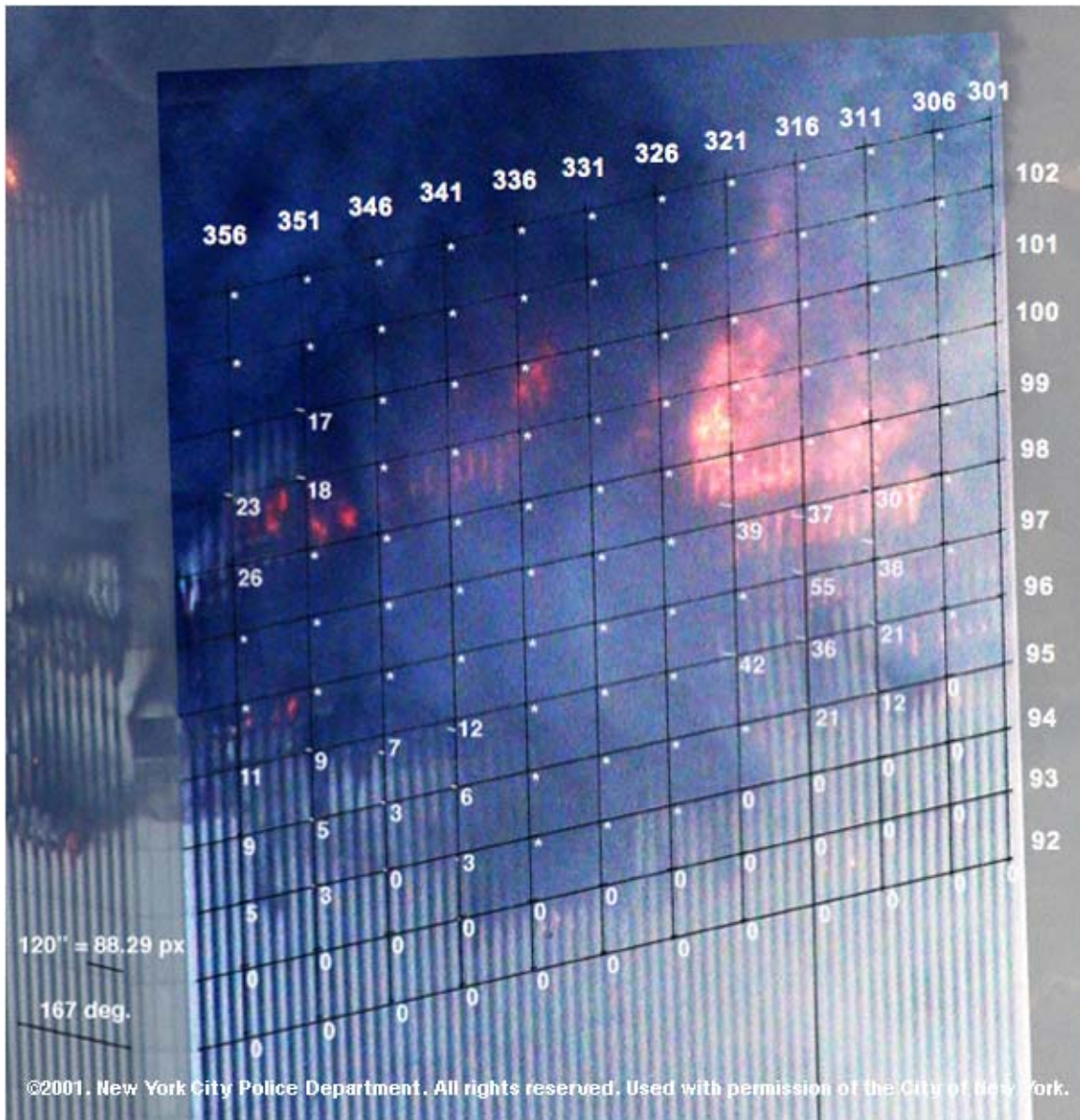

Note: Enhanced by NIST.

**Figure 2–12. South face of WTC 1 at 10:23 a.m., showing inward buckling (in inches) of perimeter columns.**

The tower was being overwhelmed. Three of the four major structural systems—the core, the floors, and the perimeter walls—were weakening. The south wall became unstable and tried to transfer its remaining load to the weakened core via the hat truss and to adjacent perimeter columns via the spandrels. The entire section of the building above the impact zone began tilting as a rigid block toward the south. The upper section of the building then collapsed onto the floors below. Within 12 s, the collapse of WTC 1 had left nothing but rubble.

## 2.10 THE OUTCOME

Seven major factors led to the collapse of WTC 1:

- Structural damage from the aircraft impact;
- Large amount of jet fuel sprayed into the building interior, that ignited widespread fires over several floors;
- Dislodging of SFRM from structural members due to the aircraft impact, that enabled rapid heating of the unprotected structural steel;
- Open paths for fire spread resulting from the open plan of the impact floors and the breaking of partition walls by the impact debris;
- Weakened core columns that increased the load on the perimeter walls;
- Sagging of the south floors, that led to pull-in forces on the perimeter columns; and
- Bowed south perimeter columns that had a reduced capacity to carry loads.

After the building withstood the initial aircraft damage, the timing of the collapse was largely determined by the time it took for the fires to weaken the core and to reach the south side of the building and weaken the columns and floor assemblies there.

There were no survivors among the 1,355 people who were on or above the 92<sup>nd</sup> floor. The aircraft had destroyed all egress paths downward, and roof rescue was impossible.

Of the roughly 7,545 building occupants who started that morning below the 92<sup>nd</sup> floor, all but 107 escaped the building. Those left behind were trapped by debris, awaiting assistance, helping others, or were just too late in starting their egress. For the most part, the evacuation was steady and orderly.

Six percent (almost 500) of the survivors from WTC 1 had a limitation that impaired their ability to evacuate. Many of these were able to evacuate, often with assistance; others were less fortunate. About 40 to 60 mobility-impaired occupants were found on the 12<sup>th</sup> floor, where they had been placed in an attempt to clear the stairways. Just before the collapse of WTC 1, emergency responders were assisting about 20 of these people down the stairwell. It remains unclear how many of these people survived.

Had the building been significantly more than one-third to one-half occupied, the casualties would likely have been far higher, since the exiting population would have exceeded the capacity of the stairwells to evacuate them in the time available.

Those emergency responders who entered the building and the emergency personnel who were already in the building were helpful in assisting the evacuation of those below the impact floors. However, there was insufficient time and no path to reach any survivors on the impact floors and above. Any attempts to mitigate the fires would have been fruitless due to the lack of water supply and the difficulty in reaching the fire floors within the time interval before the building collapse. It is not known precisely how many

emergency responders entered the building nor how many of the 421 responder casualties occurred in WTC 1. NIST estimated that approximately 160 FDNY fatalities occurred outside the WTC towers.

This page intentionally left blank.

## Chapter 3

# THE ACCOUNT OF WORLD TRADE CENTER 2

---

### 3.1 8:46:30 A.M. EDT

The nature of the events leading to the collapse of World Trade Center (WTC) 2 had a number of important features distinct from those of WTC 1. Those contrasts led to a larger overall fraction of the occupants surviving despite the building collapsing in a shorter period. As was the case with WTC 1, what follows is the result of an extensive, state-of-the-art reconstruction of the events that accompanied and followed the aircraft impact. Numerous facts and data were obtained, then combined with validated computer modeling to produce an account that is believed to be close to what actually occurred. The reader should again keep in mind that the building and the records kept within it were destroyed and the remains of the towers were disposed of before this Investigation began. As a result, there are some facts that could not be discerned, and there are uncertainties in this accounting. Nonetheless, the National Institute of Standards and Technology (NIST) was able to gather sufficient evidence and documentation to conduct a full investigation upon which to reach firm findings and recommendations. The reconstruction effort, the uncertainties, the assumptions made, and the testing of these assumptions are documented in Part II of this report.

The ordeal for the occupants of WTC 2 began at the same time as it did for those in WTC 1, when American Airlines (AA) Flight 11 struck WTC 1 at 8:46 a.m. Nearly all of the roughly 8,600 people in WTC 2 were well aware that something serious had occurred in the other tower. Half the people heard the terrible sound of the aircraft hitting WTC 1, just a few hundred feet away. One-fifth of the people saw the flames, smoke, or the debris ejected from the south side of WTC 1, over 10 percent felt WTC 2 moving, and another fifth in WTC 2 were quickly alerted to the seriousness of what had happened by co-workers, phone calls, or the morning news. Over half believed they were personally at risk.

Many began talking to each other, gathering personal items, and helping others. Fortunately, they began to get out of the building. Within 5 min, half the people had left their floor, and that fraction grew rapidly. About one-sixth used the elevators, with more of these people starting on the higher floors. The remainder divided themselves evenly among the three stairways. NIST estimated that approximately 3,000 people escaped because of the actions they took in the 16 min following the aircraft impact on WTC 1, especially their use of the elevators.

At 9:00 a.m. came the first building-wide public address system announcement that there was a fire in WTC 1, that WTC 2 was secure, and that people should return to their offices. This added confusion to an already tense situation, a situation that became even more turbulent when at 9:02 a.m., a contradictory announcement said that people may wish to start an orderly evacuation if conditions on their floor warranted.

### 3.2 9:02:59 A.M. EDT

Sixteen and a half minutes after the first impact, five hijackers flew United Airlines (UA) Flight 175, with 9 crew and 51 passengers, into WTC 2 at about 540 mph, about 100 mph faster than AA Flight 11 (Figure 3–1). UA 175 was also a Boeing 767-200ER and had also left Boston, bound for Los Angeles. It flew into WTC 2 carrying about 9,100 gal (62,000 lb) of jet fuel, evenly distributed between the inboard portions of the left and right wing tanks. The cargo bay held about 9 tons of luggage, mail, electrical equipment, and food. Combining this with the combustible cabin materials and luggage, the plane brought about 14 tons of solid combustibles into the tower with it.



Figure 3–1. Imminent impact of United Airlines Flight 175 with WTC 2.

### 3.3 THE IMMEDIATE DAMAGE

The aircraft completely disappeared into the building in a fifth of a second. In response to the force of the collision, the top of the tower swayed 27 in. to the north, taking 2.6 s to reach the maximum displacement. UA Flight 175 was heading approximately 15 degrees east of Plan North<sup>7</sup> when it hit the south face of WTC 2 about 23 ft east of the center. The off-center impact twisted the upper part of the tower in a counterclockwise movement. The building vibrated in the north-south direction, along with a twisting motion, with the amplitude decreasing steadily with each oscillation.

The center of the nose of the plane struck at the 81<sup>st</sup> floor slab. The plane was banked 38 degrees to the left (right wing upward) and was heading slightly (6 degrees) downward from the horizontal. Since the

---

<sup>7</sup> Plan North was approximately 29 degrees clockwise from True North.



bank angle was steeper than that of AA Flight 11, this entry wound stretched over nine floors, from 77 to 85, rather than eight in WTC 1 (Figure 3–2). The occupancy of those floors is shown in Table 3–1.

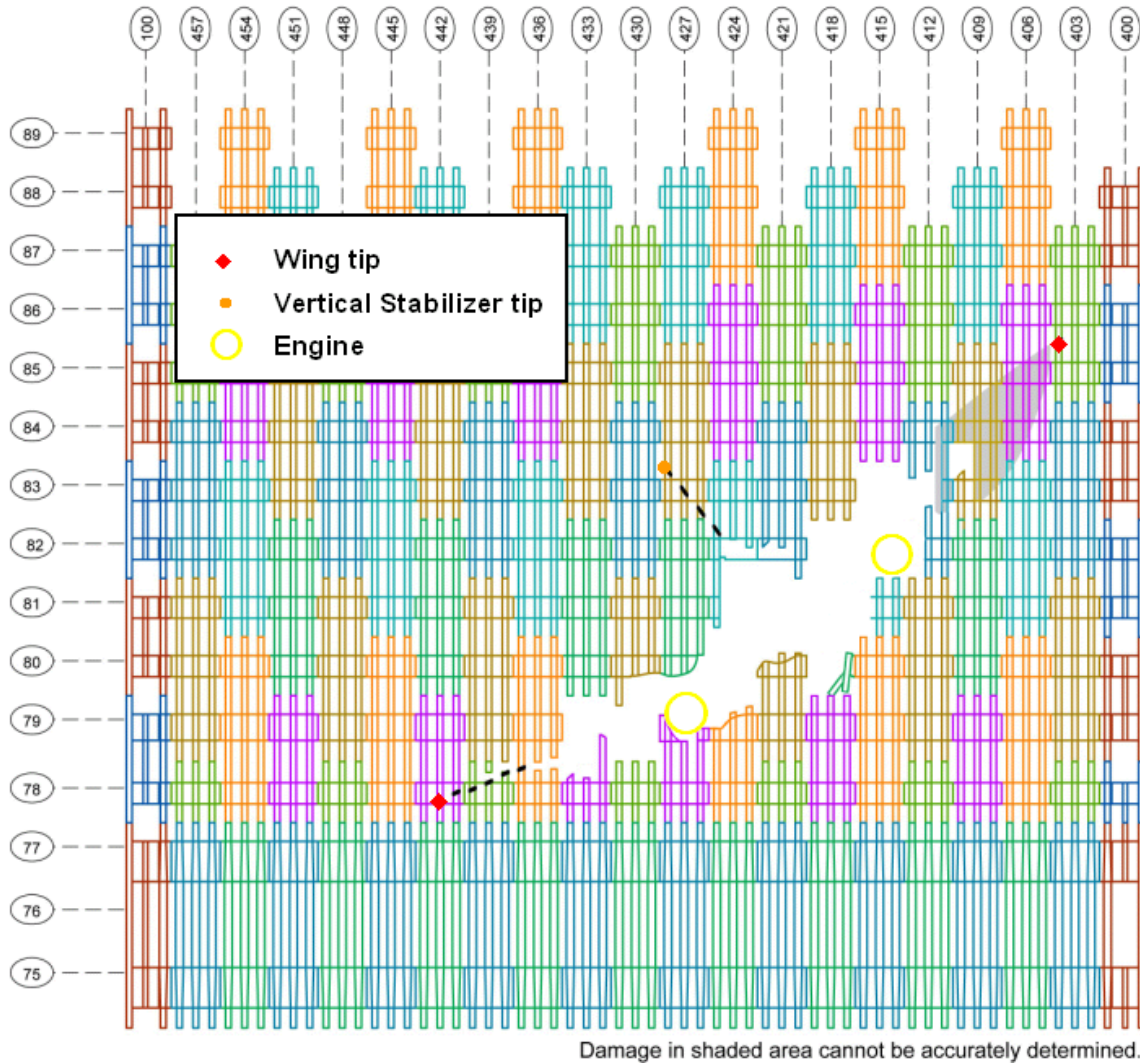

Figure 3–2. South face damage of WTC 2 with key aircraft component locations marked.

Table 3–1. Tenants on impact floors in WTC 2.

Floors	Tenant	Business
85	Harris Beach	Legal
84	Eurobrokers	Brokerage
83	Mitsui; IQ	Banking; Financial Software
79 through 82	Fuji Bank	Banking
77 and 78	Baseline	Investment Services

The bulk of the impact damage was confined to six floors. Figure 3–3 shows the combined damage. Floors 77, 84, and 85 were struck only by the outer extent of the wings. Empty of fuel, the light framing

and aluminum sheet of the wing did little damage to the building structure or the SFRM on the columns and trusses on these floors. There were 433 broken windows on the north, east, and south facades.

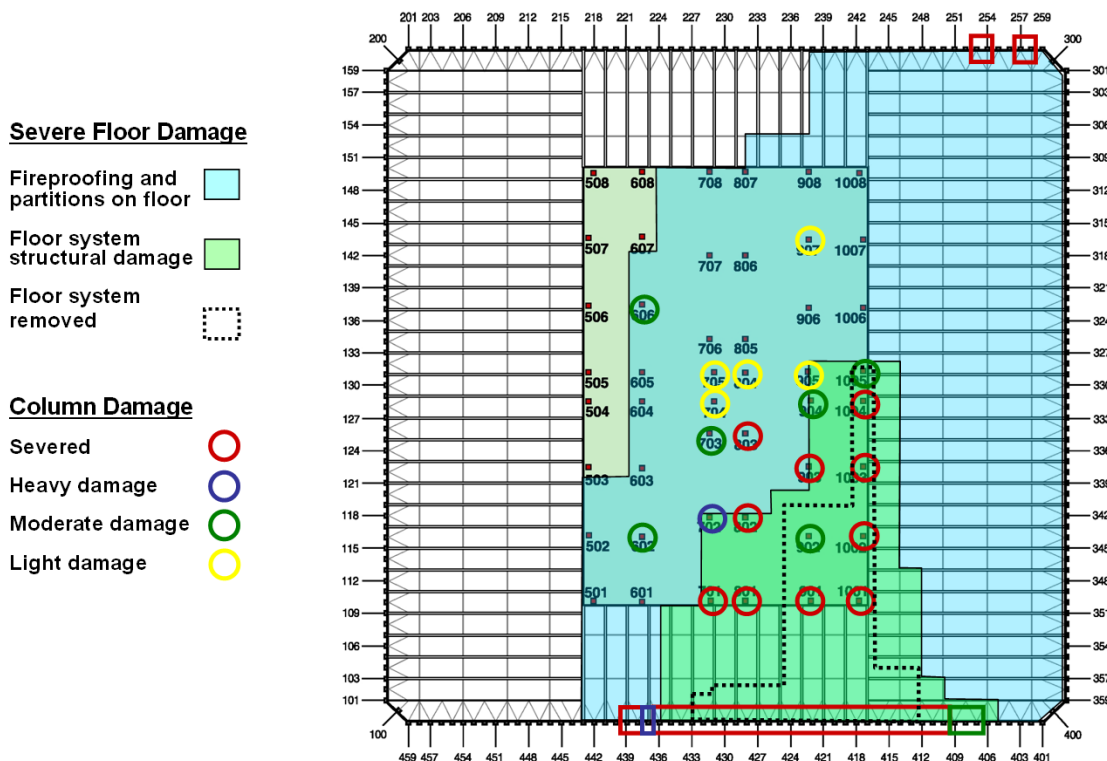

**Figure 3–3. Simulation of aircraft impact damage to the 78<sup>th</sup> through 83<sup>rd</sup> floors in WTC 2.**

The middle of the left wing hit the 78<sup>th</sup> floor, severing nine perimeter columns and breaking 19 windows on the south face. The SFRM was stripped from the floor trusses over the same width as the building core. The stripping of insulation from the trusses continued inward across the tenant space and about two thirds of the way into the core. There was no direct core column damage from the debris on this floor. However, the southeast corner core column was so damaged on the 80<sup>th</sup> floor that it broke at its splices on the 77<sup>th</sup> and 83<sup>rd</sup> floors.

There was heavier damage to the 79<sup>th</sup> floor. The left engine and the inboard section of the left wing shattered a 25 ft wide section of the center of the floor slab all the way to the core of the building and severed 15 perimeter columns. Reaching the building core, the debris severed nine columns, heavily damaged another, and abraded the SFRM from the eastern two thirds of the columns and trusses all the way to the north end of the core.

The damage was most severe on the 80<sup>th</sup> and 81<sup>st</sup> floors, hit directly by the fuselage. On the lower floor, a chunk of the floor slab was broken, just above the affected piece of the 79<sup>th</sup> floor. In addition, a 70 ft deep strip along the east side of the core floor was crushed. The north side floor slab sagged along its eastern end. Ten of the perimeter columns severed on the 79<sup>th</sup> floor were displaced here also. Within the building core, ten columns were severed, including many that were severed on the 79<sup>th</sup> floor. The SFRM was stripped not only from the eastern two thirds of the core structural elements, nearly to the north wall, but also from most of the trusses on the east tenant space, all the way to the north façade.

On the 81<sup>st</sup> floor, the fuselage pulverized a section of the floor 40 ft wide that extended into the southeast corner of the core. The SFRM and gypsum fire protection on the full depth of the east side of the core and in the entire east side of the tenant space was stripped. The structural damage to the core columns was limited to near the southeast corner, but as mentioned above, the impulses felt here caused damage to the key corner column all the way down to the 78<sup>th</sup> floor. The right engine passed all the way through the 81<sup>st</sup> floor, exited from the northeast corner, and damaged the roof of a building on Church Street, before coming to rest some 1,500 ft northeast of WTC 2 near the corner of Murray and Church Streets. The right landing gear assembly passed through the 81<sup>st</sup> floor at the east side of the north face and landed near the engine on the roof of a building on Park Place. (See Figure 1–1 for the street locations relative to the towers.)

The right engine hit the 82<sup>nd</sup> floor spandrels about 50 ft from the east edge of the building, crushing part of the 82<sup>nd</sup> floor slab. Along with the inboard section of the right wing, it severed eight to nine perimeter columns, including some to the east of those severed on the lower floors. The wing caused truss damage up to the southeast corner of the core and severed five columns. As on the 81<sup>st</sup> floor, the fire protection on the east side of the tenant space and the east side of the core was dislodged.

The 83<sup>rd</sup> floor caught the middle of the starboard wing. The east side floor slab appeared to be dislodged and sagged at least half of the way into the building.

The result of the core column damage was that the building core leaned slightly to the southeast above the impact zone. The tendency of the core to lean was resisted by the floors and the hat truss.

The direct impact of the aircraft was over in about 0.6 s. The structural and insulation damage, summed over all floors, was estimated to be:

- 33 exterior columns severed, 1 heavily damaged.
- 10 core columns severed, 1 heavily damaged.
- 39 of 47 core columns stripped of insulation on one or more floors.
- Insulation stripped from trusses covering 80,000 ft<sup>2</sup> of floor area

The tower swayed more than one foot back and forth in each direction on the impact floors, about one-third the sway under the high winds for which the building was designed. Nonetheless, just like WTC 1 across the Plaza, *WTC 2 absorbed the aircraft strike and remained standing.*

By 9:03 a.m., most of the people in WTC 2 had already left their usual work floors. Nearly 40 percent of all the occupants had left the building, (Table 3–2), and 90 percent of those who would survive had begun their evacuation. Many of those still on the east side of the impact floors were likely killed or seriously injured by the impact. The same was true for many of those on the 78<sup>th</sup> floor skylobby, who were deciding on a course of action, waiting for the express elevators to transport them to the ground floor, or attempting to return to their offices. Those on the west side of the building were less seriously affected. In calls to 9-1-1, they reported fallen ceiling tiles, collapsed walls, jet fuel, heat, smoke, and fire.

**Table 3–2. Location of occupants of WTC 2.**

Time	Escaped	Lobby to 76 <sup>th</sup> Floor	77 <sup>th</sup> to 110 <sup>th</sup> Floor
8:46	0	5,700	2,900
9:03	3,200	4,800	637
9:36	6,950	1,050	619
9:59	8,000	11	619

**Note:** The numbers in the rows do not add to the estimated total of 8,600 occupants due to rounding in the less certain values.

This aircraft had also severed the pipes that fed the automatic sprinklers and destroyed all elevator service to the impact floors. But, unlike AA Flight 11, the off-center strike of UA Flight 175 had left one of the three stairways passable, Stairway A on the north side of the building core.

When the aircraft struck WTC 2, emergency responders had already been dispatched to the WTC site, and the initial surge of emergency responder radio had subsided to a level approximately three times that of normal operations. However, the radio traffic volume was still at a level where approximately one-third to one-half of the radio communications was not understandable.

Stairwell A remained passable because it was well west of the aircraft strike center and partially protected by elevator machinery and the long dimension of the building core.

### 3.4 THE JET FUEL

Within about one half of a second, dust and debris flew out of windows on the east and north faces. Several small fireballs of atomized jet fuel burst from windows on the east face of the 81<sup>st</sup> and 82<sup>nd</sup> floors, coalescing into a single, large fireball that spanned the entire face. A tenth of a second later, fire appeared in the dust clouds ejected from the south face of the 79<sup>th</sup>, 81<sup>st</sup>, and 82<sup>nd</sup> floors. Almost simultaneously, three fireballs came from the east side of the north face. The largest came from the 80<sup>th</sup> through 82<sup>nd</sup> floors. A second, somewhat smaller one came from the same floors on the northeast corner of the building. The smallest emerged from the 79<sup>th</sup> floor. No dust or fireballs came from the west face.

As in WTC 1, less than 15 percent of the jet fuel burned in the spray cloud inside the building. Roughly 10 percent to 25 percent was consumed in the fireballs outside the building. Thus, well over half of the jet fuel remained after the initial fireballs.

The rapid burning of the jet fuel inside the building created an overpressure that was estimated at 2 psi to 3 psi for 0.5 s to 2 s. For a window and frame of over 10 ft<sup>2</sup>, this amounts to over 3,000 pounds of force, more than enough to break windows. Photographs of the north and east faces appeared to show hanging floor slabs where the fireballs had been ejected from the building. Based on the failure of the truss seat connections, NIST estimated that the static capacity of an undamaged floor was 4.8 psi against uplift pressure and 4.4 psi against downward pressure over the entire floor. It is not unreasonable that a combination of physical damage from the impact and overpressure from the fireballs caused the partial collapse of these floor slabs.

### 3.5 9:03 A.M. TO 9:36 A.M. EDT

The fireballs burned for 10 s, extending almost 200 ft out from the north, east, and south faces. Having consumed the aerosol fuel, the flames then receded.

For the next half hour, small fires were burning in and near the aircraft impact cavity on the south side of the building. There were vigorous fires on the east side of the 80<sup>th</sup> through 83<sup>rd</sup> floors (Figure 3–4), especially on the northeast end of the 81<sup>st</sup> and 82<sup>nd</sup> floors, where the aircraft had bulldozed the office desks and chairs and added its own combustibles. In addition to the ample supply of fuel, these fires had access to plenty of air, as numerous windows on the east face had been blown out by the impact or fireball. They would continue to burn as long as the building stood.

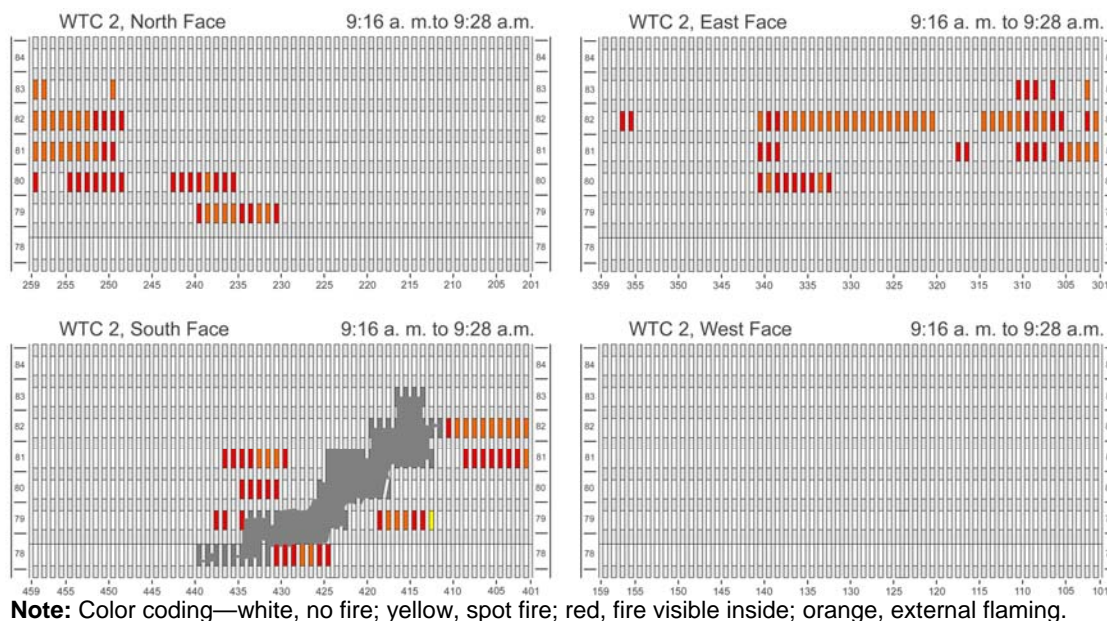

**Figure 3–4. Representation of exterior views of the fires on the four faces of WTC 2 at about 9:20 a.m.**

Between 9:30 a.m. and 9:34 a.m., there were several large bursts of smoke from the 79<sup>th</sup> and 80<sup>th</sup> floors of the north face, possibly resulting from the ignition of pools of jet fuel that had settled there, or from shifting of dislodged floor slabs elsewhere.

Direct structural changes were occurring in the building interior. Core columns, including the massive southeast corner column, had been severed by the aircraft. The loads from these columns had been redistributed to other, intact core columns and to the east exterior wall. The core leaned to the south and east, restrained from further movement by the east and south walls through the floors and the hat truss.

The fires were weakening the structure in a manner different from WTC 1. First, the severed core columns in the southeast corner led to the failure of some column splices to the hat truss. Nonetheless, the hat truss continued to transfer loads from the core to the perimeter walls. Second, the overall load redistribution increased the loads on the east wall. Third, the increasing temperatures over time on the long-span floors on the east side had led to significant sagging on the 79<sup>th</sup> through 83<sup>rd</sup> floors, resulting in an inward pull force. Fourth, within 18 min of the aircraft impact, there was inward bowing of the east perimeter columns as a result of the floors sagging. As the exposure time to the high temperatures lengthened, these pull-in forces from the sagging floors increased the inward bowing of the east perimeter columns.

Meanwhile, people continued their evacuation. By 9:36 a.m., almost 7,000 of the 8,600 occupants had left the building. From the impact floors and above, 18 occupants had discovered that the hot, smoke-filled, debris-laden Stairway A was not fully blocked and had made their way to survival. It is not known how many more of the 619 other people who had been on or above the impact floors became aware of this, but none made it out of the building. There are no records of information regarding this escape route having been collected and transmitted to others who might have been able to use it.

The PAPD, NYPD, and FDNY centers were now being inundated with calls from the two buildings. In the confusion, some of the callers did not identify which building they were in. At 9:12 a.m., PAPD was notified that the WTC 2 floor warden phones were not working. Other calls alerted them to trapped and injured people. At 9:18 a.m., FDNY reported that they had a single elevator working to floor 40. A simultaneous call indicated that FDNY was relocating its command post across West Street. At 9:30 a.m., EMS set up a triage desk in the lobby of WTC 2.

### **3.6 9:36 A.M. TO 9:58 A.M. EDT**

By 9:58 a.m., all but eleven of the occupants who had been below the impact floors had left the building and crossed the street to safety.

The fires continued to burn in the east half of the building.

At 9:55 a.m., firefighters communicated that they had reached floor 55 of WTC 2, one of the few calls for which a record survived indicating how high the responders had reached. Before WTC 2 collapsed, firefighters had reached the 78<sup>th</sup> floor by using the single functioning elevator to the 40<sup>th</sup> floor and then climbing the stairs.

The physical condition of the tower had deteriorated seriously. The inward bowing of columns on the east wall spread along the east face. The east wall lost its ability to support gravity loads, and, consequently, redistributed the loads to the weakened core through the hat truss and to the adjacent north and south walls through the spandrels. But the loads could not be supported by the weakened structure, and the entire section of the building above the impact zone began tilting as a rigid block to the east and south (Figure 3–5). Column failure continued from the east wall around the corners to the north and south faces. The top of the building continued to tilt to the east and south, as, at 9:58:59 a.m., WTC 2 began to collapse.



**Figure 3–5. Photograph of WTC 2 tilting to the southeast at the onset of collapse.**

### **3.7 THE OUTCOME**

Seven factors led to the collapse of WTC 2:

- Direct structural damage from the aircraft impact, which included more severe damage to the core columns than in WTC 1;
- Jet fuel sprayed into the building interior, that ignited widespread fires over several floors;
- Dislodging of SFRM from structural members due to the aircraft impact and aircraft and building debris, which enabled rapid heating of the unprotected structural steel;
- Sustained fires on the east side of the tower and an ample air supply;
- Weakened core columns that increased the loads on the perimeter walls;

- Sagging of the east floors, that led to pull-in forces on the east perimeter columns; and
- Bowed east perimeter columns that had a reduced capacity to carry loads.

After the building withstood the initial aircraft damage, the timing of the collapse was largely determined by the time for the fires to weaken the perimeter columns and floors on the east and south sides of the building. That the aircraft impact damage to the core was more severe in WTC 2 than in WTC 1 contributed to the shorter time to collapse.

The loss of life in WTC 2 was significantly reduced by the prompt start of evacuation activity before the tower was hit by the aircraft. Only a quarter of those initially on or above the impact floors died when the building collapsed, as contrasted with 100 percent in WTC 1. Eighteen people on those upper floors found that one stairwell was passable in time to evacuate. Whether others found this escape route is unknown.

As with WTC 1, had the building been more than one-third occupied, the casualties would have been far higher as the population would have exceeded the capacity of the stairwells to evacuate them in the time available.

Of the roughly 6,000 people who started the morning below the 77<sup>th</sup> floor, all but 11 evacuated the building, indicating sufficiently efficient movement within the three stairwells within the time available.

Even more than in WTC 1, those emergency responders who entered WTC 2 and the emergency personnel who were already in the building were helpful in assisting the evacuation of those below the impact floors. However, there was insufficient time to reach any survivors on the impact floors and above. Any attempts to mitigate the fires were fruitless due to the lack of water supply and the difficulty in reaching the fire floors within the time interval before the building collapse. It is not known precisely how many emergency responders entered the building nor how many of the 421 emergency responder casualties occurred in WTC 2.



## Chapter 4 THE TOLL

By sunset on September 11, 2001, all seven buildings on the World Trade Center (WTC) site lay in ruins (Figure 4–1). Table 4–1 compiles the likely locations of the decedents.

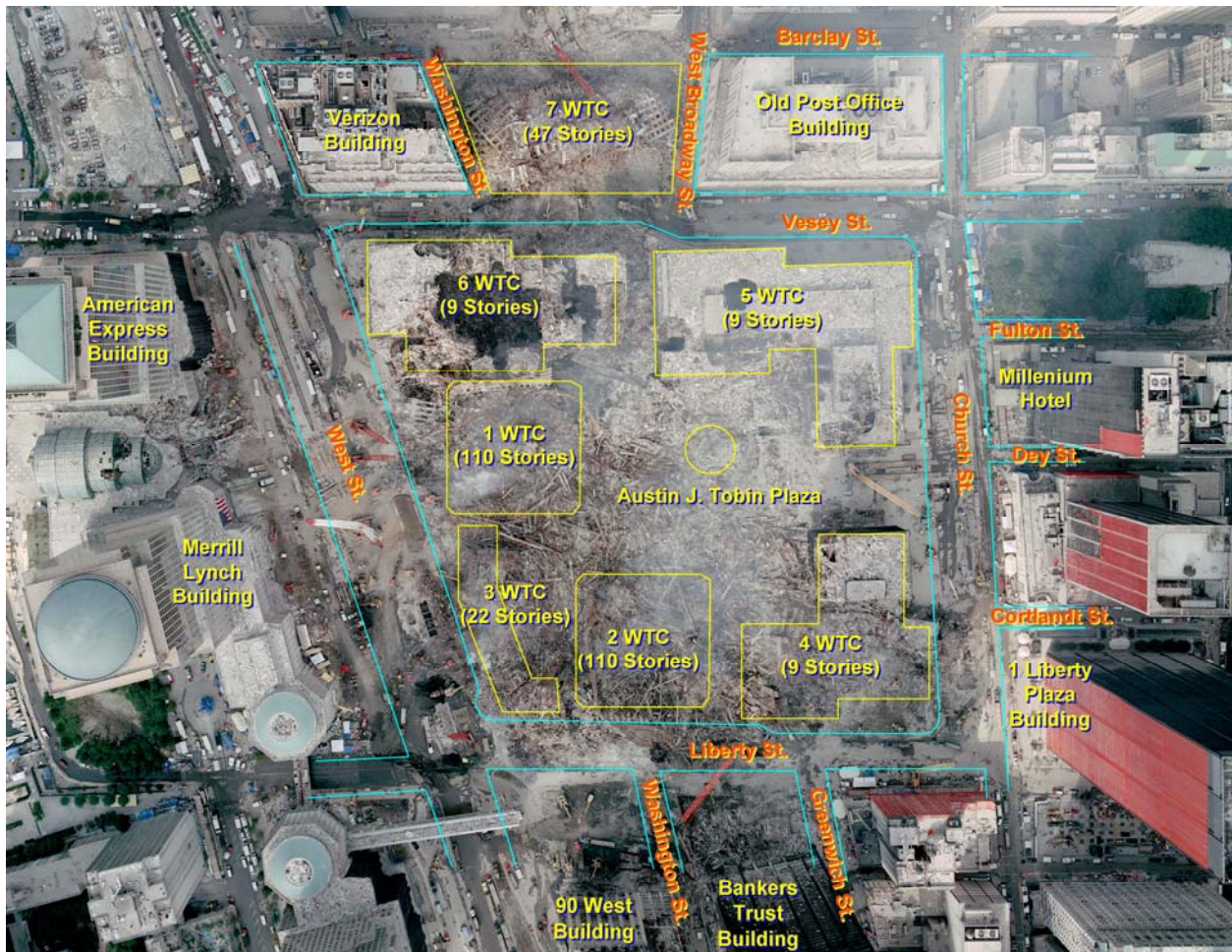

Source: National Oceanographic and Atmospheric Administration.

Figure 4–1. The WTC site on September 17, 2001.

**Table 4–1. Likely locations of WTC decedents at time of impact.**

<b>Location<sup>a</sup></b>	<b>Number</b>
<b>WTC 1 Occupants (Total)</b>	<b>1,462</b>
At or Above the Impact Floors	1,355
Below the Impact Floors	107
<b>WTC 2 Occupants (Total)</b>	<b>630</b>
At or Above the Impact Floors	619
Below the Impact Floors	11
<b>Confirmed Below Impact Zone in WTC 1 or WTC 2</b>	<b>30<sup>b</sup></b>
<b>Unknown Location Inside WTC 1 or WTC 2</b>	<b>24<sup>c</sup></b>
<b>Emergency Responders (Total)</b>	<b>421<sup>d</sup></b>
FDNY	343
NYPD	23
PAPD	37
Hospital/Paramedic	7
Federal	2
Volunteer Responders	9
<b>Bystander/Nearby Building Occupant</b>	<b>18</b>
<b>American Airlines Flight 11</b>	<b>87<sup>e</sup></b>
<b>United Airlines Flight 175</b>	<b>60<sup>e</sup></b>
<b>No Information</b>	<b>17</b>
<b>Total</b>	<b>2,749</b>

- a. Where possible, NIST used eyewitness accounts to place individuals. Where no specific accounts existed, NIST used employer and floor information to place individuals.
- b. These individuals were typically security guards and fire safety staff who were observed performing activities below the floors of impact after the aircrafts struck.
- c. These 24 individuals were largely performing maintenance, janitorial, delivery, safety, or security functions.
- d. Emergency responders were defined to be people who arrived at the site from another location. Thus, security staff and Port Authority staff (different from PA Police Officers) were not defined as emergency responders.
- e. Does not include the five hijackers per aircraft.

## **PART II: RECONSTRUCTING THE DISASTER**

---

This page intentionally left blank.

## Chapter 5

# THE DESIGN AND CONSTRUCTION OF THE TOWERS

---

### 5.1 BUILDING AND FIRE CODES

Codes for the design, construction, operation, and maintenance of buildings are the blueprints by which a society manifests its intent to provide public safety and welfare. They incorporate the knowledge, experience, procedures and practices of the applicable engineering disciplines, the values of the contemporary society, the experiences from prior successes and failures, and knowledge of the commercial products, services, and technologies available for the tasks at hand.

In the United States, building and safety regulations of state and local jurisdictions are most frequently based on national “model” building codes (model codes). Developed under the auspices of private sector organizations in an open process, the model codes include minimum requirements for public health, safety, and welfare. The model codes are traditionally organized into volumes according to the official responsible for their enforcement and include a building code, fire code, plumbing code, electrical code, mechanical code, etc. The model codes adopt by reference voluntary consensus standards developed by a large number of private sector standards development organizations. These standards include measurement methods; calculation methods; data sets; and procedures and practices for design, construction, operation, and maintenance.

The model codes and referenced standards do not become law until they are adopted legislatively or administratively by a jurisdiction empowered to enforce regulations, for example, a state or city. These jurisdictions may modify specific provisions of the models codes and referenced standards to suit local conditions or traditional practices. Once legally adopted, the totality of the modified model codes and standards are referred to as building regulations.

Proposals to modify the model codes, offered by individuals or organizations, are discussed in open forums before being accepted or rejected by a voting process. Localities adopting model codes update their versions periodically as well, but typically not on the same schedule. To a lesser and decreasing extent, some jurisdictions have generated their own building codes to reflect specialized local conditions and preferences. The Federal government’s role in determining specific codes is minimal and not mandatory (except for federally owned, leased, regulated, or financially assisted properties).

There are also key stakeholder groups that are responsible for or influence the practices used in the design, construction, operation, and maintenance of buildings in the United States through the code development process. These include organizations representing building owners and managers, real estate developers, contractors, architects, engineers, suppliers, and insurers. (Infrequently, members of the general public and building occupants participate in this process.) These groups also provide training, especially as it affects the ability to implement code provisions in practice, since lack of adequate training programs can limit the application of improved code provisions.

## 5.2 THE CODES AND THE TOWERS

### 5.2.1 The New York City Building Code

The New York City (NYC) Building Code was and is part of the Administrative Code of New York City. Until recently, the various versions of the Code were not based on any model code, but rather were written by local code development committees. However, there are many similarities between the versions of the NYC Code and the model codes of the same time, since they all reflected accepted practice.

The NYC Code has been amended from time to time by Local Laws to update safety requirements or to incorporate technological advances. These Local Laws were enacted by the New York City Council. To aid the implementation of and to clarify building code requirements, New York City issued mandatory “rules” that were typically initiated by City Government offices and issued under authority of the Building Commissioner.

At the time the WTC project began in the early 1960s, the 1938 NYC Building Code was in effect. In 1960, reflecting growing dissatisfaction with the failure of the Code to keep pace with changes that had occurred in the building industry, the Building Commissioner requested the New York Building Congress to form a working committee to study the problem. On December 6, 1968, Local Law 76 repealed the 1938 code and replaced it with the 1968 code. As is the general custom with changes to building codes, the new provisions did not apply to buildings approved under the prior code, provided they did not represent a danger to public safety and welfare, or until they underwent a major renovation or change in primary use.

The 1968 NYC Building Code also included “Reference Standards.” These included standard test methods and design standards published by standards development organizations. Some of these Reference Standards included modifications to the published standards, as well as stand-alone standards developed by New York City.

Through 2002, 79 Local Laws had been adopted that modified the 1968 Building Code. The major Local Law affecting the structural design of buildings dealt with seismic provisions. Five of the Local Laws had provisions that pertained to fire protection and life safety that were of interest to the WTC Investigation:

- Local Law 5 (1973) added, among other specifications, requirements for:
  - Compartmentation (subdivision) within upper story, unsprinklered, large floor areas. Its provisions applied retroactively to existing office buildings.
  - Signs regarding the use of elevators and stairs, also retroactive.
  - A fire alarm system for buildings more than 100 ft in height.
- Local Law 55 (1976) added a requirement for inspection of all sprayed fire protection, effective immediately but not retroactive.
- Local Law 33 (1978) added a requirement for trained fire wardens on each floor.

- Local Law 86 (1979), among other provisions, required full compliance with Local Law 5 by February 7, 1988, and exempted fully sprinklered buildings from compartmentation requirements.
- Local Law 16 (1984) added requirements for sprinklers in new and existing buildings taller than 100 ft. Since Local Law 5 only required compartmentation of non-sprinklered spaces, this negated the compartmentation requirements from Local Law 5.

The World Trade Center (WTC) was located in Manhattan and would normally have been designed and constructed according to the NYC Building Code of 1938. However, the WTC was constructed by The Port Authority of New York and New Jersey (The Port Authority or PANYNJ) on land that it owned. As an interstate agency established under a clause of the United States Constitution permitting compacts between states, The Port Authority's construction projects were not required to comply with any building code. Nonetheless, The Port Authority instructed its consultants to design the two towers to comply with the 1938 NYC Code. In 1965, The Port Authority directed the architect and consulting engineers to revise their designs for the towers to comply with the second and third drafts of what would become the 1968 NYC Code. The rationale for this step was that the new Code allowed the use of advanced techniques in the design of the WTC, as well as more lenient provisions regarding exit stairs and the reduced fire ratings. To reaffirm a "long standing policy" of The Port Authority that its facilities meet or exceed NYC Building Code requirements, a formal memorandum of understanding between The Port Authority and the New York City Department of Buildings was established after the bombing in 1993.

## **5.2.2 Pertinent Construction Provisions**

To gain perspective on the conditions under which the WTC towers were constructed, the rationale for the design, and the building structures themselves, the National Institute of Standards and Technology (NIST) and its contractors reviewed tens of thousands of pages of documents provided by The Port Authority and its contractors and consultants, Silverstein Properties and its contractors and consultants, the Fire Department of the City of New York, the NYC Police Department, the NYC Law Department, the NYC Department of Design and Construction, the NYC Department of Buildings, the NYC Office of Emergency Management, the manufacturers and fabricators of the building components, the companies that insured the WTC towers, and the building tenants.

NIST deemed it important to understand how the provisions under which the WTC was constructed and maintained compared to equivalent provisions in place elsewhere in the United States at that time. The Investigation selected three codes for comparison:

- The 1964 New York State (NYS) Building Code, which governed construction outside the New York City limits
- The 1965 Building Officials and Code Administrators (BOCA) Basic Building Code, a model building code typically adopted by local jurisdictions in the northeastern region of the United States
- The 1967 Municipal Code of Chicago, under which the Sears Tower (110 stories) and the John Hancock Center (100 stories) were built

For the most part, the provisions in the various codes were similar, if not identical, indicating that there was a common understanding of the essentials of building safety and that the codes were at similar stages of evolution:

- There were only modest differences among the codes in the provisions for gravity loads.
- All three of the contemporaneous building codes had provisions for wind loads that were less stringent than those used for the tower design.
- None of the codes had provisions for design against progressive collapse.
- For alterations or additions to a building, there were criteria to determine whether the whole building or only the alterations needed to comply with the current code requirements. The “trigger” was either the fraction of the building cost involved in the renovation or the fraction of the building dimensions. The 1968 NYC Building Code was slightly less conservative than the Chicago Code and the BOCA Code. The NYS Code required that any addition or alteration conform to the contemporary code.
- The 1968 NYC Building Code required inspection of sprayed fire protection, but did not specify if testing was required.
- Only the NYC Building Code contained provisions for bracing (lateral support to prevent buckling of columns and walls) and stresses associated with transverse deflections of structural members.

NIST examined the 2001 edition of the NYC Building Code to determine the extent to which Local Laws had modified the code provisions between the times of construction and collapse of the towers. The 2001 edition of the NYC Building Code was essentially the same as the 1968 edition, as amended by the intervening Local Laws.

### 5.2.3 Tenant Alteration Process

With hundreds of tenants, The Port Authority realized that many would want extensive modifications to their space, both before they moved in and during the course of their occupancy. In anticipation, The Port Authority:

- Set up a special office to review and approve plans, issue variances, and conduct inspections.
- Developed a formal tenant alteration process for any modifications to leased spaces in WTC 1 and WTC 2 to maintain structural integrity and fire safety. The *Tenant Construction Review Manual*, first issued in 1971, contained the technical criteria, standards, and review criteria for use in planning alterations (architectural, structural, mechanical, electrical, and fire protection). Alteration designs were to be completed by registered design professionals, and as-built drawings were to be submitted to The Port Authority. The 1968 NYC Building Code was referenced. The review manual was updated four times and supplemented, in 1998, by the *Architectural and Structural Design Guidelines, Specifications, and Standard Details*.



The interiors of the towers had been heavily modified over the years due to tenant turnover, same-tenant space usage changes, the addition of sprinklers, and asbestos abatement.

## **5.3 BUILDING DESIGN**

### **5.3.1 Loads**

The NYC Building Code specified minimum design values for both dead and live gravity loads and for lateral (wind) loads.

- Each tower was designed to support dead loads (its own weight) consistent with the provisions in the 1968 NYC Building Code. The dead loads included the weight of the structural system and loads associated with architectural, mechanical, plumbing, and electrical systems.
- Each tower was designed to support live loads (the combined weights of the people and the building contents) exceeding those specified in the 1968 NYC Building Code.
- The design wind loads used in the towers were higher than those required by the 1968 NYC Building Code and the three other codes identified earlier.

### **5.3.2 Aircraft Impact**

The accidental 1945 collision of a B-25 aircraft with the Empire State Building sensitized designers of high-rise buildings to the potential hazards of such an event. However, building codes did not then, and do not currently, require that a building withstand the impact of a fuel-laden commercial jetliner. A Port Authority document indicated that the impact of a Boeing 707 aircraft flying at 600 mph was analyzed during the design stage of the WTC towers. However, the investigators were unable to locate any documentation of the criteria and method used in the impact analysis and were thus unable to verify the assertion that "...such collision would result in only local damage which could not cause collapse or substantial damage to the building and would not endanger the lives and safety of occupants not in the immediate area of impact."<sup>8</sup> Since the ability for rigorous simulation of the aircraft impact and of the ensuing fires are recent developments and since the approach to structural modeling was developed for this Investigation, the technical capability available to The Port Authority and its consultants and contractors to perform such an analysis in the 1960s would have been quite limited.

### **5.3.3 Construction Classification and Fire Resistance Rating**

Building codes classify building constructions into different "Types" or "Classes." The Class pertinent to the WTC towers was Class 1 (fire resistive). The 1938 NYC Building Code had no subdivisions of Class 1 construction, which required a 4 hour fire resistance rating for columns and a 3 hour rating for floors. The 1968 version of the Code subdivided Class 1 for office occupancies into 1A, with requirements identical to the 1938 Class 1, and 1B. Class 1B specified a 3 hour rating for columns and

---

<sup>8</sup> Letter with an attachment dated November 13, 2003, from John R. Dragonette (Retired Project Administrator, Physical Facilities Division, World Trade Department) to Saroj Bhol (Engineering Department, PANYNJ).

girders supporting more than one floor and a 2 hour rating for floors including beams. There were no height or area requirements that differentiated between Class 1A and Class 1B, and the towers could have been classified as either one. The Port Authority elected to provide the fire protection in the WTC towers with Class 1B standards.

Achieving a specified rating for a truss-supported floor using a sprayed fire-resistive material (SFRM) was an innovation at the time of the WTC design and construction. NIST was not able to find any evidence that there was a technical basis to relate SFRM thickness to a fire resistance rating, nor was there sufficient prior experience to establish such thickness requirements by analogy. NIST did find documentation that the Architect of Record and the Structural Engineer of Record had each written to The Port Authority, stating that the fire rating of the WTC floor system could not be determined without testing. NIST was unable to find any indication that such tests were performed nor any technical basis for the specification of the particular SFRM product selected or its application thickness.

The NYC Building Code required inspection at the time of application of the SFRM, to be conducted under the supervision of a building inspector or a licensed design professional who assumed responsibility for compliance. This inspection included verification of the thickness of the material, its density, and its adhesion, each using a specific ASTM test method. The Code contained a requirement that SFRM installed in areas where it was subject to mechanical damage be protected and maintained in a serviceable condition.

There were no code requirements nor general practice by which sprayed fire-resistive material was to be inspected over the life of the building.

#### 5.3.4 Compartmentation

Both the 1968 NYC Building Code and The Port Authority practice required partitions to separate tenant spaces from each other and from common spaces, such as the corridors that served the elevators, stairs, and other common spaces in the building core. These were intended to limit fire spread on a floor and to prevent the spread of a fire from one tenant space to that of another.

- The Port Authority specified partitions separating tenant spaces from exit access corridors to have a 2 hour rating. This allowed dead end hallways to extend to 100 ft (rather than 50 ft with 1 hour partitions), which permitted more flexibility in tenant layouts. Above the ceiling, penetrations for ducts or to allow for return airflow were fitted with rated fire dampers to preserve the fire rating. This 2 hour rated construction was not used in the original design, but was specified later by The Port Authority as tenant spaces were altered.
- For walls separating tenant spaces to achieve a 1 hour rating, they needed to continue through any concealed spaces below the floor and above the ceiling. The Port Authority chose to stop these demising walls at the bottom of the suspended ceiling and use 10 ft strips of 1 hour rated ceiling on either side of the partition. There was no precedent for this approach and, after a warning from the general contractor, the tenant alteration guidelines required that tenant partitions have a continuous fire barrier from top of floor to bottom of slab.
- There were no requirements in the 1968 NYC Building Code or in The Port Authority guidelines for partitions wholly within tenant spaces. As mentioned in Section 1.2.2, these

gypsum board walls generally ran from the floor slab to just above the suspended ceiling, although some extended to the slab above when the tenant desired additional sound attenuation. For these partitions to be fire rated, the ceiling would have had to be rated as well but were not required to be so.

- Enclosures for vertical shafts, including stairways and transfer corridors, elevator hoistways, and mechanical or utility shafts were required to be of 2 hour fire rated construction. These innovative walls are further described below.

There was a conflict regarding the number of partitions within a tenant space. On the one hand, the design of the WTC towers was intended to provide about 30,000 ft<sup>2</sup> per floor of nearly uninterrupted space and access to views of the Manhattan panorama. On the other hand, Local Law 5 dictated compartmentation into no more than 7,500 ft<sup>2</sup> areas for unsprinklered spaces. These areas could be increased to 15,000 ft<sup>2</sup> if protected by 2 hour fire resistive construction and smoke detectors. The compartmentation limit was removed when complete sprinkler protection was provided. Following a 1975 fire, The Port Authority began installing sprinklers at the time a new tenant moved in. By September 11, 2001, the installations had been completed throughout the towers, and, in general, the tenants on the impact floors had few internal partitions except for those surrounding conference rooms and executive offices.

Firestopping materials are used to fill gaps in walls and floors through which smoke and flames might pass. Such passage could negate the fire endurance value of the wall or floor. The 1968 NYC Building Code included comprehensive requirements identifying when and where firestopping was required. The 1964 New York State Building Code addressed the issue in less detail, and the Chicago Building Code had no requirements. The National Fire Protection Association (NFPA) Life Safety Code had firestopping requirements for exterior and interior partitions at floor levels, and did allow a trade-off for sprinklered concealed spaces. In the towers, unlike many buildings, the exterior wall was connected with the floors without gaps.

### 5.3.5 Egress Provisions

The primary egress system for the office spaces was the three stairways located in the building core. There were four main requirements for these stairways: number, width (including separate width requirements for the doors), separation of the doors to the stairways, and travel distance to the stairway doors.

The number of stairways and the width of the doors resulted from the implementation of the 1968 edition of the NYC Building Code, whose provisions were less restrictive than those in the 1938 edition. The 1968 code eliminated a fire tower (an enclosed staircase accessed through a naturally ventilated vestibule) as a required means of egress and reduced

The NYC Building Code used the "units of exit width" method for specifying exit capacity, in which each 22 in. unit of exit width provided the capacity for 60 people. Thus each 44 in. stairwell provided for 120 people and the 56 in. stairwell provided 2½ units, or 150 people, for a total occupant load per floor of 390.

the number of required stairwells from six to three<sup>9</sup> and the width of the doors leading to the stairs from 44 in. to 36 in.

Of the three staircases, two (designated A and C) were 44 in. wide; stairway B was 56 in. wide. The largest occupant load in the office spaces was 365 people per floor (36,500 ft<sup>2</sup> on the largest floor, with 100 ft<sup>2</sup> per person). Neither the 1968 NYC Building Code nor any of the contemporaneous codes mandated consideration of the number of building stories in determining the number and widths of the stairwells.

For the floors classified in the office use group (all floors except the observation deck and restaurant/meeting spaces), a minimum of two stairwells would have been required to serve the occupants, each equally sized. The three modern building codes considered in this report [International Building Code (IBC) (2000), NYC Building Code (2003), and NFPA 5000 (2003)], as well as the 1968 NYC Building Code, were consistent in this requirement, each regardless of building height. However, the resulting width of these minimum requirements would differ. Two 44 in. stairwells would have satisfied IBC minimum requirements, two 65 in. stairwells would have satisfied NFPA 5000 requirements, and two 78 in. stairwells would have satisfied the 1968 and 2003 NYC Building Code requirements. Alternatively, as was built at WTC 1 and WTC 2, three stairwells of narrower construction, but equivalent or greater total required width, would also satisfy the egress requirements in the modern building codes.

The 1968 NYC Building Code contained a requirement that the stairwells be “as far apart as practicable.” Since the stairwells on the impact floors of WTC 1 were substantially closer together than those on the impact floors of WTC 2, it certainly was possible to have designed a greater separation in WTC 1. Local Law 16 (1984) added a quantitative requirement that the separation between exit door openings be at least one-third of the maximum travel distance of the floor. For the WTC towers, this maximum distance was 180 ft, and the smallest separation of stairwell doors was 70 ft. The towers were consistent with this requirement.

NFPA 5000 (2003) and IBC (2000) incorporate a requirement that the separation of the stairwells be no less than one-third the overall diagonal length of the building. For the towers this length was 294 ft, and one-third was 98 ft. Thus, the stairwell separations on some floors would have been inconsistent with the later codes (with which the buildings in New York City were not required to comply).

At the top of the two towers were floors that were classified as public assembly floors: the Windows on the World restaurant complex in WTC 1 (floors 106 and 107) and the Top of the World observation deck in WTC 2 (floor 107). The design number of occupants on each of these floors was over 1,000. On September 11, 2001, there were about 188 people in the Windows on the World and few in the Top of the World since it was before the opening hour. Thus, had the stairwells remained passable through the impact region, the capacity would have been sufficient for the occupant load observed on that morning. Nonetheless, the egress requirements for assembly occupancy were more stringent than for business occupancy in both the NYC Building Code in 1968 and in 1996, when the Windows on the World re-opened after refurbishment following the 1993 bombing in the basement. NIST found documentation that, in 1996, The Port Authority created areas of refuge consistent with the provisions of the 1968 NYC

---

<sup>9</sup> See discussion of the required number of stairwells later in this section.

Building Code, but NIST was unable to find evidence indicating that the requirements for the number of exits for the evacuation of over 1,000 people from each of these floors had been considered in the design or operation of the buildings. In 1995, the NYC Department of Buildings, however, had reviewed the egress capacity from these floors and apparently concurred that the proposed remodel to these spaces would meet the intent of the NYC Building Code.

Subsequently, NIST communications in 2005 with The Port Authority and the NYC Department of Buildings identified a difference of interpretation regarding the number of exits required to serve these floors. The Port Authority stated that a fourth exit was not required since the assembly use space in question constituted less than 20 percent of the area of principal use, with principal use area defined as the entire building. The Department of Buildings stated that the 20 percent rule did not apply to assembly spaces such as restaurants and observation decks that are open to the public, and therefore exit reduction cannot be applied and a fourth exit was required.

The Department further clarified that areas of refuge and horizontal exits are not to be credited for required means of egress (unless the spaces are used non-simultaneously) and that for places of assembly, with occupant load in excess of 1,000, the floor shall have a minimum of four independent means of egress (stairs) to street. If the floor were divided into areas of refuge with rated walls, as was the case for the WTC towers, each area is to be considered an independent place of assembly that needs its own access to two means of egress (stairs) without going through another assembly space if they have an occupant load of less than 500 each (or three means of egress if the area of refuge had an occupant load between 500 and 999). Further, since the only means of egress from the roof-top deck was through the space on the observation floor, the Department clarified that occupant load from the deck would need to be added to the occupant load of the observation floor and that the travel distance from the roof deck along the connecting stairs to the required means of egress at the observation floor shall be within the maximum permitted by the NYC Building Code. The Department, however, did not raise the issue of a fourth stairwell in its December 1994 meeting with The Port Authority and when it subsequently concurred with The Port Authority's proposal to remodel the spaces.

Given the low occupancy level on September 11, 2001, NIST found that the issue of egress capacity from these places of assembly, or from elsewhere in the buildings, was not a significant factor on that day. It is conceivable that such a fourth stairwell, depending on its location and the effects of aircraft impact on its functional integrity, could have remained passable, allowing evacuation by an unknown number of additional occupants from above the floors of impact. If the buildings had been filled to their capacity with 20,000 occupants, the required fourth stairway would likely have mitigated the insufficient egress capacity for conducting a full building evacuation within the available time.

The elevator system was described in Chapter 1. These were not to be used for emergency evacuation except under the control of the fire department. Roughly 3,000 of the people who were initially at or above the impact floors in WTC 2 and were warned by the attack on WTC 1 survived, however, in large part by taking the elevators downward before the aircraft struck WTC 2.

Following the 1993 bombing, The Port Authority instituted the following changes to reduce egress time, in addition to those stairwell improvements mentioned in Section 1.1.2:

- Construction of new egress corridors, north (to Church Street and Vesey Street) and south (to Liberty Street) for faster evacuation from the Concourse (mall), and of two escalators from

the Concourse (mall), one to the plaza at WTC 5 and one up to WTC 4 and onto Church Street.

- Semiannual fire drills in conjunction with the FDNY.
- Appointment of Fire Wardens, specially trained and equipped with flashlights, whistles, and identifying hats.

## Building Communications

WTC emergency procedures specified that all building-wide announcements were to be broadcast from the Fire Command Desk (FCD), located in the lobby of each WTC tower (Figure 5–1), using prepared text. A situation requiring evacuation for any reason, including fire or smoke, would have led to the following announcement, enabling a phased evacuation:

“Your attention please. We are experiencing a smoke condition in the vicinity of your floor. Building personnel have been dispatched to the scene and the situation is being addressed. However, for precautionary reasons, we are conducting an orderly evacuation of floors \_\_\_\_\_. Please wait until we announce your floor number over the public address system. Then follow the instructions of your fire safety team. We will continue to keep you advised. We apologize for the inconvenience and we thank you for your cooperation.”<sup>10</sup>

A Fire Command Desk (Figure 5–1) was located in the lobby of each tower. The computer screen monitored the fire alarms, smoke sensors, sprinkler water flow, elevator lobby smoke detectors, fire signal activation, air handling fans, status of elevators, and troubles with the fire systems.

The announcement to be used when a particular floor required an evacuation was:

“Your attention please. It is now time for your floor to be evacuated. In accordance with the directions from your fire safety team, please take the exit stairs nearest to your location. We remind you that communications, emergency lighting and other essential services are in service. We will continue to keep you advised. We apologize for the inconvenience and we thank you for your cooperation.”<sup>10</sup>

At the discretion of the Fire Safety Director, the information and instructions broadcast to the building occupants could be modified to suit the nature of the emergency.

---

<sup>10</sup> The Port Authority of New York and New Jersey. World Trade Center Emergency Procedures Manual 2001.



**Figure 5–1. Fire Command Desk in WTC 1, as seen from a mezzanine elevator, looking west.**

### 5.3.6 Active Fire Protection

The provision of fire safety in the WTC towers revolved around a Fire Safety Plan that provided direction for fire emergency response and was organized around a hierarchy of staff trained in its implementation. In charge in each tower was the Fire Safety Director, who oversaw emergency response until the arrival of the Fire Department of the City of New York (FDNY), gathered necessary information, and relayed it to the Fire Chief upon arrival. In an emergency, the Fire Safety Director proceeded to the FCD or the fire scene. He/she had one or more Deputy Fire Safety Directors located at the FCD and at the sky lobbies. The front line was a set of Floor Wardens and Deputy Floor Wardens who were responsible for assessing conditions and assisting the evacuation of occupants on their respective floors. The Floor Wardens had their own communications system.

Built into each tower were four resources to mitigate the effects of a fire: an alarm system to alert people to the presence of the fire, an automatic sprinkler system and a standpipe system for controlling the fire by the application of water, and a smoke venting system to improve visibility as people proceeded toward exits. The primary documentation of the design, installation, maintenance, and modification of these systems was stored on the 81<sup>st</sup> floor of WTC 1 and was lost when that building collapsed. Contractors to the Investigation Team were able to re-create descriptions of the physical systems and their capabilities from limited duplicate information provided by The Port Authority, Silverstein Properties, Inc, and contractors, consultants, and operators involved with the systems.

The original fire alarm system used the technology current at the time and was engineered exclusively for the World Trade Center towers. The 1993 bomb explosion in WTC 1 destroyed the communications to the Operations Control Center, and the alarm system was revealed to be vulnerable to a single point of failure. Repair was problematic, since spare parts for the 25-year-old system were unavailable, and the software was no longer supported. The Port Authority immediately commissioned a new state-of-the-art system for WTC 1, WTC 2, WTC 4, WTC 5, and the subterranean levels. This retrofit involved the installation of over 10,000 detectors, pull stations, and monitors; 30,000 notification devices (speakers

and strobe lights); 150 miles of conduit; and 1,000 miles of wiring. Redundant Operations Control Centers were located in the basements of both towers.

The primary monitoring and control of the fire alarm system was performed at the FCD located in the lobby of each building. The new system included:

- Numerous interconnected microprocessors located in each of the four WTC buildings.
- Smoke sensors located throughout the tenant spaces, at each elevator landing, in return air ducts, and in electrical and mechanical rooms.
- At least one manual fire alarm station installed in each story in the evacuation path.
- Emergency voice and alarm speakers for notification and communication in all areas within the buildings, designed to ensure system function in the event 50 percent of the system became inoperable.
- Automatic notification of the fire department upon fire alarm activation.
- Two-way communications stations at the remote fire panels, at the Floor Warden stations, and at the standpipes.
- A two-way telephone system for the firefighters to make announcements.
- Emergency voice and alarm communication capability, both under manual control at the FCD.
- Strobe lights to provide alarm indications for the hearing impaired.
- Water flow indicators for the fire sprinkler system, including indicators for disabled systems.

No documentation of the status of the replacement system survived the 2001 attack. However, a 2002 analysis estimated that over 80 percent of the towers had been retrofitted and that about 25 percent of the original system was still in use.

Although there were localized carbon dioxide and halon systems within the towers, the Safety Plan predominantly relied on water for containing and suppressing a fire (Figure 5–2). By September 11, 2001, automatic sprinklers had been installed throughout WTC 1 and WTC 2.<sup>11</sup> The New York City water distribution system supplied water to the complex from two independent connections located under Liberty Street to the south and Vesey Street to the north. Within each tower were six 5,000 gal water storage tanks, three located on the 110<sup>th</sup> floor and one each on the 20<sup>th</sup>, 41<sup>st</sup>, and 75<sup>th</sup> floors. These were filled from the domestic water supply in the building. In the event of a fire, the gravity-fed water would flow to as many of the thousands of installed sprinklers as had been activated. The WTC engineering staff would supply additional water upward from the city mains using manually

---

<sup>11</sup> The exceptions to this were the computer rooms (protected with halon and carbon dioxide systems), kitchens (protected with dry chemical and steam smothering systems), mechanical spaces on the 108<sup>th</sup> through 110<sup>th</sup> floors, and the electrical rooms throughout the buildings, for which the application of water would have been inappropriate.



started pumps located in the towers; the FDNY could augment the supply using fire department connections and truck-based pumps. While there were redundant vertical supply pipes, there was only a single connection to the array of sprinklers on any given floor.

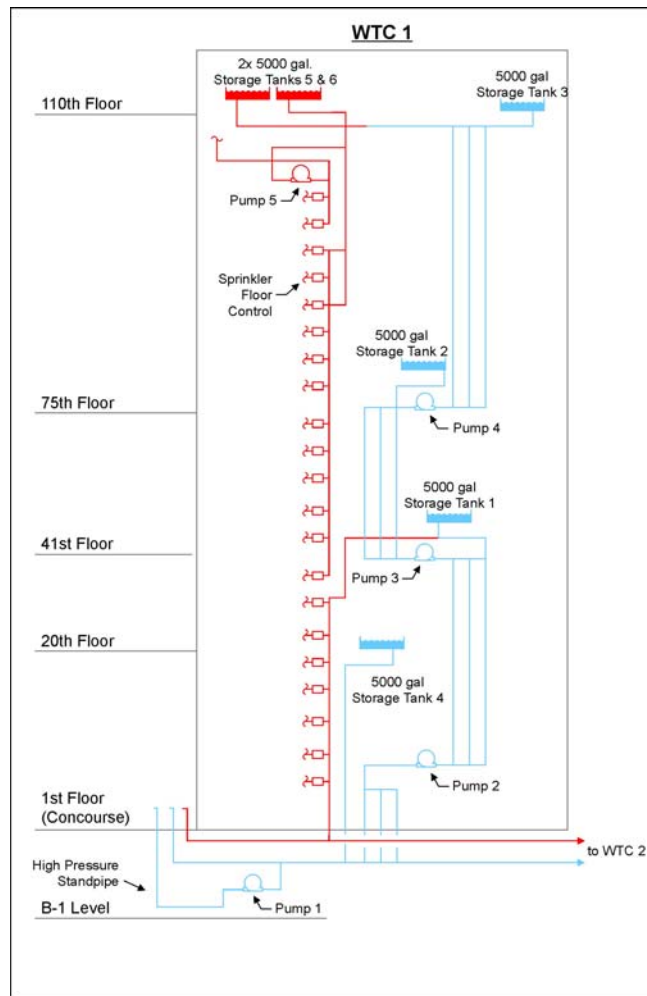

**Figure 5–2. Schematic of sprinkler and standpipe systems.**

The WTC towers were constructed with a manually activated (by Port Authority staff at the direction of FDNY) smoke purge system, use of which was integrated into The Port Authority’s WTC Fire Safety Plan. The system was designed to meet the 1968 NYC Building Code and was functional by September 11, 2001. The non-dedicated system used the existing building ventilation system, in contrast with an alternative dedicated system that would have been used only for smoke management. Each tower was divided into three zones, with the blowers located on the mechanical equipment floors (7, 41, 75, and 108). In the smoke purge mode, the mechanical system was aligned so that an entire zone was vented; there was no provision to vent an individual floor. The smoke from the impact floors in WTC 1 would have been drawn upward to the 108<sup>th</sup> floor, while the smoke from the impact floors in WTC 2 would have been drawn downward to the 75<sup>th</sup> floor. The system was designed to clear the zone of smoke after the fire was extinguished, perhaps during post-fire cleanup operations, lest the forced air increase the burning intensity.

## **5.4 BUILDING INNOVATIONS**

### **5.4.1 The Need for Innovations**

Had the towers been built according to conventional design, they would have been heavier and would have had less usable space on each floor. Thus, a resourceful approach was taken in translating The Port Authority's needs and Yamasaki's design into practice.

The Investigation Team identified six innovations incorporated in the lateral-load-resisting system and the gravity-load-carrying system of the towers. Their roles were discussed in Chapter 1. In addition, there were two innovations in achieving the required fire resistance ratings. The innovative, tiered elevator system was also discussed in Chapter 1. The following sections describe these new technologies. The use of sprayed fire-resistive material is discussed in more detail in Section 5.6.

### **5.4.2 Framed Tube System**

WTC 1 and WTC 2 were among the first steel-structure, high-rise buildings built using the framed-tube concept to provide resistance to lateral (wind) loads. The framed-tube system had previously been used in the concrete-framed, 43-story DeWitt-Chestnut and the 38-story Brunswick buildings, both in Chicago and both completed in 1965.

In the framed-tube concept, the exterior frame system resists the force of the wind. The exterior columns carry a portion of the building gravity loads, and in the absence of wind, are all in compression, i.e., the loads push down on and shorten the columns. Under the effect of a strong wind alone, columns on the windward side are in tension, i.e., they elongate as the top of the building bends away from the wind. The columns on the leeward side are compressed. The columns on the walls parallel to the wind are half in tension (on the windward side) and half in compression (on the leeward side). The net effect of combined gravity and wind loads is larger compression on the leeward side and reduced compression, or in rare instances even tension, on the windward side.

Prior to final design, tests had been performed at the University of Western Ontario to assess the stiffness of the wall panels, which consisted of three columns, each three stories high, and the associated spandrel plates as shown in Figure 1–4. These tests used quarter-scale thermoplastic models of panels planned for the 20<sup>th</sup>, 47<sup>th</sup>, and 74<sup>th</sup> floors. (Recall that the structural members became lighter at the higher floors.) The tests also examined the effect of the spandrel thickness, the width of the box columns, and the presence and thickness of stiffeners. Forces were applied to the models, and the resulting deflections measured. The results of these tests guided the final design of the wall panels and provided support for The Port Authority's acceptance of the resulting structural design. This included the innovations described in Sections 5.4.3 and 5.4.4.

### **5.4.3 Deep Spandrel Plates**

The standard approach to construction of the framed tube would have used spandrel beams or girders to connect the columns. The towers used a band of deep plates as spandrel members to tie the perimeter columns together.

#### 5.4.4 Uniform External Column Geometry

In a typical high-rise building, the columns would have been larger near the base of the building and would have become smaller toward the top as they bore less wind and gravity loads. However, the Yamasaki design called for the appearance of tall, uniform columns (Figure 1–2). This was achieved by varying both the strength of the steels and the thickness of the plates that made up the perimeter columns.

#### 5.4.5 Wind Tunnel Test Data to Establish Wind Loads

To determine the extreme wind speeds that could be expected at the top of the towers, Worthington, Skilling, Helle & Jackson (WSHJ) collected data on the wind speeds and directions recorded in the New York area over the prior 50 years. From these data, a design wind speed for the buildings was determined for a 50 year wind event, defined as the wind speed, averaged over a 20 min duration at 1,500 ft above the ground. The estimated value was just under 100 mph in all directions.

To estimate how the buildings would perform under wind loads, both during construction and upon completion, WSHJ conducted a then unique wind tunnel testing program at Colorado State University (CSU) and the National Physical Laboratory (NPL) in the United Kingdom. In each wind tunnel, a physical model of Lower Manhattan, including the towers, was subjected to steady and turbulent winds consistent with the estimated design wind speeds. The model scale was 1/500 for the CSU tests and 1/400 for the NPL tests. The tower models were thus about 3 ft tall. Separate tests were conducted for the single tower and for the two towers at various spacings, with various values of the tower stiffness and damping, and for various wind directions. The two laboratories obtained similar results. Tests on the two-tower models showed that the wind response of each tower was significantly affected by the presence of the other tower.

WSHJ also conducted experiments to determine the wind-induced conditions that would be tolerated by the people who would work in and visit the towers. Breaking new ground in human perception testing, the investigators found that surprisingly low building accelerations caused discomfort.

The test results led to changes in the building design, including stiffer perimeter columns, and the addition of viscoelastic dampers described in the next section. The dampers were used to reduce the building vibrations due to winds.

#### 5.4.6 Viscoelastic Dampers

The tower design included the first application of damping units to supplement the framed-tube in limiting wind-induced oscillations in a tall building. Each tower had about 10,000 dampers.

On most truss-framed floors (tenant floors), a damper connected the lower chord of a truss to a perimeter column. A depiction of the units is shown in Figure 5–3. On beam-framed floors (generally the mechanical floors with their heavier loads), a damper connected the lower flange of a wide-flange beam (that spanned between the core and the perimeter wall) to a spandrel.

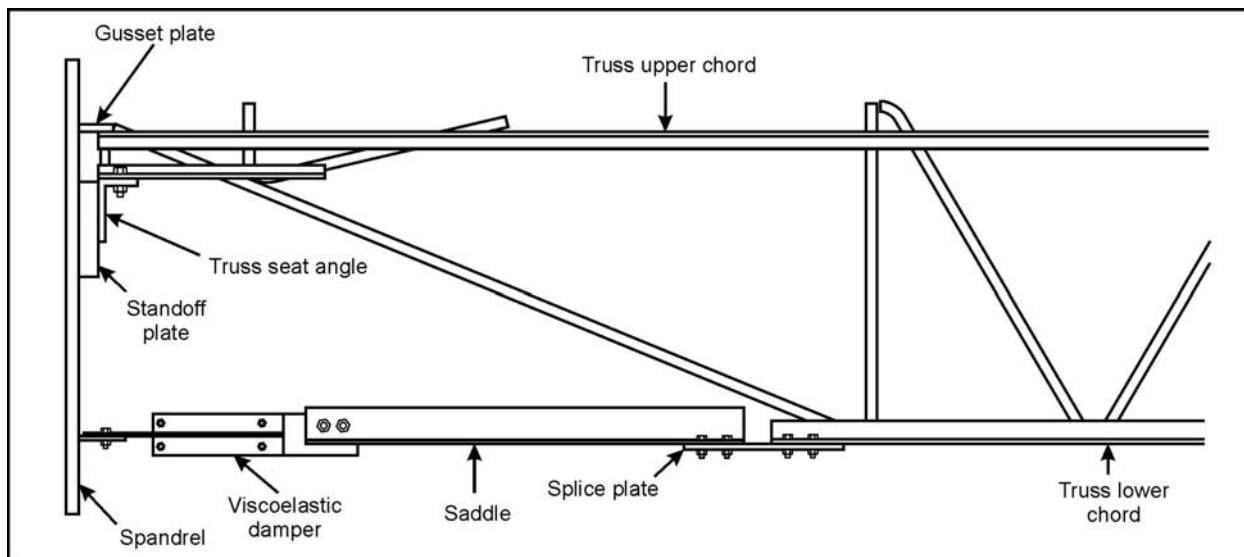

**Figure 5–3. Diagram of floor truss showing viscoelastic damper.**

Two sets of experiments, conducted by the 3M Company (the manufacturer of the viscoelastic material) and by the Massachusetts Institute of Technology, respectively, examined the damping characteristics of the units. Both studies found that the units provided significant supplemental damping under design conditions.

#### 5.4.7 Long-Span Composite Floor Assemblies

The floor system in the towers (as shown in Figure 1–6) was novel in two respects:

- The use of open-web, lightweight steel trusses topped with a slab of lightweight concrete
- The composite action of the steel and concrete that resulted from the “knuckles” of the truss diagonals extending above the top chord and into the poured concrete

Tests conducted in 1964 by Granco Steel Products and Laclede Steel Company (the manufacturer of the trusses for WTC 1 and WTC 2) determined the effectiveness of the knuckles in providing composite action. Another set of tests, performed by Laclede Steel Company, determined that any failure of the knuckles occurred well beyond the design capacity. A third set of tests, performed at Washington University in 1968, confirmed the prior results and indicated that failure was due to crushing of the concrete near the knuckles.

#### 5.4.8 Vertical Shaft Wall Panels

While similar to other gypsum shaft wall systems and firewalls, the compartmentation system used in the vertical shafts (e.g., for elevators, stairs, utilities and ventilation) was unique in that it eliminated the need for any framing. The walls consisted of gypsum planks placed into metal channels at the floor and ceiling slabs. The planks were 2 in. thick (2½ in. on floors with 16 ft ceiling heights) and 16 in. wide, with metal tongue and groove channels attached to the long sides that served as wall studs. An assembled wall was

then covered with gypsum wallboard. The planks were likely custom fabricated for this job, as the investigators found no mention of similar products in gypsum industry literature of the time or since.

## 5.5 STRUCTURAL STEELS

### 5.5.1 Types and Sources

Roughly 200,000 tons of steel were used in the construction of the two WTC towers. The building plans called for an unusually broad array of steel grades and multiple techniques for fabricating the structure from them. The NIST team obtained the information needed to characterize the steels from structural drawings provided by The Port Authority, copies of correspondence during the fabrication stages, steel mill test reports, interviews with fabrication company staff, search of the contemporaneous literature, and measurements of properties at NIST. Sorting through this immense amount of information was made difficult by the large number of fabricators and suppliers, the use of proprietary grades by some of the manufacturers; and the fact that the four fabricators of the impact and fire floor structural elements no longer existed at the time of this Investigation.

Fortunately, the potential for confusion had led the building designers to a tracking system whereby the steel fabricators stamped and/or stenciled each structural element with a unique identifying number. The structural engineering drawings included these identifying numbers as well as the yield strengths of the individual steel components. Thus, when NIST found the identifying number on an element such as a perimeter column panel, the particular steel specified for each component of the element was known, as well as the intended location of the steel in the tower.

In all, 14 grades of steel were specified in the structural engineering plans, having yield strengths from 36 ksi to 100 ksi. Twelve were actually used, as the fabricators were permitted to substitute 100 ksi steel where yield strengths of 85 ksi and 90 ksi were specified. Table 5–1 indicates the elements for which the various grades were used. The higher yield strength steels were used to limit building weight while providing adequate load-carrying capacity.

**Table 5–1. Specified steel grades for various applications.**

Application	Yield Strength (ksi)											
	36	42	45	46	50	55	60	65	70	75	80	100
Perimeter columns	✓	✓	✓	✓	✓	✓	✓	✓	✓	✓	✓	✓
Spandrel plates	✓	✓	✓	✓	✓	✓	✓	✓	✓	✓	✓	✓
Core columns	✓	✓	(a)		(a)							
Floor trusses	✓				✓							

a. About 1 percent of the wide flange core columns were specified to be of these higher grades.

### 5.5.2 Properties

The Port Authority required a thorough and detailed quality assurance programs to ensure compliance with the specifications for the steel, welds, and bolts. The steel data went beyond the minimum yield strength (the property of greatest importance) to include tensile strength and ductility. The quality assurance program included unannounced inspections and confirming tests.

NIST performed confirmatory tests on samples of the 236 pieces of recovered steel to determine if the steel met the structural specifications. Making a definitive assessment was complicated by overlapping specifications from multiple suppliers, differences between the NIST test procedures and the test procedures that originally qualified the steel, the natural variability of steel properties, and damage to the steel from the collapse of the WTC towers. Nonetheless, the NIST investigators were able to determine the following:

- There were 14 grades (strengths) of steel that were specified. However, a total of 32 steels in the impact and fire floors were sufficiently different (grade, supplier, and gage) to require distinct models of mechanical properties.
- The steels in the perimeter columns met their intended specifications for chemistry, mechanical properties, yield strengths, and tensile properties. The steels in the core columns generally met their intended specifications for both chemical and mechanical properties.
- Roughly 13 percent of the measured strength values for the perimeter and core columns were at or below the specified minimums (Figure 5–4). The strength variation was consistent with the historical variability of steel strength and with the effects from damage during the collapse of the towers. The measured values were within the typical design factor of safety.
- The yield strengths of many of the steels in the floor trusses were above 50 ksi, even when they were specified to be 36 ksi.
- Tests on a limited number of recovered bolts showed they were much stronger than expected based on reports from the contemporaneous literature.

The mechanical properties of steel are reduced at elevated temperatures. Based on measurements and examination of published data, NIST determined that a single representation of the elevated temperature effects on steel mechanical properties could be used for all WTC steels. Separate values were used for the yield and tensile strength reduction factors for bolt steels.

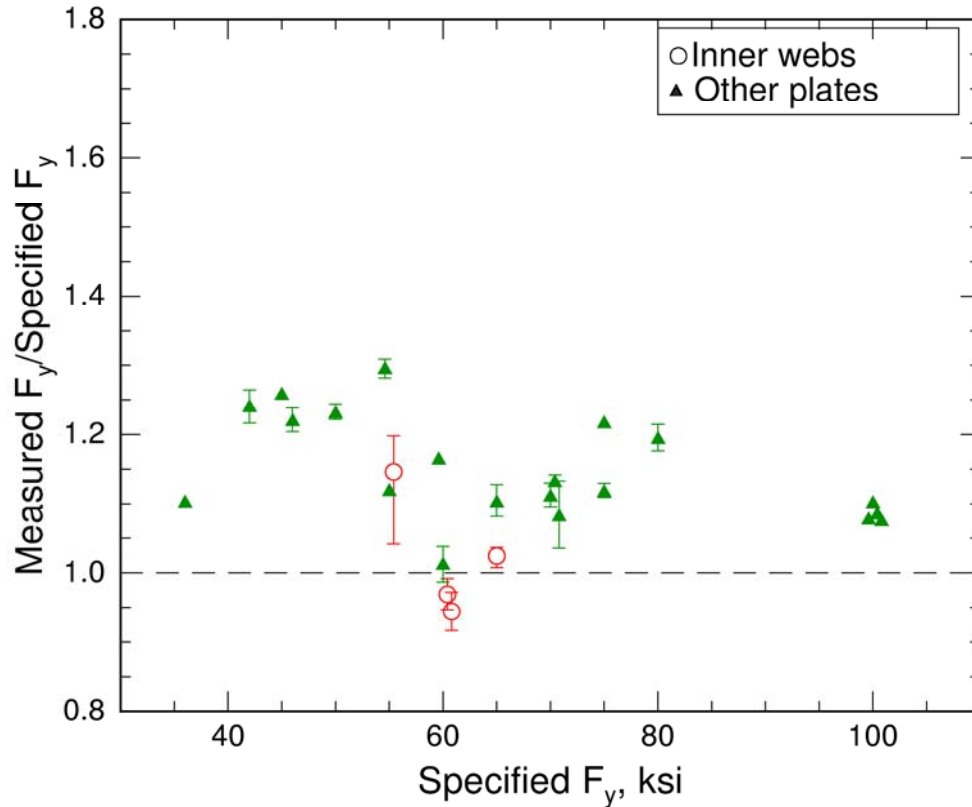

**Note:** The ratio values less than 1 arose from natural variation in the steel and did not affect the safety of the towers on September 11, 2001. The bars represent maximum and minimum values from multiple measurements.

**Figure 5-4. Ratio of measured yield strength ( $F_y$ ) to specified minimum yield strength for steels used in WTC perimeter columns.**

## 5.6 FIRE PROTECTION OF STRUCTURAL STEEL

### 5.6.1 Thermal Insulation

When steel is heated it loses both strength and stiffness. Thus, measures must be taken to protect the steel in a structure from temperature rise (and consequent loss of strength) in case of fire.

Bare structural steel components can heat quickly when exposed to a fire of even moderate intensity. Therefore, some sort of thermal protection, or insulation, is necessary. This insulation can be in direct contact with the steel, such as a sprayed fire-resistive material (SFRM), or can be a fire resistant enclosure surrounding a structural element.

### 5.6.2 Use of Insulation in the WTC Towers

The thermal protection of the steel structures in the WTC towers included a combination of SFRM and enclosures of gypsum wallboard. The use of SFRM for floor truss protection was new in high-rise buildings, and the requirements evolved during the construction and life of the towers. By examining documents supplied by The Port Authority, LERA, and the SFRM manufacturers, NIST was able to

document much of the sequence of these changing requirements and arrive at an estimation of the passive protection in place on September 11, 2001.

## Floor Systems

At the time the WTC was designed, the ASTM E 119 test method had been used for nearly 50 years to determine the fire resistance of structural members and assemblies. However, The Port Authority confirmed to the Investigation Team that there was no record of fire endurance testing of the innovative assemblies representing the thermally protected floor system used in the towers. The floor assembly was not tested despite the fact that the Architect of Record and the Structural Engineer of Record stated that the fire rating of this novel floor system could not be determined without testing.

Prior to construction, the Architect of Record had used information from (unidentified) manufacturers to recommend a 1 in. thickness of SFRM around the top and bottom chords of the trusses and a 2 in. thickness for the web members of the trusses. This was to achieve the fire endurance requirements for Class 1A construction (Section 5.3.3).

In 1969, The Port Authority directed that a ½ in. thick coating of BLAZE-SHIELD Type D (BLAZE-SHIELD D), a mixture of cement and asbestos fibers, be used to insulate the floor trusses. This was to achieve a Class 1A rating, even though the preponderance of evidence suggests that the towers were chosen to be Class 1B, the minimum required by the NYC Building Code. NIST found no evidence of a technical basis for selection of the ½ in. thickness. This coating had been installed as high as the 38<sup>th</sup> floor of WTC 1 when its use was discontinued due to recognition of adverse health effects from inhalation of asbestos fibers. The spraying then proceeded with BLAZE-SHIELD DC/F, a similar product in which the asbestos was replaced by a glassy mineral fiber and whose insulating value was reported by Underwriters Laboratories, Inc., to be slightly better than that of BLAZE-SHIELD D. On the lower floors, the BLAZE-SHIELD D was encapsulated with a sprayed material that provided a hard coat to mitigate the dispersion of asbestos fibers into the air.

In 1994, The Port Authority measured the SFRM thickness on trusses on floors 23 and 24 of WTC 1. In all, average thicknesses were reported for 32 locations, and the overall average thickness was found to be 0.74 in. NIST performed a further evaluation of the SFRM thickness using photographs taken in the 1990s of floor trusses on (non-upgraded) floors 22, 23, and 27 of WTC 1 (Figure 5–5). By measuring dimensions on the photographs, NIST estimated the insulation thicknesses on the diagonal web members of trusses. (The thickness of chord member insulation could not be measured.) The average thickness and standard deviation of web members was 0.6 in. ± 0.3 in. on the main trusses, 0.4 in. ± 0.25 in. on the bridging trusses, and 0.4 in. ± 0.2 in. on the diagonal struts. These numbers indicated that there were areas where the coating thickness was less than the specified 0.5 in.



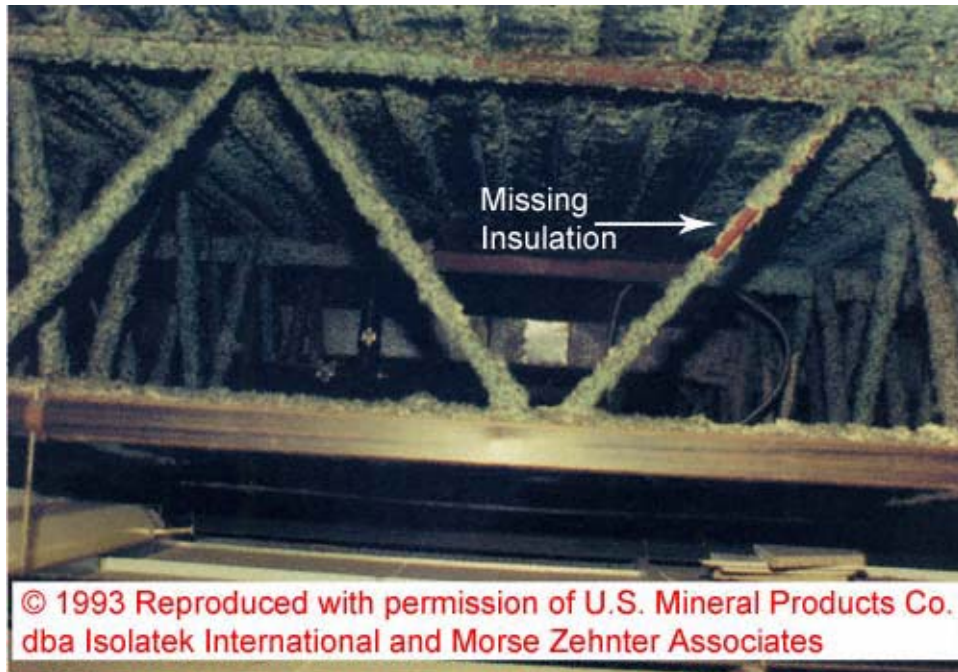

Note: Enhancement by NIST.

**Figure 5–5. Irregularity of coating thickness and gaps in coverage on SFRM-coated bridging trusses.**

In 1995, The Port Authority performed a study to establish requirements for retrofit of sprayed insulation to the floor trusses during major alterations when tenants vacated spaces in the towers. Based on design information for fire ratings of a similar, but not identical, composite floor truss system contained in the Fire Resistance Directory published by Underwriters Laboratories, Inc., the study concluded that a 1½ in. thickness of sprayed mineral fiber material would provide a 2 hour fire rating, consistent with the Class 1B requirements. In 1999, the removal of existing SFRM and the application of new material to this thickness became Port Authority policy for full floors undergoing new construction and renovation. For tenant spaces in which only part of a floor was being modified, the SFRM needed only to be patched to ¾ in. thickness or to match the 1½ in. thickness, if it had previously been upgraded. In the years between 1995 and 2001, thermal protection was upgraded on 18 floors of WTC 1, including those on which the major fires occurred on September 11, 2001, and 13 floors of WTC 2 that did not include the fire floors. The Port Authority reported that the insulation used in the renovations was BLAZE-SHIELD II.

In July 2000, an engineering consultant to The Port Authority issued a report on the requirements of the fire resistance of the floor system of the towers. Based on calculations and risk assessment, the consultant concluded that the structural design had sufficient inherent fire performance to ensure that the fire condition was never the critical condition with respect to loading allowances. The report recommended that a 1.3 in. thickness be used for the floor trusses.

In December 2000, another condition assessment concluded that the structural insulation in the towers had an adequate 1 hour rating, considering that all floors were now fitted with sprinklers. The report also noted the ongoing Port Authority program to upgrade the fire-resistive material thickness to 1½ in. in order to achieve a 2 hour fire rating.

The Port Authority provided NIST with the records of measurements of SFRM thickness on upgraded floors in both towers. The average thickness and standard deviation on the main trusses was 2.5 in.  $\pm$  0.6 in., based on 18 data sets with a total of 256 measurements. NIST analysis of several Port Authority photographs from the 1990s of the upgraded 31<sup>st</sup> floor of WTC 1 indicated an average thickness and standard deviation on the main trusses of 1.7 in.  $\pm$  0.4 in., based on 52 measurements from five web members in two photographs. NIST gave more weight to the measured data, which were taken according to a standard procedure in ASTM E 605, than to the data scaled from photographs, for which there was neither standard procedure nor calibration of the method.

## Perimeter Columns

In 1966, the contractor responsible for insulating the perimeter columns proposed applying a 1 3/16 in. thick coating of BLAZE-SHIELD D to the three external faces (Figure 5–6) to achieve a 4 hour rating, which is a Class 1A rating requirement (1 hour more than Class 1B). NIST found evidence of a technical basis for this decision. In the construction drawings prepared by the exterior cladding contractor, the following SFRM thicknesses were specified:

- 7/8 in. of vermiculite plaster on the interior face and 1 3/16 in. of BLAZE-SHIELD D on the other three faces.
- 1/2 in. of vermiculite plaster on the interior surfaces of the spandrels and 1/2 in. of BLAZE-SHIELD D on the exterior surfaces.

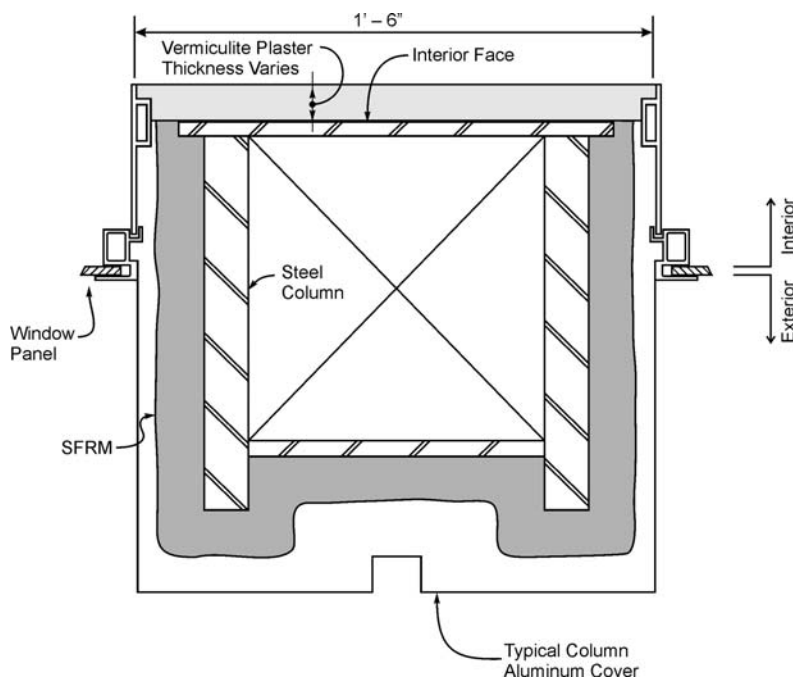

**Figure 5–6. Thermal insulation for perimeter columns.**

Vermiculite plaster had a higher thermal conductivity and thereby increased heat migration from the room air to the column steel and, thus, could keep the steel temperature at 70 °F when the temperature was 0 °F outside.

In October 1969, The Port Authority provided the following instructions to the contractor applying the sprayed fire protection, in order to maintain the Class 1-A Fire Rating of the NYC Building Code:

- 2 3/16 in. of BLAZE-SHIELD D for columns smaller than 14WF228<sup>12</sup> and 1 3/16 in. for columns equal to or greater than 14WF228.
- ½ in. covering of BLAZE-SHIELD D for beams, spandrels and bar joists.

NIST's review of available documents has not uncovered the reasons for selecting BLAZE-SHIELD fire-resistive material or the technical basis for specifying ½ in. thickness of SFRM for the floor trusses. As with the trusses, BLAZE-SHIELD DC/F was applied to the perimeter columns above the 38<sup>th</sup> floor of WTC 1 and all the perimeter columns in WTC 2.

### Core Columns and Beams

Multiple approaches were used to insulate structural elements in the core:

- Those core columns located in rentable and public spaces, closets, and mechanical shafts were enclosed in boxes of gypsum wallboard (and thus were inaccessible for inspection). The amount of the gypsum enclosure in contact with the column varied depending on the location of the column within the core. SFRM (BLAZE-SHIELD D and DC/F) was applied on those faces that were not protected by the gypsum enclosure. The thicknesses specified in the construction documents were 1 3/16 in. for the heavier columns and 2 3/16 in. for the lighter columns.
- Columns located at the elevator shafts were protected using the same SFRM thicknesses. They were not enclosed and thus were accessible for routine inspections.

Inspection of the columns within the elevator shaft spaces in 1993 indicated some loss of SFRM coverage. As a result, new insulation was applied to selected columns within the elevator shaft space. Information provided to NIST indicated that a different SFRM, Monokote Type 2-106, was used. Thickness measurements for columns and beams below the 45<sup>th</sup> floor indicated average thicknesses of 0.82 in. and 0.97 in., respectively. Information from The Port Authority indicated that the minimum required thickness of the re-applied SFRM was ½ in. for the columns and ¾ in. for the beams.

NIST was unable to locate information from which to characterize the insulation of the core columns and beams that were not accessible. Except as noted above, once completed, the core was generally not inspected. NIST was not able to locate any post-collapse core beams or columns with sufficient insulation still attached to make pre-collapse thickness measurements.

### Summary of SFRM on September 11, 2001

Table 5–2 summarizes the types and thicknesses of the SFRMs used in the towers. According to Port Authority documents, in the upper part of the towers, trusses on floors 92 through 100 and 102 in WTC 1

---

<sup>12</sup> This designation indicates that the column is a 14 in. deep wide flange section and weighs 228 pounds per foot.

had upgraded insulation by September 11, 2001. In WTC 2, truss insulation had been upgraded on floors 77, 78, 85, 88, 89, 92, 96, 97, and 99.

**Table 5–2. Types and locations of SFRM on fire floors.**

Building Component	Material	Thickness (in.)		
		Specified <sup>a</sup>	Installed	Used in Analysis <sup>b</sup>
<b>FLOOR SYSTEM</b>				
<b>Original</b>				
Main trusses and diagonal struts	BLAZE-SHIELD DC/F	0.5	0.75	0.6
Bridging trusses (one-way zone) <sup>c</sup>	BLAZE-SHIELD DC/F	0.5	0.38 <sup>d</sup>	0.3
Bridging trusses (two-way zone) <sup>c</sup>	BLAZE-SHIELD DC/F	0.5	0.38 <sup>d</sup>	0.6
<b>Upgraded</b>				
Main trusses	BLAZE-SHIELD II	1.5	2.5	2.2
Main truss diagonal struts	BLAZE-SHIELD II	1.5	2.5	2.2
Bridging trusses	BLAZE-SHIELD II	1.5	2.5	2.2
<b>EXTERIOR WALL PANEL</b>				
Box columns				
Exterior face	BLAZE-SHIELD DC/F	1 3/16	(e)	1.2
Interior face	Vermiculite plaster	7/8	(e)	0.8
Spandrels				
Exterior face	BLAZE-SHIELD DC/F	0.5	(e)	0.5
Interior face	Vermiculite plaster	0.5	(e)	0.5
<b>CORE COLUMNS</b>				
Wide flange columns				
Light	BLAZE-SHIELD DC/F	2 3/16	(e)	2.2
Heavy	BLAZE-SHIELD DC/F	1 3/16	(e)	1.2
Box columns				
Light	BLAZE-SHIELD DC/F	(f)	(e)	2.2 <sup>(g)</sup>
Heavy	BLAZE-SHIELD DC/F	(f)	(e)	1.2 <sup>(g)</sup>
<b>CORE BEAMS</b>				
	BLAZE-SHIELD DC/F	0.5	(e)	0.5

a. "Specified" means material and thicknesses determined from correspondence among various parties.

b. The analysis is described in Chapter 6.

c. Not expressly specified. SFRM was required for the areas where the main trusses ran in both directions and, while not required, was also applied in the areas where they ran in one direction only.

d. Analysis of photographs indicated that the thickness was approximately one half that on the main trusses.

e. Not able to determine.

f. Not specified.

g. Thickness assumed equal to wide flange columns of comparable weight per foot.

## 5.7 CONCRETE

Two types of concrete were used for the floors of the WTC towers: lightweight concrete in the tenant office areas and normal weight concrete in the core area. Because of differences in composition and weight, the two types of concrete respond differently to elevated temperatures, as shown in Figure 5–7. While their tensile strengths degrade identically, lightweight concrete retains more of its compressive strength at higher temperatures. The degradation of concrete mechanical properties with temperature was included in the structural response analysis of the floor systems.

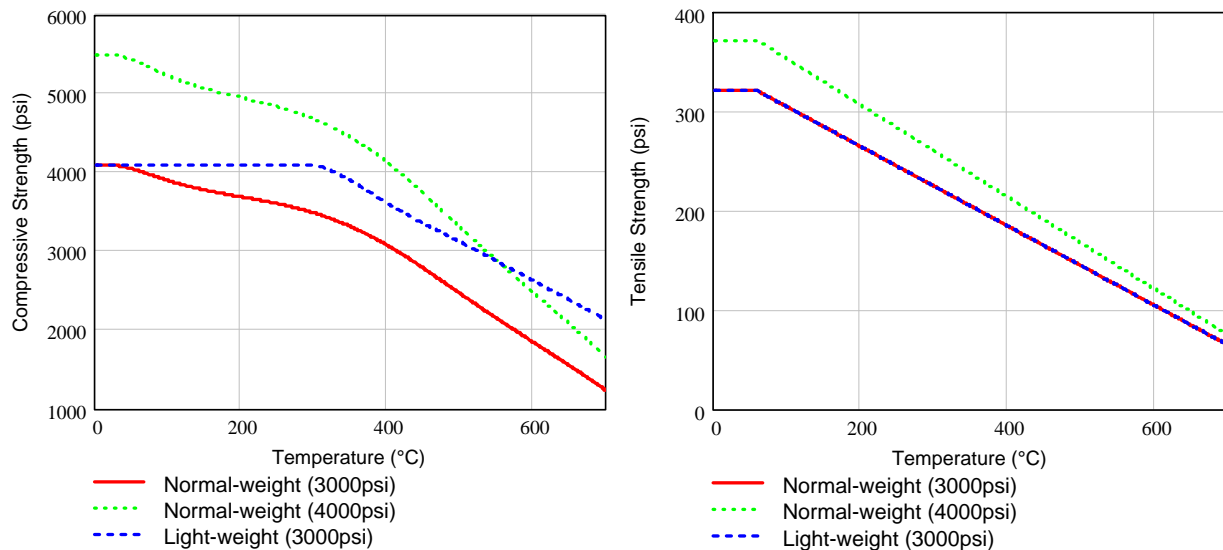

Figure 5–7. Temperature–dependent concrete properties.

## 5.8 THE TENANT SPACES

### 5.8.1 General

About 80 percent of the floors had a single tenant. Many of these floors were filled with arrays of modular office cubicles, their low partitions affording sightlines to the windows, with perhaps an occasional perimeter conference room or executive office in the way (Figure 1–11). Trading floors (Figure 1–12) had tables and computers throughout and food service areas to minimize time away from the non-stop transactions. The remaining 20 percent of the floors were each subdivided among as many as 25 tenants. Some of the approximately 25 tenants that occupied two or more contiguous floors installed convenience stairways within their own space.

Certain floors were of special interest to the Investigation. These were the floors on which there was structural damage from the aircraft and/or on which extensive fires were observed. These floors, designated as focus floors, and the information NIST obtained regarding them are characterized in Table 5–3. Additional information, obtained from the tenant firms and The Port Authority, is summarized in the remainder of this chapter.

## 5.8.2 Walls

The plans for the tenant spaces in WTC 1 showed no interior walls whose sole function was to subdivide the floors. There were a number of partitioned offices and conference areas. Although NIST was not able to obtain layout drawings for the fire floors in WTC 2, the verbal descriptions of those floors indicated similarly open space. The types of interior walls were described in Section 5.3.4.

## 5.8.3 Flooring

Truss-supported concrete slabs formed the floors in the office areas of the towers. Some tenants had installed slightly raised (6 in.) floors on top of the slab under which communication cables were run. This was especially true on trading floors. There was a wide range of floor coverings in use. Inlaid wood and marble were used in some reception areas. Most commonly, the expanse of the floor was covered with nylon carpet.

## 5.8.4 Ceilings

There were two different ceiling tile systems originally installed in the towers under Port Authority specification. The framing for each was hung from the bottom of the floor trusses, resulting in an apparent room height of 8.6 ft and an above-ceiling height of about 3.4 ft. The tiles in the tenant spaces were 20 in. square,  $\frac{3}{4}$  in. thick, lay-in pieces on an exposed tee bar grid system. The tiles in the core area were 12 in. square,  $\frac{3}{4}$  in. thick, mounted in a concealed suspension system. Neither system was specified to be fire-rated, and it was estimated that in a fire they might provide only 10 min to 15 min of thermal protection to the trusses before the ceiling frame distorted and the tiles fell. Chemically, the tiles were similar, and their combustible content, flame spread, and smoke production were all quite low.

## 5.8.5 Furnishings

The decorating styles of the tower tenants ranged from simple, modular trading floors to customized office spaces. The most common layout of the focus floors was a continuous open space populated by a large array of workstations or cubicles (Figure 1–11). The number of different types of workstations in the two towers was probably large. However, discussions with office furniture distributors and visits to showrooms indicated that, while there was a broad range of prices and appearances, the cubicles were fundamentally similar to that shown in Figure 5–8.

The workstations were typically 8 ft square, bounded on all four sides by privacy panels, with an entrance opening in one side only. Within the area defined by the panels was a



**Source:** Reproduced with permission of The Port Authority of New York and New Jersey.

**Figure 5–8. A WTC workstation.**

self-contained workspace: desktop (almost always a wood product, generally with a laminated finish), file storage, bookshelves, carpeting, chair, etc. Presumably there were a variety of amounts and locations of paper, both exposed on the work surfaces and contained within the file cabinets and bookshelves. The cubicles were grouped in clusters or rows, with up to 215 units on a given floor.

NIST estimated the combustible fuel loading on these floors to have been about 4 lb/ft<sup>2</sup> (20 kg/m<sup>2</sup>), or about 60 tons per floor. This was somewhat lower than found in prior surveys of office spaces. The small number of interior walls, and thus the minimal amount of combustible interior finish, and the limited bookshelf space account for much of the differences. While paper in the filing cabinets might have been significant in mass, it did not burn readily due to the limited oxygen available within the drawers.

Table 5–3. Floors of focus.

Building	Floor	Tenant	Damage <sup>a</sup>	Fires <sup>b</sup>	Material Obtained <sup>c</sup>	General Description of Tenant Layout
WTC 1	92	Carr Futures, empty		Y	FP (Carr), V	
	93	Marsh & McLennan (M&M), Fred Alger Mgmt.	Y	Y	FP, F, V	M&M occupied the south side. Filled with workstations. Demising walls for the south façade to the edges of the core. Offices along the east side of the south core wall. Stairwell to the 94 <sup>th</sup> floor.
	94	Marsh & McLennan	Y	Y	FP, F, V	Generally open space filled with workstations. Offices and conference rooms around most of the perimeter. Stairwell to the 93 <sup>rd</sup> floor.
	95	Marsh & McLennan	Y	Y	FP, F, V	Generally open space filled with workstations. Offices, conferences and work areas in exterior corners. Large walled data center along north and east sides. Two separate stairwells, one to 94 <sup>th</sup> floor, the other to the 96 <sup>th</sup> and 97 <sup>th</sup> floors.
	96	Marsh & McLennan	Y	Y	FP, F, V	Generally open space filled with workstations. Offices at exterior corners and middle of north and south facades. Some conference rooms on north and south sides of core. Stairwell connection to 95 <sup>th</sup> and 97 <sup>th</sup> floors.
	97	Marsh & McLennan	Y	Y	FP, F, V	Generally open space filled with workstations. Offices at exterior corners and in the middle of the north façade. Two separate stairwells: one connected to the 95 <sup>th</sup> and 96 <sup>th</sup> floors, the other connected to the 98 <sup>th</sup> , 99 <sup>th</sup> , and 100 <sup>th</sup> floors.
	98	Marsh & McLennan	Y	Y	FP, F, V	Generally open space filled with workstations. Offices at exterior corners and middle of north and south facades. Some conference rooms on north and south sides of core. Stairwell connected to the 97 <sup>th</sup> , 99 <sup>th</sup> , and 100 <sup>th</sup> floors.
	99	Marsh & McLennan	Y	Y	FP, F, V	Open space filled with workstations on the east side and east half of the north side. Offices at exterior corners and along south and west sides. Large walled area on west side of north façade. Stairwell connected to the 97 <sup>th</sup> , 98 <sup>th</sup> , and 100 <sup>th</sup> floors.
	100	Marsh & McLennan		Y	FP, F, V	Considerable number of workstations, but more individual offices than the other floors. Partitioned offices extended the full length of the west wall and also at other locations along walls and at exterior corners. Stairway connected to the 97 <sup>th</sup> , 98 <sup>th</sup> , and 99 <sup>th</sup> floors.
104	Cantor Fitzgerald		Y	V	Trading floor. Tables with many monitors.	



Building	Floor	Tenant	Damage <sup>a</sup>	Fires <sup>b</sup>	Material Obtained <sup>c</sup>	General Description of Tenant Layout
WTC 2	77	Baseline	Y	Y	FP, V	Generally open space. Offices along east and west core walls. A few offices in each exterior corner of the floor.
	78	Baseline, 1 <sup>st</sup> Commercial Bank	Y	Y	FP, V	West side open. Northeast quadrant walled. Offices along south side of east core wall. Offices along east side of south façade.
	79	Fuji Bank	Y	Y	V	
	80	Fuji Bank	Y	Y	FP, V	Generally open space filled with workstations. Offices or conference rooms at exterior corners and along south half of west façade. Large vault at southeast corner of core.
	81	Fuji Bank	Y	Y	V	
	82	Fuji Bank	Y	Y	V	
	83	Chuo Mitsui, IQ Financial	Y		V	Chuo Mitsui had half the area. Wide open space. No information regarding IQ Financial.
	84	Eurobrokers	Y		V	Open floor for trading. Tables rather than workstations. Perimeter offices.
	85	Harris Beach	Y		FP, V	Offices around full perimeter. Offices along east, west and south walls of core.

- a. Floors on which the exterior photographs indicated direct damage from the aircraft.
- b. Floors on which the exterior photographs indicated extensive or sustained fires.
- c. Types of descriptive material obtained: FP, floor plan; F, documentation of furnishings; V, verbal description of interior.

This page intentionally left blank.

## Chapter 6

# RECONSTRUCTION OF THE COLLAPSES

---

### 6.1 APPROACH

The following presents an overview of the methods used to reach the accounts in Part I. The details may be found in the companion reports to this document, which are indexed in Appendix C.

A substantial effort was directed at establishing the baseline performance of the WTC towers, i.e., estimating the expected performance of the towers under normal design loads and conditions. This enabled meeting the third objective of the Investigation, as listed in the Preface to this report. The baseline performance analysis also helped to estimate the ability of the towers to withstand the unexpected events of September 11, 2001. Establishing the baseline performance of the towers began with the compilation and analysis of the procedures and practices used in the design, construction, operation, and maintenance of the structural, fire protection, and egress systems of the WTC towers. The additional components of the performance analysis were:

- The standard fire resistance of the WTC truss-framed floor system,
- The quality and properties of the structural steels used in the towers, and
- The response of the WTC towers to design gravity and wind loads.

The second substantial effort was the simulation of the behavior of each tower on September 11, 2001, providing the basis for meeting the first and second objectives of the Investigation. This entailed four modeling steps:

1. The aircraft impact into the tower, the resulting distribution of jet fuel, and the damage to the structure, partitions, insulation materials, and building contents.
2. The spread of the multi-floor fires.
3. The heating of the structural elements by the fires.
4. The response of the damaged and heated building structure, and the progression of structural component failures leading to the initiation of the collapse of the towers.

For such complex structures and complex thermal and structural processes, each of these steps stretched the state of the technology and tested the limits of software tools and computer hardware. For example, the investigators advanced the state-of-the-art in the measurement of construction material properties and in structural finite element modeling. New modeling capability was developed for the mapping of fire-generated environmental temperatures onto the building structural components.

For the final analyses, four cases were used, each involving all four of the modeling steps. Case A and Case B were for WTC 1, with Case B generally involving more severe impact and fire conditions than

Case A. For WTC 2, Case D involved more severe impact and fire conditions than Case C. The results of the two cases for each tower provided some understanding of the uncertainties in the predictions.

There were substantial uncertainties in the as-built condition of the towers, the interior layout and furnishings, the aircraft impact, the internal damage to the towers (especially the insulation), the redistribution of the combustibles, and the response of the building structural components to the heat from the fires. To increase confidence in the simulation results, NIST used information from an extensive collection of photographs and videos of the disaster, eyewitness accounts from inside and outside the buildings, and laboratory tests involving large fires and the heating of structural components. Further, NIST applied formal statistical methods to identify those parameters that had the greatest effect on the model output. These key inputs were then varied to determine whether the results were reasonably robust.

The combined knowledge from all the gathered data and analyses led to the development of a probable collapse sequence for each tower,<sup>13</sup> the identification of factors that contributed to the collapses, and a list of factors that could have improved building performance or otherwise mitigated the loss of life.

## **6.2 DEVELOPMENT OF THE DISASTER TIMELINE**

Time was the unifying factor in combining photographic and video information, survivor accounts, emergency calls from within the towers, and communications among emergency responders. The visual evidence was the most abundant and the most detailed.

The destruction of the WTC towers was the most heavily photographed disaster in history. The terrorist attacks occurred in an area that is the national home base of several news organizations and has several major newspapers. New York City is also a major tourist destination, and visitors often carry cameras to record their visits. Further, the very height that made the towers accessible to the approaching aircraft also made them visible to photographers. As a result there were hundreds of both professional and amateur photographers and videographers present, many equipped with excellent equipment and the knowledge to use it. These people were in the immediate area, as well as at other locations in New York and New Jersey.

There was a surprisingly large amount of photographic material shot early, when only WTC 1 was damaged. By the time WTC 2 was struck, the number of cameras and the diversity of locations had increased. Following the collapse of WTC 2, the amount of visual material decreased markedly as people rushed to escape the area and the huge dust clouds generated by the collapse obscured the site. There is a substantial, but less complete, amount of material covering the period from the tower collapses to the collapse of WTC 7 late the same afternoon.

---

<sup>13</sup> The focus of the Investigation was on the sequence of events from the instant of aircraft impact to the initiation of collapse for each tower. For brevity in this report, this sequence is referred to as the “probable collapse sequence,” although it does not actually include the structural behavior of the tower after the conditions for collapse initiation were reached and collapse became inevitable.

There were multiple sources of visual material:

- Recordings of newscasts from September 11 and afterward, documentaries, and other coverage provided information and also pointed toward other potential sources of material.
- Web sites of the major photographic clearinghouses.
- Local print media.
- NYPD and FDNY.
- Collections of visual material assembled for charitable or historical purposes.
- Individuals' photographs and videos that began appearing on the World Wide Web as early as September 11, 2001.
- Responses to public appeals for visual material by the Investigation Team.

Investigation staff contacted each of the sources, requested the material, made arrangements for its transfer, and addressed copyright and privacy issues. Emphasis was placed on obtaining material in a form as close as possible to the original in order to maintain as much spatial and timing information as possible: direct digital copies of digital photographs and videos, high resolution digitized copies of film or slide photographs, and direct copies from the original source of analog video.

The assembled collection included:

- 6,977 segments of video footage, totaling in excess of 300 hours. The media videos included both broadcast material and outtakes. Additionally, NIST received videotapes recorded by more than 20 individuals.
- 6,899 photographs from at least 200 photographers. As with the videos, many of the photographs were unpublished.

This vast amount of visual material was organized into a searchable database in which each frame was characterized by a set of attributes: photographer (name and location), time of shot/video, copyright status, content (including building, face(s), key events (plane strike, fireballs, collapse), the presence of FDNY or NYPD people or apparatus, and other details, such as falling debris, people, and building damage).

The development of a timeline for fire growth and structural changes in the WTC buildings required the assignment of times of known accuracy to each video frame and photograph. Images were timed to a single well-defined event. Due to the large number of different views available, the chosen event was the moment the second plane struck WTC 2, established from the time stamps in the September 11 telecasts. Based on four such video recordings, the time of the second plane impact was established as 9:02:59 a.m.

The TV network clocks were quite close to the actual time since they were regularly updated from highly accurate geopositioning satellites or the precise atomic-clock-based timing signals provided by NIST as a public service.

Absolute times were then assigned to all frames of all videos that showed the second plane strike. By matching photographs and other videos to specific events in these initially assigned videos, the time assignments were extended to visual materials that did not include the primary event. Times were also cross-matched using additional characteristics, such as the appearance and locations of smoke and fire plumes, distinct shadows cast on the buildings by these plumes, the occurrence of well-defined events such as a falling object, and even a clock being recorded in an image. By such a process, it was possible to place photographs and videos extending over the entire day on a single timeline. As the time was assigned to a particular photograph or video, the uncertainty in the assignment was also logged into the database. In all, 3,032 of the catalogued photographs and 2,673 of the video clips in the databases were timed with accuracies of  $\pm 3$  s or better.

This process enabled establishing the times of four major events of September 11, listed in Table 6–1. The building collapse times were defined to be the point in time when the entire building was first observed to start to collapse.

**Table 6–1. Times for major events on September 11, 2001.**

Event	Time
First Aircraft Strike	8:46:30 a.m.
Second Aircraft Strike	9:02:59 a.m.
Collapse of WTC 2	9:58:59 a.m.
Collapse of WTC 1	10:28:22 a.m.

There were additional sources of timed information. Phone calls from people within the building to relatives, friends, and 9-1-1 operators conveyed observations of the structural damage and developing hazards. Communications among the emergency responders and from the building fire command centers contributed further information about the areas where the external photographers had no access.

### 6.3 LEARNING FROM THE VISUAL IMAGES

The photographic and video images were rich sources of information on the condition of the buildings following the aircraft impact, the evolution of the fires, and the deterioration of the structure. To enable analysis of this information, a shorthand notation (based on the building design drawings) was used to label the exterior columns and windows of the buildings:

- First, the faces of the towers were numbered in a manner identical to those used in the original plans:

WTC 1:	north: 1	east: 2	south: 3	west: 4
WTC 2:	west: 1	north: 2	east: 3	south: 4

- The 59 columns across each tower face were assigned three-digit numbers. Following the floor number, the first digit was that of the face, and the remaining two digits were assigned consecutively from right to left as viewed from outside the building. Thus, the fourth column from the right on the east face of the 81<sup>st</sup> floor of WTC 1 was labeled 81-204.

- Each of the 58 windows on each floor and tower face was assigned the number of the column to its right as viewed from the outside of the building and was also identified by its floor. Thus the rightmost window on the east face of the 94<sup>th</sup> floor of WTC 1 was labeled 94-201.

As an example of information that was extracted, Figure 6–1 shows an enhanced image of the east face of WTC 2. Figure 6–2 expands a section of interest. The amount of detail available is evident. For instance, large piles of debris are present on the north side of the tower on the 80<sup>th</sup> and 81<sup>st</sup> floors, and locations where fires are visible or where missing windows are easily identified. Many details of each frame were important in tracking the evolution of the fires and the damage to the buildings.

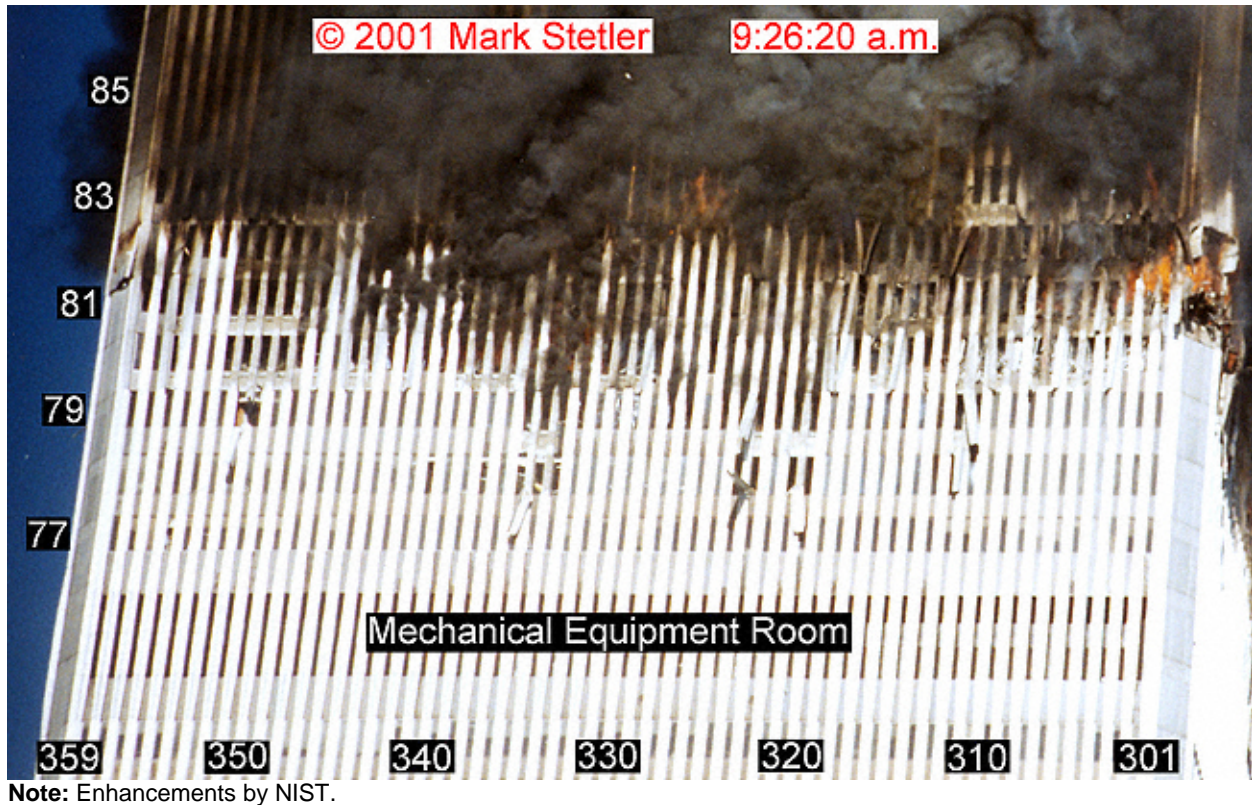

**Figure 6–1. 9:26:20 a.m. showing the east face of WTC 2.**

In each photograph and each video frame, each window was also coded to indicate whether the window was still in place or not and the extent to which flames and smoke were visible. Color-coded graphics of the four façades of the two towers were then constructed. Examples of these graphics were shown in Chapters 2 and 3.

The results of the visual analysis included:

- The locations of the broken windows, providing information on the source of air to feed the fires within.
- Observations of the spread of fires.
- Documentation of the location of exterior damage from the aircraft impact and subsequent structural changes in the buildings.



Note: Enhancements by NIST.

Figure 6–2. Close-up of section of Figure 6–1.

- Identification of the presence or absence of significant floor deterioration at the building perimeter.
- Observations of certain actions by building occupants, such as breaking windows.

The near-continuous observations of the externally visible fires provided input to the computer simulations of fire growth and spread. The discrete observations of changes in the displacement of columns and, to a far lesser degree, floors became validation data for the modeling of the approach to structural collapse of the towers. Table 6–2 lists the most important observations.

## 6.4 LEARNING FROM THE RECOVERED STEEL

### 6.4.1 Collection of Recovered Steel

NIST had two reasons for obtaining specimens of structural steel from the collapsed towers. The primary objective was characterizing the quality of the steel and determining its properties for use in the structural modeling and analysis of the collapse sequences. The second reason was obtaining information regarding the behavior of the steel in the aircraft impact zone and in areas which had major fires.



**Table 6–2. Indications of major structural changes up to collapse initiation.**

<b>Tower</b>	<b>Time (a.m.)</b>	<b>Observation</b>
WTC 1	10:18	Smoke suddenly expelled on the north face (floors 92, 94, 95 to 98) and west face (92, 94 to 98).
	10:23	Inward bowing of perimeter columns on the east side of the south face from floors 94 to 100; maximum extent: 55 in. ± 6 in. at floor 97.
	10:28:22	First exterior sign of collapse (downward movement of building exterior). Tilting of the building section above the impact and fire area to due south as the structural collapse initiated. First exterior sign of downward movement of building at floor 98.
WTC 2	9:02:59	Exterior fireball from the east face of floor 82 and from the north face from floors 79 to 82. The deflagration prior to the fireballs may have caused a significant pressure pulse to act on floors above and below.
	9:21	Inward bowing of exterior wall columns on most of the east face from floors 78 to 83; maximum extent: 7 in. to 9 in. at floor 80.
	9:58:59	First exterior sign of collapse (downward movement of building exterior). The northeast corner tilted counterclockwise around the base of floor 82. Column buckling was then seen progressing across the north face and nearly simultaneously on the east face. Tilting of the building section above the impact and fire area to the east and south prior to significant downward movement of the upper building section. The tilt to the south did not increase any further as the upper building section began to fall, but the tilt to the east did increase until dust clouds obscured the view.

Within weeks of the destruction of the WTC, contractors of New York City had begun cutting up and removing the debris from the site. Members of the FEMA-sponsored and ASCE-led Building Performance Assessment Team, members of the Structural Engineers Association of New York, and Professor A. Astaneh-Asl of the University of California, Berkeley, CA, with support from the National Science Foundation, had begun work to identify and collect WTC structural steel from various recycling yards where the steel was taken during the clean-up effort. The Port Authority of New York and New Jersey (Port Authority) also collected structural steel elements for future exhibits and memorials.

Over a period of about 18 months, 236 pieces of steel were shipped to the NIST campus, starting about six months before NIST launched its Investigation. These samples ranged in size and complexity from a nearly complete three-column, three-floor perimeter assembly to bolts and small fragments. Figures 6–3 through 6–5 show some of the recovered steel pieces. Seven of the pieces were from WTC 5. The remaining 229 samples represented roughly 0.25 percent to 0.5 percent of the 200,000 tons of structural steel used in the construction of the two towers.

The collection at NIST included samples of all the steel strength levels specified for the construction of the towers. The locations of all structural steel pieces in WTC 1 and WTC 2 were uniquely identified by stampings (recessed letters and numbers) and/or painted stencils. NIST was successful in finding and deciphering these identification markings on many of the perimeter panel sections and core columns, in many cases using metallurgical characterization to complete missing identifiers. In all, 42 exterior panels were positively identified: 26 from WTC 1 and 16 from WTC 2. Twelve core columns were positively identified: eight from WTC 1 and four from WTC 2. Twenty-three pieces were identified as being parts of trusses, although it was not possible to identify their locations within the buildings.

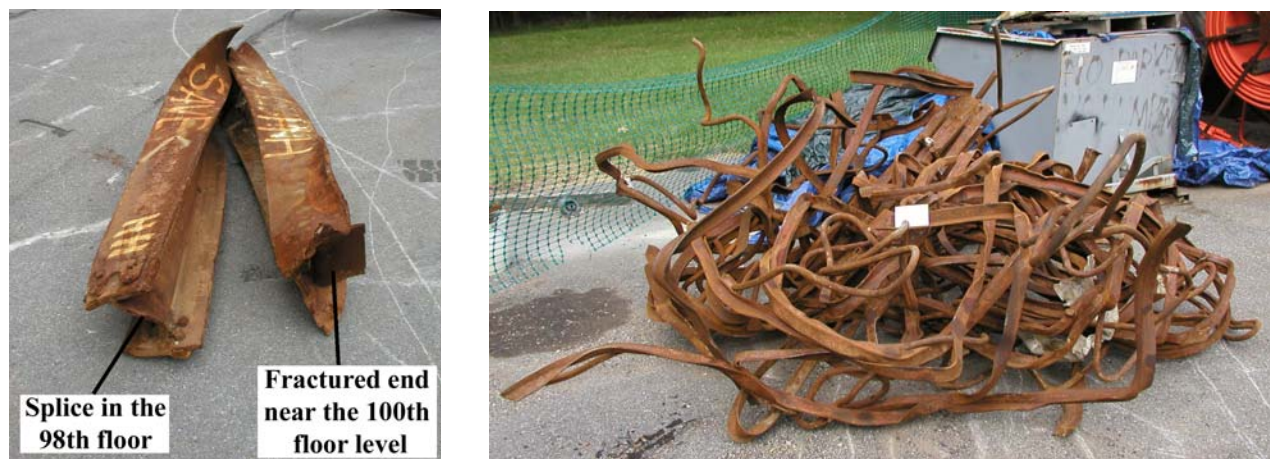

Source: NIST.

**Figure 6–3. Examples of a WTC 1 core column (left) and truss material (right).**



Source: NIST.

**Figure 6–4. WTC 1 exterior panel hit by the fuselage of the aircraft.**

Overlaying the locations of the specimens with photographs of the building exteriors following the aircraft impact (for perimeter columns and spandrels) and the extent-of-damage estimates (Section 6.8) (for core columns) enabled the identification of steel pieces near the impact zones. These included five specimens of exterior panels from WTC 1 and two specimens of core columns from each of the towers.

#### **6.4.2 Mechanical and Physical Properties**

NIST determined the properties of many of the recovered pieces for comparison with the original purchase requirements, comparison with the quality of steel from the WTC construction era, and input to the structural models used in the Investigation. Structural steel literature and producers' documents were used to establish a statistical basis for the variability expected in steel properties.

The properties of the steel samples tested were consistent with the specifications called for in the steel contracts. In particular, the yield strengths of all samples of the floor trusses were higher than called for in the original specifications. This was in part because the truss steels were supplied as a higher grade than specified. Overall, approximately 87 percent of all perimeter and core column steel tested exceeded the required minimum yield strengths specified in design documents. Test data for the remaining samples were below specifications, but were within the expected variability and did not affect the safety of the towers on September 11, 2001. Furthermore, lower strength values measured by NIST could be expected due to (a) differences in test procedures from those used in the qualifying mill tests and (b) the damaged state of the samples. The values of other steel properties were similar to typical construction steels of the WTC construction era. The limited tests on bolts indicated that their strengths were greater than the specified minimum, and they were stronger than contemporaneous literature would suggest as typical. The tested welds performed as expected.

NIST measured the stress-strain behavior at room temperature (for modeling baseline performance), high temperature strength (for modeling structural response to fire), and at high strain rates (for modeling the aircraft impact). Based on data from published sources, NIST estimated the thermal properties of the steels (specific heat, thermal conductivity, and coefficient of thermal expansion) and creep behavior for use in the structural modeling of the towers' response to fire.

### 6.4.3 Damage Analysis

NIST performed extensive analyses of the recovered steel specimens to determine their damage characteristics, failure modes, and (for those near the fire zones) fire-related degradation. In some cases, assessment of enhanced photographic and video images of the towers enabled distinguishing between damage that occurred prior to the collapse and damage that occurred as a result of the collapse. Because the only visual evidence was from the outside of the buildings, this differentiation was only possible for the perimeter panel sections. The observations of fracture and failure behavior, confirmed by an Investigation contractor, were also used to guide the modeling of the towers' performance during impact and subsequent fires and to evaluate the model output.



Source: NIST.

**Figure 6–5. WTC 1 exterior panel hit by the nose of the aircraft.**

For two of the five exterior panels from the impact zone of WTC 1, the general shape and appearance of the recovered pieces matched photographs taken just before the building collapse. Thus, NIST was able to attribute the observed damage to the aircraft impact. NIST also made determinations regarding the connections between structural steel elements:

- There was no evidence to indicate that the joining method, weld materials, or welding procedures were inadequate. Fractures of the columns in areas away from a welded joint were the result of stretching and thinning. Perimeter columns hit by the plane tended to fracture along heat-affected zones adjacent to welds.
- The failure mode of spandrel connections varied. At or above the impact zone, bolt hole tear-out was more common. Below the impact zone, it was more common for the spandrels to be ripped from the panels. There was no evidence that fire exposure changed these failure modes.
- The exterior column splices at the mechanical floors, which were welded in addition to being bolted, generally did not fail. The column splices at the other floors generally failed by bolt fracture.
- The perimeter truss connectors (or seats) below the impact zone in WTC 1 were predominantly bent down or torn off completely. Above the impact zone, the seats were as likely to be bent upward as downward. Core seats could not be categorized since their as-built locations could not be determined.
- Failure of core columns was a result of both splice connection failures and fracture of the columns themselves.

Examination of photographs showed that 16 of the exterior panels recovered from WTC 1 were exposed to fire prior to the building collapse. None of the nine recovered panels from within the fire floors of WTC 2 were directly exposed to fire. NIST used two methods to estimate the maximum temperatures that the steel members had reached:

- Observations of paint cracking due to thermal expansion. Of the more than 170 areas examined on 16 perimeter column panels, only three columns had evidence that the steel reached temperatures above 250 °C: east face, floor 98, inner web; east face, floor 92, inner web; and north face, floor 98, floor truss connector. Only two core column specimens had sufficient paint remaining to make such an analysis, and their temperatures did not reach 250 °C. NIST did not generalize these results, since the examined columns represented only 3 percent of the perimeter columns and 1 percent of the core columns from the fire floors.
- Observations of the microstructure of the steel. High temperature excursions, such as due to a fire, can alter the basic structure of the steel and its mechanical properties. Using metallographic analysis, NIST determined that there was no evidence that any of the samples had reached temperatures above 600 °C.

These results were for a very small fraction of the steel in the impact and fire zones. Nonetheless, these analyses indicated some zones within WTC 1 where the computer simulations should not, and did not, predict highly elevated steel temperatures.

## 6.5 INFORMATION GAINED FROM OTHER WTC FIRES

There had been numerous fires in the towers prior to September 11, 2001. From these, NIST learned what size fire WTC 1 and WTC 2 had withstood and how the tower occupants and the responders functioned in emergencies. While The Port Authority's records of prior fires were lost in the collapses, FDNY provided reports on 342 fires that had occurred between 1970 and 2001.

Most of these fires were small, and occupants extinguished many of them before FDNY arrival. Forty-seven of these fires activated one to three sprinklers and/or required a standpipe hose for suppression. Only two of the fires required the evacuation of hundreds of people. There were no injuries or loss of life in any of these fires, and the interruptions to operations within the towers were local.

A major fire occurred in WTC 1 on February 13, 1975, before the installation of the sprinkler system. A furniture fire started in an executive office in the north end of an 11<sup>th</sup> floor office suite in the southeast corner of the building. The fire spread south and west along corridors and entered a file room. The fire flashed over, broke seven windows, and spread to adjacent offices north and south. The air conditioning system turned on, pulling air into the return air ducts. Telephone cables in the vertical shafts were ignited, destroying the fire-retarded wood paneling on the closet doors. The fire emerged on the 12<sup>th</sup> and 13<sup>th</sup> floors, but there was little nearby that was combustible. The fire also extended vertically from the 9<sup>th</sup> to the 19<sup>th</sup> floors within the telephone closet. Eventually the fire was confined to 9,000 ft<sup>2</sup> of one floor, about one-fourth of the total floor area. The trusses and columns in this area had been sprayed with BLAZE-SHIELD D insulation to a specified ½ in. thickness. Four trusses were slightly distorted, but the structure was not threatened.

Only one major fire incident resulted in a whole-building evacuation. At 12:18 p.m. on February 26, 1993, terrorists exploded a bomb in the second basement underground parking garage in the WTC complex. The blast immediately killed six people and caused an estimated \$300 million in damage. An intense fire followed and, although the flames were confined to the subterranean levels, the smoke spread into four of the seven buildings in the WTC complex. Most of the estimated 150,000 occupants evacuated the buildings, including approximately 40,000 from the affected towers. In all, 1,042 people were injured in the incident, including 15 who received blast-related injuries. The evacuation of the towers took over 4 hours. The incident response involved more than 700 firefighters (approximately 45 percent of FDNY's on-duty personnel at the time).

In addition, there was a fire on the 104<sup>th</sup> floor of WTC 1 on September 11, 2001, that apparently did not contribute to the eventual collapse, yet was quite severe. At 10:01 a.m., flames were first observed on the west face, and by 10:07 a.m., intense flames were emanating from several windows in the southern third of that face. The fire raged until the building collapsed at 10:28 a.m. Thus, the tower structure was able to withstand a sizable fire for about 20 min, presumably with the ceiling tile system heavily damaged and the truss system exposed to the flames. The 104<sup>th</sup> floor was well above the aircraft impact zone, so there should have been little damage to the sprayed fire-resistive material, which was the same (Table 5–3) as

on the floors where the fires led to the onset of the collapse. The photographic evidence showed no signs of column bowing or a floor collapse.

## **6.6 THE BUILDING STRUCTURAL MODELS**

### **6.6.1 Computer Simulation Software**

Structural modeling of each tower was required in order to:

- Establish the capability of the building, as designed, to support the gravity loads and to resist wind forces;
- Simulate the effects of the aircraft impacts; and
- Reconstruct the mechanics of the aircraft impact damage, fire-induced heating, and the progression of local failures that led to the building collapse.

The varied demands made different models necessary, and different software packages were used for each of these three functions. The reason for the choice in each case is presented in the next three sections of the report.

### **6.6.2 The Reference Models**

Under contract to NIST, Leslie E. Robertson Associates (LERA) constructed a global reference model of each tower using the SAP2000, version 8, software. SAP2000 is a software package for performing finite element calculations for the analysis and design of building structures. These global, three-dimensional models encompassed the 110 stories above grade and the six subterranean levels. The models included primary structural components in the towers, resulting in tens of thousands of computational elements. The data for these elements came from the original structural drawing books for the towers. These had been updated through the completion of the buildings and also included most of the subsequent, significant alterations by both tenants and The Port Authority. LERA also developed reference models of a truss-framed floor, typical of those in the tenant spaces of the impact and fire regions of the buildings, and of a beam-framed floor, typical of the mechanical floors.

LERA's work was reviewed by independent experts in light of the firm's earlier involvement in the WTC design. It was that earlier work, in fact, that made LERA the only source that had the detailed knowledge of the design, construction, and intended behavior of the towers over their entire 38-year life span. The accuracy of the four models was checked in two ways:

- The two global models were checked by Skidmore, Owings & Merrill (SOM), also under contract to NIST, and by NIST staff. This entailed ensuring consistency of the models with the design documents, and testing the models, for example, to ensure that the response of the models to gravity and wind loads was as intended and that the calculated stresses and deformations under these loads were reasonable.
- The global model of WTC 1 was used to calculate the natural vibration periods of the tower. These values were then compared to measurements from the tower on eight dates of winds

ranging from 11.5 mph to 41 mph blowing from at least four different directions. As shown in Table 6–3, the N-S and E-W values agreed within 5 percent and the torsion values agreed within 6 percent, both within the combined uncertainty in the measurements and calculations.

- SOM and NIST staff also checked the two floor models for accuracy. These reviews involved comparison with simple hand calculations of estimated deflections and member stresses for a simply supported composite truss and beam under gravity loading. For the composite truss sections, the steel stress results were within 4 percent of those calculated by SAP2000 for the long-span truss and within 3 percent for the short-span truss. Deflections for the beams and trusses matched hand calculations to within 5 percent to 15 percent. These differences were within the combined uncertainty of the methods.

**Table 6–3. Measured and calculated natural vibration periods (s) for WTC 1.**

	Direction of Motion		
	N-S	E-W	Torsion
Average of Measured Data	11.4	10.6	4.9
Original Predicted Values	11.9	10.4	–
Reference Global Model Predictions	11.4	10.7	5.2

The few discrepancies between the developed models and the original design documents, as well as the areas identified by NIST and SOM as needing modification, were corrected by LERA and approved by NIST. The models then served as references for more detailed models for aircraft impact damage analysis and for thermal-structural response and collapse initiation analysis.

NIST also used these global reference models to establish the baseline performance of the towers under gravity and wind loads. The two key performance measures calculated were the demand-to-capacity ratio (DCR) and the drift.

- Demand is defined as the combined effects of the dead, live, and wind loads imposed on a structural component, e.g., a column. Capacity is the permissible strength for that component. Normal design aims at ensuring that DCR values for all components be 1.0 or lower. A value of DCR greater than 1.0 does not imply failure since designs inherently include a margin of safety.
- Drift is the extent of sway of the building under a lateral wind. Excessive deflection can cause cracking of partitions and cladding, and, in severe cases, building instability that could affect safety.

Using SAP2000, NIST found that, under original WTC design loads, a small fraction of the structural components had DCR values greater than 1.0. (Most DCR values of that small fraction were less than 1.4, with a few as high as 1.6.) For the perimeter columns, DCR values greater than 1.0 were mainly near the corners, on floors near the hat truss, and below the 9<sup>th</sup> floor. For the core columns, these members were on the 600 line between floors 80 and 106 and at core perimeter columns 901 and 908 for much of their height. (See Figure 1–5 for the column numbers.) One possible explanation to the cause of DCRs in excess of 1.0 may lie in the computer-based structural analysis and software techniques employed for this

baseline performance study in comparison with the relatively rudimentary computational tools used in the original design nearly 40 years ago.

As part of its wind analysis, NIST calculated the drift at the top of the towers to be about 5 ft in a nearly 100 mph wind—the wind load used in the original design. Common practice was, and is, to design for substantially smaller deflections; but drift was not, and still is not, a design factor prescribed in building codes.

The estimation of wind-induced loads on the towers emerged as a problem. Two sets of wind tunnel tests and analyses were conducted in 2002 by independent laboratories as part of insurance litigation unrelated to the NIST Investigation. The estimated loads differed by as much as 40 percent. NIST analysis found that the two studies used different approaches in their estimations. This difference highlighted limitations in the current state of practice in wind engineering for tall buildings and the need for standards in the field of wind tunnel testing and wind effects estimation.

### **6.6.3 Building Structural Models for Aircraft Impact Analysis**

Ideally, the Investigation would have used the reference global models of the towers as the “targets” for the aircraft. However, this was not possible. The impact simulations required inclusion of both a far higher level of detail of the building components and also the highly nonlinear behavior of the tower and aircraft materials, and the larger model size could not be accommodated by the SAP2000 program. There were also physical phenomena for which algorithms were not available in this software. Another finite element package, LS-DYNA, satisfied these requirements and was used for the impact simulations.

Early in the effort, it became clear to both NIST and to ARA, Inc., the NIST contractor that performed the aircraft impact simulations, that the model had to “fit” on a state-of-the-art computer cluster and to run within weeks rather than months. To minimize the model size while keeping sufficient fidelity in the impact zone to capture the building deformations and damage distributions, various tower components were depicted with different meshes (different levels of refinement). For example, tower components in the path of the impact and debris field were represented with a fine mesh (higher resolution) to capture the local impact damage and failure, while components outside the impact zone were depicted more coarsely, simply to capture their structural stiffness and inertial properties. The model of WTC 1 included floors 92 through 100; the model of WTC 2 extended from floor 77 through floor 85. The combined tower and aircraft model of more than two million elements, at time steps of just under a microsecond, took approximately two weeks of computer time on a 12-noded computer cluster to capture the needed details of the fraction of a second it took for the aircraft and its fragments to come to rest inside the building.

The structural models, partially shown in Figures 6–6 through 6–9, included:

- Core columns and spliced column connections;
- Floor slabs and beams within the core;
- Exterior columns and spandrels, including the bolted connections between the exterior panels in the refined mesh areas; and
- Tenant space floors, composed of the combined floor slab, metal decking, and steel trusses.



They also included representations of the interior partitions and workstations. The live load mass was distributed between the partitions and cubicle workstations.

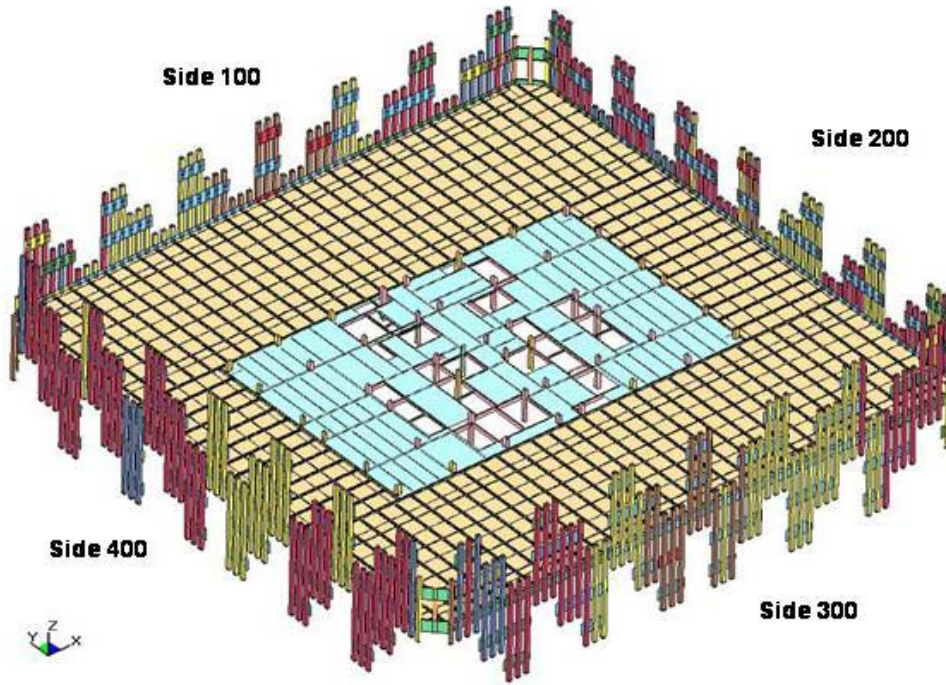

Figure 6-6. Structural model of the 96<sup>th</sup> floor of WTC 1.

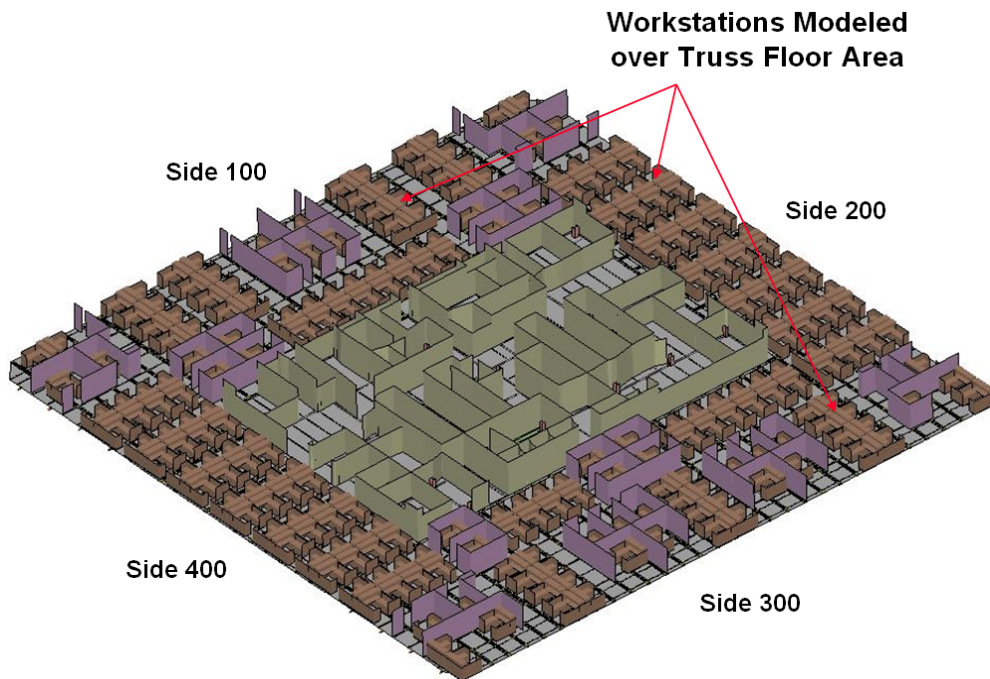

Figure 6-7. Model of the 96<sup>th</sup> floor of WTC 1, including interior contents and partitions.

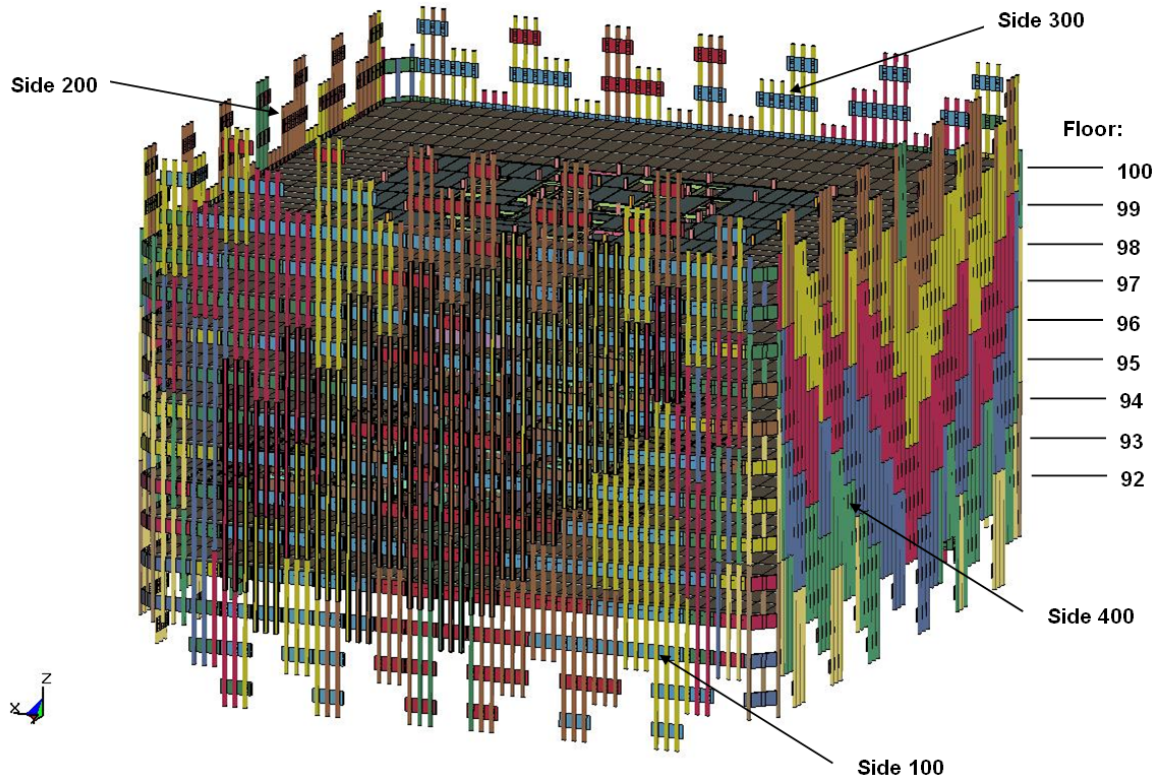

Figure 6–8. Multi-floor global model of WTC 1, viewed from the north.

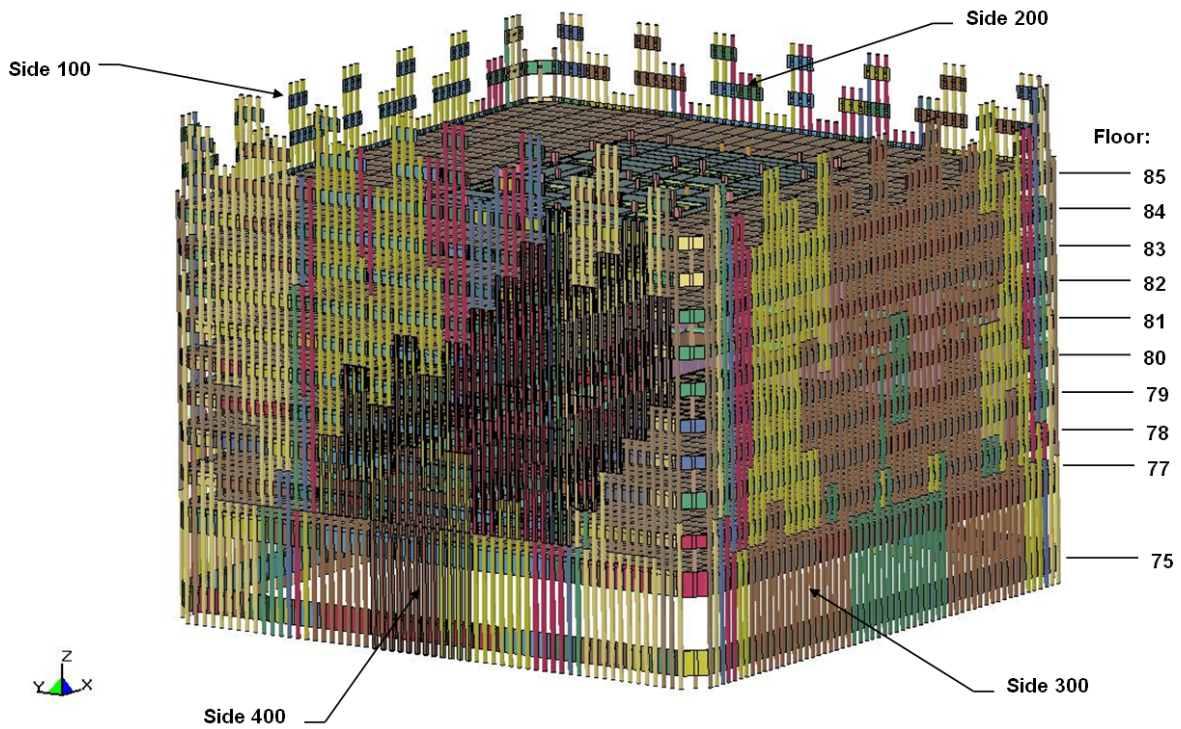

Figure 6–9. Multi-floor global model of WTC 2, viewed from the south.

Within these models, it was critical that the structural and furnishing materials behaved correctly when impacted by the aircraft or debris. For each grade of steel, the stress-strain behavior and the yield strength were represented using data from tests conducted at NIST. The weakening and failure of the concrete floor slabs were simulated using material models embedded in LS-DYNA. The primary influence of the nonstructural components on the impact behavior was their inertial contribution. Values for the resistance to rupture of gypsum panels and the fracture of the wood products in the workstations were obtained from published studies.

In order to complete the global models of the two towers, models of sections of the buildings were developed. As shown in Section 6.8.1, these submodels enabled efficient identification of the principal features of the interaction of the buildings with specific aircraft components.

#### **6.6.4 Building Structural Models for Structural Response to Impact Damage and Fire and Collapse Initiation Analysis**

The structural response and collapse analysis of the towers was conducted in three phases by NIST and Simpson Gumpertz & Heger, Inc. (SGH), under contract to NIST. The first phase included component and detailed subsystem models of the floor and exterior wall panels. The objectives of Phase 1 were to gain understanding into the response of the structure under stress and elevated temperatures, identify dominant modes of failure, and develop reductions in modeling complexity that could be applied in Phase 2. The second phase analyzed major subsystem models (the core framing, a single exterior wall, and full tenant floors) to provide insight into their behavior within the WTC global system. The third phase was the analysis of global models of WTC 1 and WTC 2 that took advantage of the knowledge gained from the more detailed and subsystem models. A separate global analysis of each tower helped determine the relative roles of impact damage and fires with respect to structural stability and sequential failures of components and subsystems and was used to determine the probable collapse initiation sequence.

### **Phase 1: Component and Detailed Subsystem Analyses**

#### ***Floor Subsystem Analysis***

The floors played an important role in the structural response of the WTC towers to the aircraft impact and ensuing fires. Prior to the development of a floor subsystem model, three component analyses were conducted, as follows:

- **Truss seats.** Figure 6–10 shows how an exterior seat connection was represented in the finite element structural model. The component analysis determined that failure could occur at the bolted connection between the bearing angle and the seat angle, and the truss could slip off the seat. Truss seat connection failure from vertical loads was found to be unlikely, since the needed increase in vertical load was unreasonable for temperatures near 600 °C to 700 °C.
- **Knuckles.** The “knuckle” was formed by the extension of the truss diagonals into the concrete slab and provided for composite action of the steel truss and concrete slab. A model was developed to predict the knuckle performance when the truss and concrete slab acted compositely.

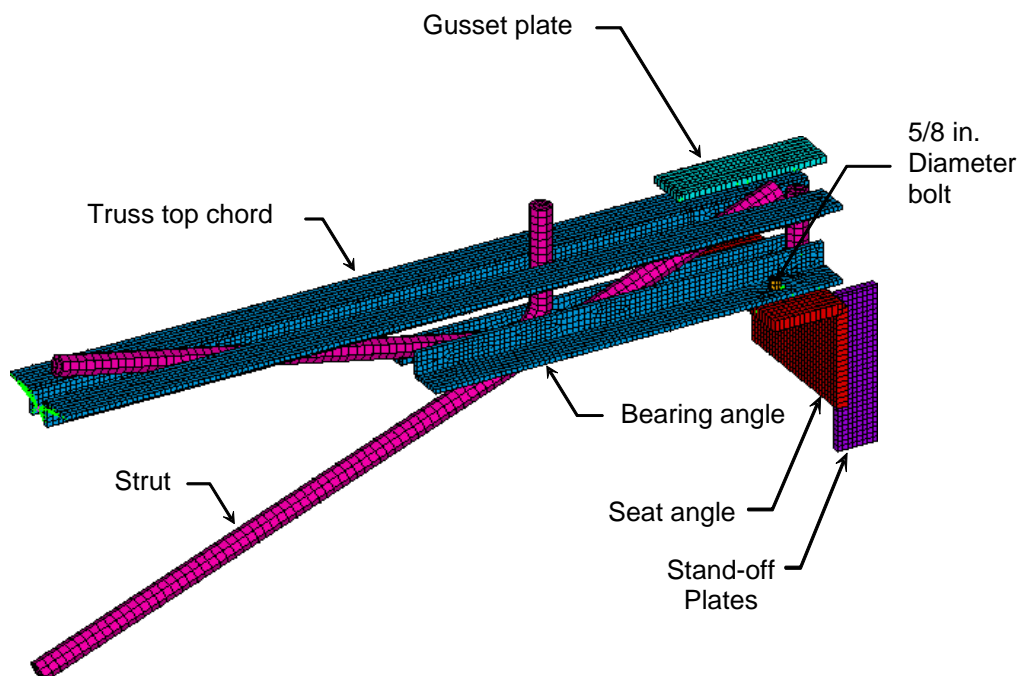

**Figure 6–10. Finite element model of an exterior truss seat.**

- Single composite truss and concrete slab section. A floor section was modeled to investigate failure modes and sequences of failures under combined gravity and thermal loads. The floor section was heated to 700 °C (with a linear thermal gradient through the slab thickness from 700 °C to 300 °C at the top surface of the slab) over a period of 30 min. Initially the thermal expansion of the floor pushed the columns outward, but with increased temperatures, the floor sagged and the columns were pulled inward. Knuckle failure was found to occur mainly at the ends of the trusses and had little effect on the deflection of the floor system. Figure 6–11 shows that the diagonals at the core (right) end of the truss buckled and caused an increase in the floor system deflection, ultimately reaching approximately 42 in. Two possible failure modes were identified for the floor-truss section: sagging of the floor and loss of truss seat support.

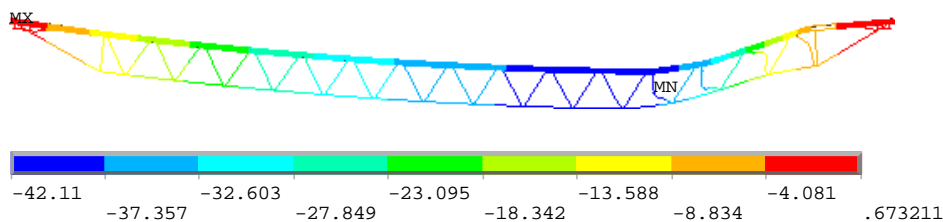

**Figure 6–11. Vertical displacement at 700 °C.**

A finite element model of the full 96<sup>th</sup> floor of WTC 1 was translated from the SAP2000 reference models into ANSYS 8.1 for detailed structural evaluation (Figure 6–12)<sup>14</sup>. The two models generated comparable predictions of the behavior under dead or gravity loads.

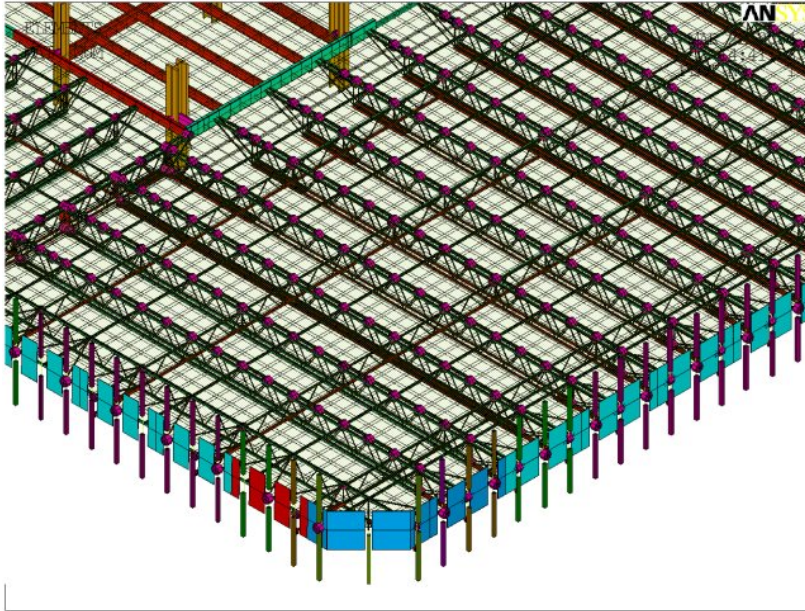

**Figure 6–12. ANSYS model of 96<sup>th</sup> floor of WTC 1.**

The model was used to evaluate structural response under dead and live loads and elevated temperatures, identify failure modes and associated temperatures and times to failure, and identify reductions in modeling complexity for global models and analyses. The structural response included thermal expansion of steel and concrete members, temperature-dependent properties of steel and concrete that affected material stiffness and strength, and bowing or buckling of structural members. The deformation and failure modes identified were floor sagging between truss supports, floor sagging resulting from failure of a seat at either end of the truss, and failure of the floor subsystem truss supports.

### ***Exterior Wall Subsystem***

The exterior walls played an important role in each tower's reaction to the aircraft impact and the ensuing fires. Photographic and video evidence showed inward bowing of large sections of the exterior walls of both towers just prior to the time of collapse.

A finite element model of a wall section was developed in ANSYS for evaluation of structural response under dead and live loads and elevated structural temperatures, determination of loads that would have caused buckling, and identification of reductions of modeling complexity for global models and analyses. The modeled unit consisted of seven full column/spandrel panels (described in Section 1.2.2) and portions of four other panels. The model was validated against the reference model developed by LERA (Section 6.6.2) by comparing the stiffness for a variety of loading conditions.

<sup>14</sup> ANSYS allowed including the temperature-varying properties of the structural materials, a necessary feature not available in SAP 2000.

The model was subjected to several gravity loads and heating conditions, several combinations of disconnected floors, and pull-in from sagging floors until the point of instability. In one case, the simulation assumed three disconnected floors, and the top of the wall subsystem was subjected to “push-down” analysis, i.e., an increasing force to provide a measure of remaining capacity in the wall section.

The model captured possible failure modes due large lateral deformations, column buckling from loss of support at floor truss seats and diagonal straps, failure of column splice bolts, and failure of spandrel splice bolts or tearing of spandrel or splice plates at bolt holes. The model also showed:

- Large deformations and buckling of the spandrels could be expected at high temperatures, but they did not significantly affect the stability of the exterior columns and generally did not need to be precisely modeled in the tower models.
- Partial separations of the spandrel splices could be expected at elevated temperatures, but they also did not significantly affect the stability of the exterior columns.
- Exterior column splices could be expected to fail at elevated temperatures and needed to be accurately modeled.
- Plastic buckling of columns, with an ensuing rapid reduction of load, was to be expected at extremely high loads and at low temperatures.
- The sagging of trusses resulted in approximately 14 kip of inward pull per truss seat on the attached perimeter column.

## **Phase 2: Major Subsystem Analyses**

Building on these results, ANSYS models were constructed of each of the three major structural subsystems (core framing, a single exterior wall, and full composite floors) for each of the towers. The models were subjected to the impact damage and elevated temperatures from the fire dynamics and thermal analyses to be described later in this chapter.

### ***Core Framing***

The two tower models included the core columns, the floor beams, and the concrete slabs from the impact and fire zones to the highest floor below the hat truss structure: from the 89<sup>th</sup> floor to the 106<sup>th</sup> floor for WTC 1 and from the 73<sup>rd</sup> floor to the 106<sup>th</sup> floor for WTC 2. Within these floors, aircraft-damaged structural components were removed. Below the lowest floors, springs were used to represent the stiffness of the columns. In the models, the properties of the steel varied with temperature, as described in Section 5.5.2. This allowed for realistic structural changes to occur, such as thermal expansion, buckling, and creep.

The forces applied to the models included gravity loads applied at each floor, post-impact column forces applied at the top of the model at the 106<sup>th</sup> floor, and temperature histories applied at 10 min intervals with linear ramping between time intervals.

Under these conditions, the investigators first determined the stability of the core under impact conditions and then its response under thermal loads:

- In WTC 1, the core was stable under Case A (base case) impact damage, but the model could not reach a stable solution under Case B (more severe) impact damage.
- The WTC 1 core became unstable under Case A impact damage and Case B thermal loads as it leaned to the northwest (due to insulation dislodged from the northwest corner column); the core model was restrained in horizontal directions at floors above the impact zone half way through the thermal loads.
- The WTC 2 core was stabilized for Case C (base case) by providing horizontal restraint at all floors representing the restraint provided by the perimeter wall to resist leaning to the southeast. A converged, stable solution was not found for Case D (more severe) impact damage.
- The WTC 2 stabilized core model for Case C impact damage was subjected to Case D thermal loads.

Following each simulation, a pushdown analysis was performed to determine the core's reserve capacity. The analysis results showed that:

- The WTC 1 isolated core structure was most weakened from thermal effects at the center of the south side of the core. (Smaller displacements occurred in the global model due to the constraints of the hat truss and floors.)
- The WTC 2 isolated core was most weakened from thermal effects at the southeast corner and along the east side of the core. (Larger displacements occurred in the global model as the isolated core model had lateral restraints imposed that were somewhat stiffer than in the global model.)

### ***Composite Floor***

The composite floor model was used to determine the response of a full floor to Case A and B thermal loads for WTC 1 floors and Case C and D thermal loads for WTC 2 floors. It included:

- A reduced complexity truss model, validated against the single truss model results.
- Primary and bridging trusses, deck support angles, spandrels, core floor beams, and a concrete floor slab.
- Fire-generated local temperature histories applied at 10 min intervals with linear ramping between time intervals.
- Temperature-dependent concrete and steel properties, except for creep behavior.

- Restraint provided by exterior and core columns, which extended one floor above and below the modeled floor. The potential for large deflections and buckling of individual structural members and the floor system were included.

The results showed that:

- At lower elevated temperatures (approximately 100 °C to 400 °C), the floors thermally expanded and displaced the exterior columns outward by a few inches; horizontal displacement of the core columns was insignificant. None of the floors buckled as they thermally expanded, even with the exterior columns restrained so that no horizontal movement was allowed at the floors above and below the heated floor, which maximized column resistance to floor expansion. Even with this level of column restraint, the exterior columns did not develop a sufficient reaction force (push inward to resist the expansion outward) to buckle any of the floors.
- At higher elevated temperatures (above 400 °C), the floors began to sag as the floors' stiffness and strength were reduced with increasing temperature, and the difference in thermal expansion between the trusses and the concrete slab became larger. As the floor sagging increased, the outward displacement of the exterior columns was overcome, and the floors exerted an inward pull force on the exterior columns.
- Floor sagging was caused primarily by either buckling of truss web diagonals or disconnection of truss seats at the exterior wall or the core perimeter. Except for the truss seat failures near the southeast corner of the core in WTC 2 following the aircraft impact, web buckling or truss seat failure was caused primarily by elevated temperatures of the structural components.
- Analysis results from the detailed truss model found that the floors began to exert inward pull forces when floor sagging exceeded approximately 25 in. for the 60 ft floor span.
- Sagging at the floor edge was due to loss of vertical support at the truss seats. The loss of vertical support was caused in most cases by the reduction in vertical shear capacity of the truss seats due to elevated steel temperatures.
- Case B impact damage and thermal loads for WTC 1 floors resulted in floor sagging on the south side of the tower over floors that reasonably matched the location of inward bowing observed on the south face. Case A impact damage and thermal loads did not result in sagging on the south side of the floors.
- Cases C and D impact damage and thermal loads for WTC 2 both resulted in floor sagging on the east side of the tower over floors that reasonably matched the location of inward bowing observed on the east face. However, Case D provided a better match.



### ***Exterior Wall***

Exterior wall models were developed for the south face of WTC 1 (floors 89 to 106) and the east face of WTC 2 (floors 73 to 90). These sections were selected based on photographic evidence of column bowing.

Many of the simulation conditions were similar to those for the isolated core modeling: removal of aircraft-damaged structural components, representation of lower floors by springs, temperature-varying steel properties, gravity loads applied at each floor, post-impact column forces applied at the 106<sup>th</sup> floor, and temperature histories applied at 10 min intervals with linear ramping between time intervals.

The analysis results showed that:

- Inward pull forces were required to produce inward bowing consistent with the displacements measured from photographs. The inward pull was caused by sagging of the floors. Heating of the inside faces of the exterior columns also contributed to inward bowing.
- Exterior wall sections bowed outward in a pushdown analysis when several consecutive floors were disconnected, the interior face of the columns was heated, and column gravity loads increased (e.g., due to load redistribution from the core and hat truss). At lower temperatures, thermal expansion of the inside face was insufficient to result in inward bowing of the entire exterior column. At higher temperatures, outward bowing resulted from the combined effects of reduced steel strength on the heated inside face, which shortened first under column gravity loads, and the lack of lateral restraint from the floors.
- The observed inward bowing of the exterior wall indicated that most of the floor connections must have been intact to cause the observed bowing.
- The extent of floor sagging observed at each floor was greater than that predicted by the full floor models. The estimates of the extent of sagging at each floor was governed by the combined effects of insulation damage and fire; insulation damage estimates were limited to areas subject to direct debris impact. Other sources of floor and insulation damage from the aircraft impact and fires (e.g., insulation damage due to shock and subsequent vibrations as a result of aircraft impact or concrete slab cracking and spalling as a result of thermal effects) were not included in the floor models.
- Case B impact damage and thermal loads for the WTC 1 south wall, combined with pull-in forces from floor sagging, resulted in an inward bowing of the south face that reasonably matched the observed bowing. The lack of floor sagging for the Case A impact damage and thermal loads resulted in no inward bowing for the south face.
- Cases D impact damage and thermal loads for the WTC 2 east wall, combined with pull-in forces from floor sagging, resulted in an inward bowing of the east face that reasonably matched the observed bowing.

### Phase 3: Global Modeling

The global models were used for the two final simulations and provided complete analysis of results and insight into the subsystem interactions leading to the probable collapse sequence. Based upon the results of the major subsystem analyses, impact damage and thermal loads for Cases B and D were used for WTC 1 and WTC 2, respectively. The models extended from floor 91 for WTC 1 and floor 77 for WTC 2 to the roof level in both towers. Although the renditions of the structural components had been reduced in complexity while maintaining essential nonlinear behaviors, based on the findings from the component and subsystem modeling, the global models included many of the features of the subsystem models:

- Removal of aircraft-damaged structural components.
- Application of gravity loads following removal of aircraft damaged components and prior to thermal loading.
- Temperature-dependent concrete and steel properties.
- Creep strains for column components.
- Representation of lower floors by springs.
- Local temperature histories applied at 10 min intervals with linear ramping between time intervals.

There were several adjustments to the models based on the findings from the subsystem modeling:

- Removal of thermal expansion from the spandrels and equivalent slabs in the tenant area to avoid local buckling that affected convergence but had little influence on global collapse initiation.
- Representing the WTC 2 structure above the 86<sup>th</sup> floor as a single “super-element” to reduce model complexity. The floors above the impact zone had only exhibited linear behavior in the previous analyses. This modification assumed linear behavior of the hat truss, which was checked as part of the review of analysis results.
- Representation of the lower part of the tower (starting several floors below the impact damage) as a super-element. This prevented the use of construction sequence in applying gravity loads to the model (where loads are applied in stages to simulate the construction of the building). The lack of construction sequence increased the forces on the exterior columns slightly, and decreased those on the core columns slightly.

The inclusions of creep for column components was necessary for the accuracy of the models, but its addition also greatly increased the computation time. As a result, the simulations of WTC 1 took 22 days and those of WTC 2 took 14 days on a high-end computer workstation. The results of these simulations are presented in Section 6.14.

## 6.7 THE AIRCRAFT STRUCTURAL MODEL

Due to their similarity, the two Boeing 767-200ER aircraft were represented by a single, finite element model, two views of which are shown in Figure 6–13. The model consisted of about 800,000 elements. The typical element dimensions were between 1 in. and 2 in. for small components, such as spar or rib flanges, and 3 in. to 4 in. for large parts such as the wing or fuselage skin. Structural data on which to base the model were collected from the open literature, electronic surface models and CAD drawings, an inspection of a 767-300ER, Pratt and Whitney Engine Reference Manuals, American Airlines and United Airlines, and the Boeing Company website.

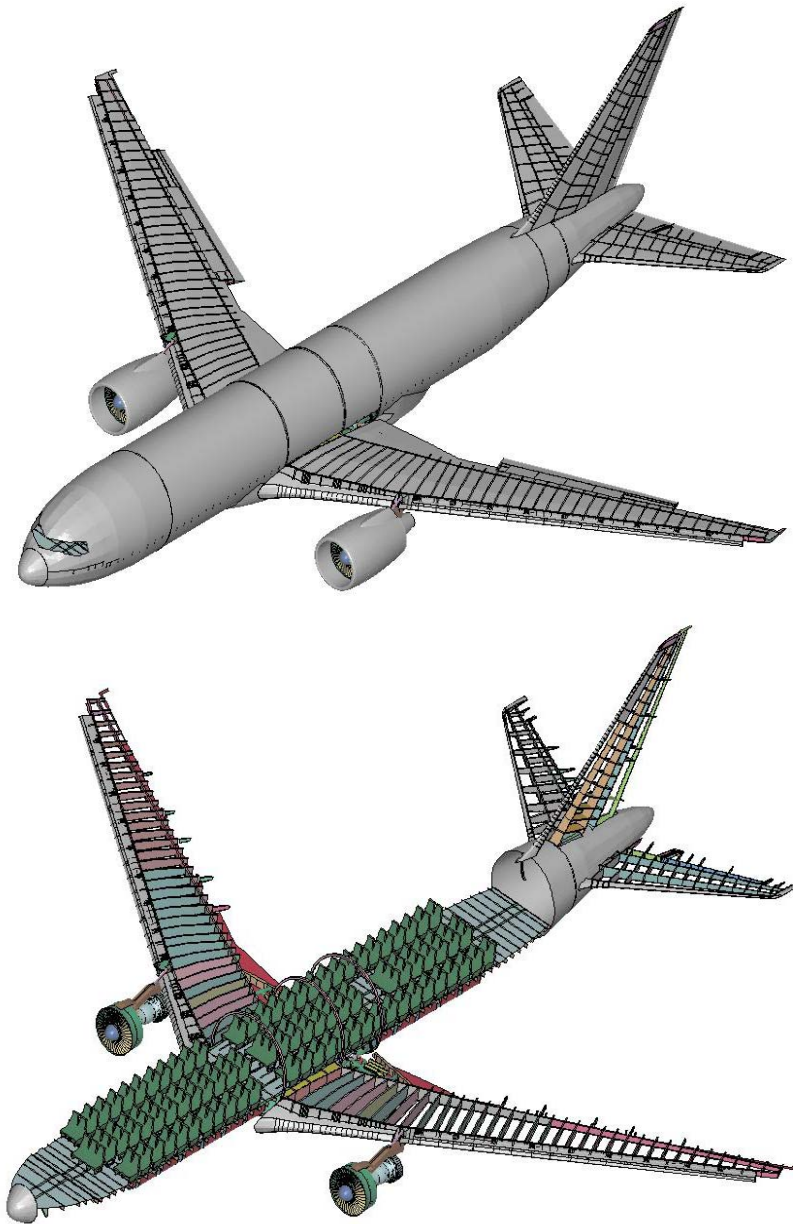
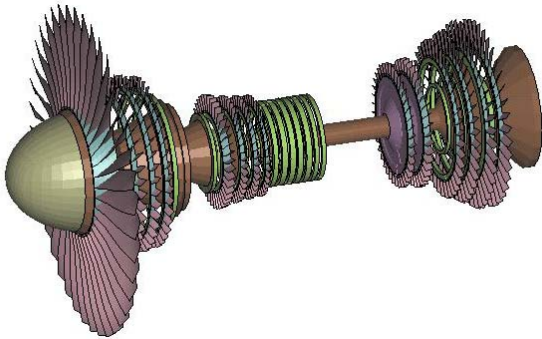
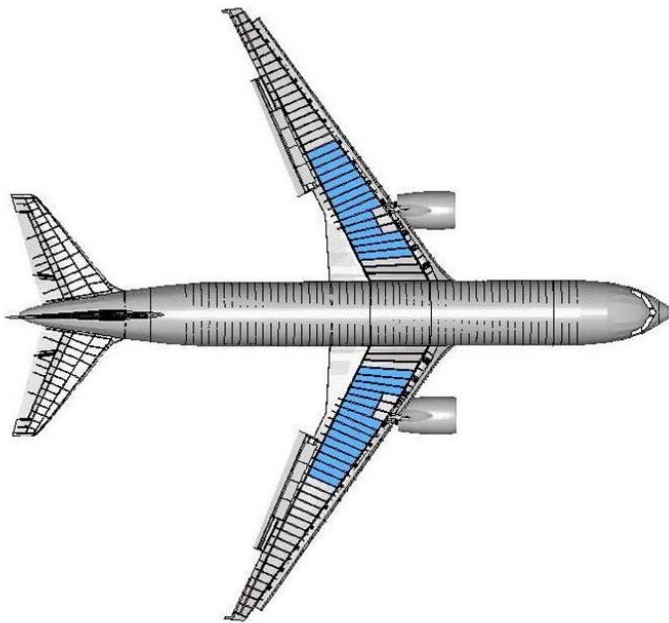

Figure 6–13. Finite element model of the Boeing 767-200ER.

More detailed models of subsections of the aircraft were constructed for the component level analyses described below. Special emphasis was placed on modeling the aircraft engines, due to their potential to produce significant damage to the tower components. The element dimensions were generally between 1 in. and 2 in., although even smaller dimensions were required to capture some details of the engine geometry. The various components of the resulting engine model are shown in Figure 6–14. Fuel was distributed in the wing as shown in Figure 6–15 based on a detailed analysis of the fuel distribution at the time of impact.



**Figure 6–14. Pratt & Whitney PW4000 turbofan engine model.**



**Figure 6–15. Boeing 767-200ER showing the jet fuel distribution at time of impact.**

## 6.8 AIRCRAFT IMPACT MODELING

### 6.8.1 Component Level Analyses

Prior to conducting the full simulations of the aircraft impacting the towers, a series of smaller scale simulations was performed to develop understanding of how the aircraft and tower components fragmented and to develop the simulation techniques required for the final computations. These simulations began with finely meshed models of key components of the tower and aircraft structures and progressed to relatively coarsely meshed representations that could be used in the global models. Examples of these component-level analyses included impact of a segment of an aircraft wing with an exterior column, impact of an aircraft engine with exterior wall panels, and impact of a fuel-filled wing segment with exterior wall panels.

Figure 6–16 shows two frames from the last of these analyses, with the wing segment entering from the left, being fragmented as it penetrates the exterior columns, and spraying jet fuel downstream.

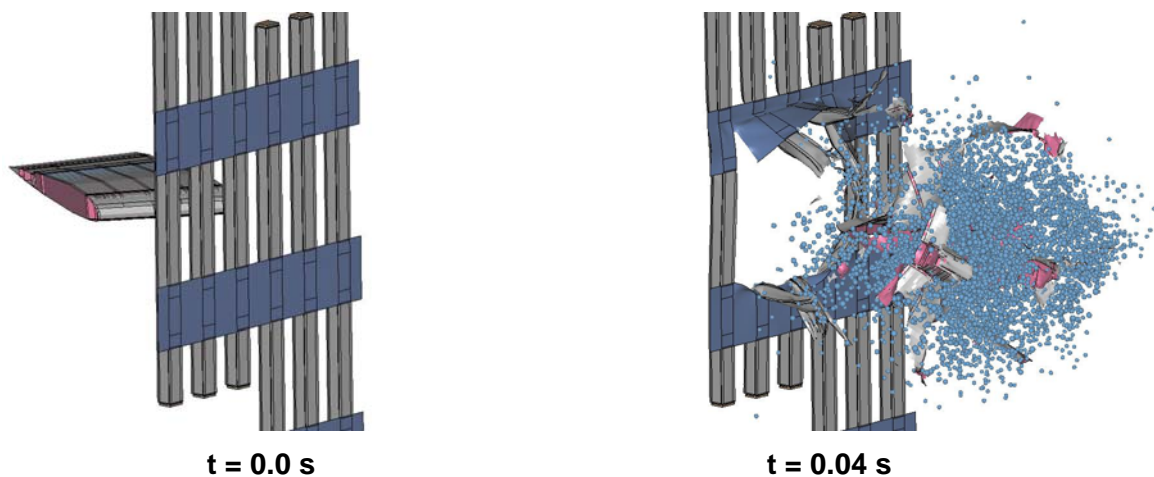

**Figure 6–16. Calculated impact on an exterior wall by a fuel-laden wing section.**

The Investigation Team gained valuable knowledge from these component impact analyses, for example:

- Moving at 500 mph, an engine broke any exterior column it hit. If the engine missed the floor slab, the majority of the engine core remained intact and had enough residual momentum to sever a core column upon direct impact.
- The impact of the inner half of an empty wing significantly damaged exterior columns but did not result in their complete failure. Impact of the same wing section, but filled with fuel, did result in failure of the exterior columns.

### 6.8.2 Subassembly Impact Analyses

Next, a series of simulations were performed for intermediate-sized sections of a tower. These subassembly analyses investigated different modeling techniques and associated model sizes, run times, numerical stability, and impact response. Six simulations were performed of an aircraft engine impacting a subassembly that included structural components from the impact zone on the north face of WTC 1, exterior panels, truss floor structures, core framing, and interior contents (workstations). One response of the structure to the engine impact is shown in Figure 6–17.

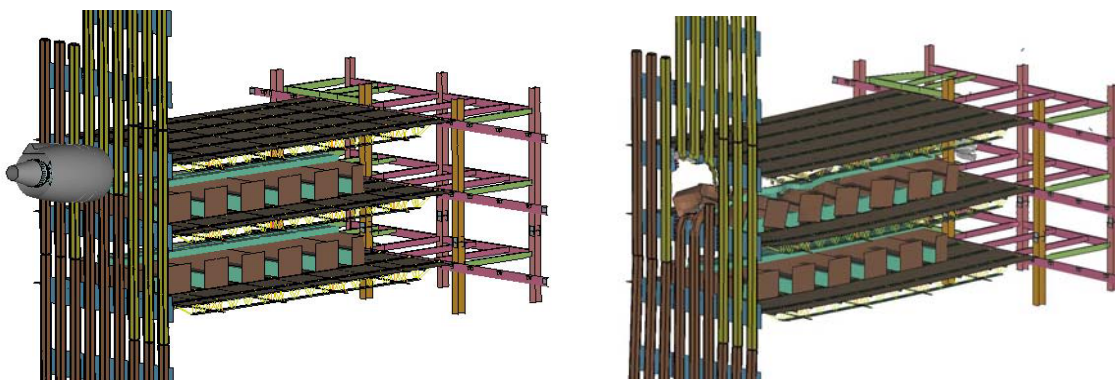

**Figure 6–17. Response of a tower subassembly model to engine impact.**

Typical knowledge gained from these simulations were:

- The mass of the concrete floor slab and nonstructural contents had a greater effect on the engine deceleration and subsequent damage than did the concrete strength.
- Variation of the failure criteria of the welds in the exterior columns did not result in any noticeable difference in the damage pattern or the energy absorbed by the exterior panels.

### 6.8.3 Aircraft Impact Conditions

From the NIST photographic and video collection, the speed and orientation of the aircraft (Table 6–4) were estimated at the time of impact. The geometry of the wings, different in flight from that at rest, was estimated from the impact pattern in the photographs and the damage documented on the exterior panels by NIST. United Airlines and American Airlines provided information on the contents of the aircraft, the mass of jet fuel, and the location of the fuel within the wing tanks.

**Table 6–4. Summary of aircraft impact conditions.**

Condition	AA 11 (WTC 1)	UAL 175 (WTC 2)
Impact Speed (mph)	443 ± 30	542 ± 24
Vertical Approach Angle	10.6° ± 3° below horizontal (heading downward)	6° ± 2° below horizontal (heading downward)
Lateral Approach Angle	180.3° ± 4° clockwise from Plan North <sup>a</sup>	13° ± 2° clockwise from Plan North <sup>a</sup>
Roll Angle (left wing downward)	25° ± 2°	38° ± 2°

a. Plan North is approximately 29 degrees clockwise from True North.

### 6.8.4 Global Impact Analysis

From the component and subassembly simulations, it became apparent that each computation of the full tower and aircraft would take weeks. Furthermore, the magnitude and location of damage to the tower structure were sensitive to a large number of initial conditions, to assumptions in the representation of the collision physics, and to any approximations in the numerical methods used to solve the physics equations. Thus, it was necessary to choose a manageable list of the factors that most influenced the outcome of a simulation. Careful screening was conducted at the component and subassembly levels, leading to identification of the following prime factors:

- Impact speed,
- Vertical approach angle of the aircraft,
- Lateral approach angle of the aircraft,
- Total aircraft weight,
- Aircraft materials failure strain,
- Tower materials failure strain, and
- Building contents weight and strength.

Guided by these results and several preliminary global simulations, two global simulations were selected for inclusion in the four-step simulation of the response of each tower, as described in Section 6.1. The conditions for these four runs are shown in Table 6–5. The computers simulate the aircraft flying into the tower, calculated the fragments that were formed from both the aircraft and the building itself, and then followed the fragments. The jet fuel, atomized upon impact into about 60,000 “blobs” averaging one pound, dispersed within and outside the building. Each simulation continued until the debris motion had reduced to a level that was not expected to produce any significant further impact damage.

**Table 6–5. Input parameters for global impact analyses.**

Analysis Parameters		WTC 1		WTC 2	
		Case A	Case B	Case C	Case D
Flight Parameters	Impact Speed	443 mph	472 mph	542 mph	570 mph
	Vertical Approach Angle	10.6°	7.6°	6.0°	5.0°
	Lateral Approach Angle	180.0°	180.0°	13.0°	13.0°
Aircraft Parameters	Weight	100 %	105 %	100 %	105 %
	Failure Strain	100 %	125 %	100 %	115 %
Tower Parameters	Failure Strain	100 %	80 %	100 %	90 %
	Live Load Weight <sup>a</sup>	25 %	20 %	25 %	20 %
	Contents Strength	100 %	100 %	100 %	80 %

a. Live load weight expressed as a percentage of the design live load.

These simulations each took about 2 weeks on a 12-node computer cluster. Figure 6–18 shows six frames from the animation of one such simulation.

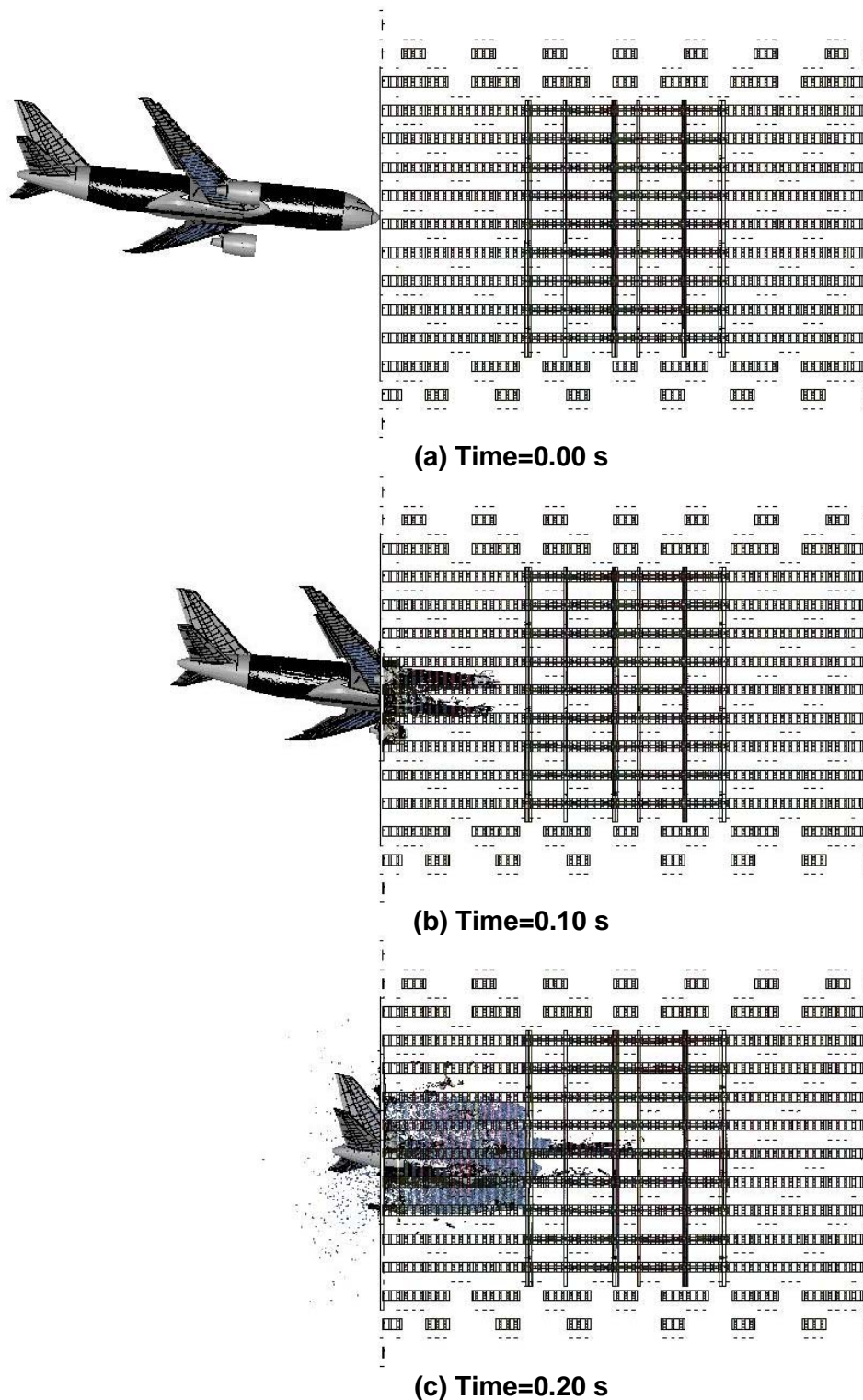
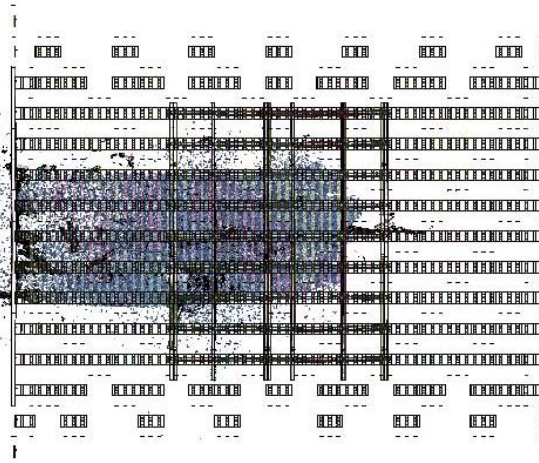
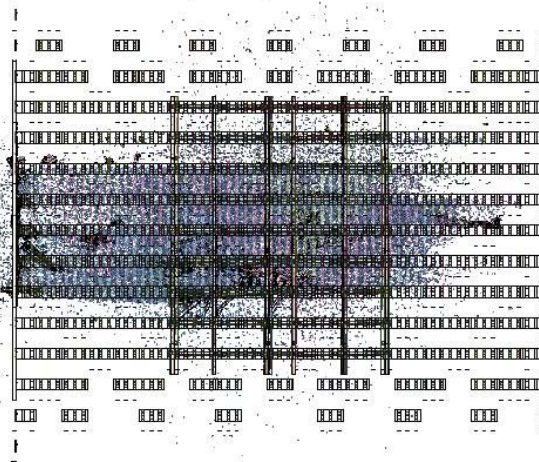

Figure 6–18. Side view of simulated aircraft impact into WTC 1, Case B.





(d) Time=0.30 s



(e) Time=0.40 s

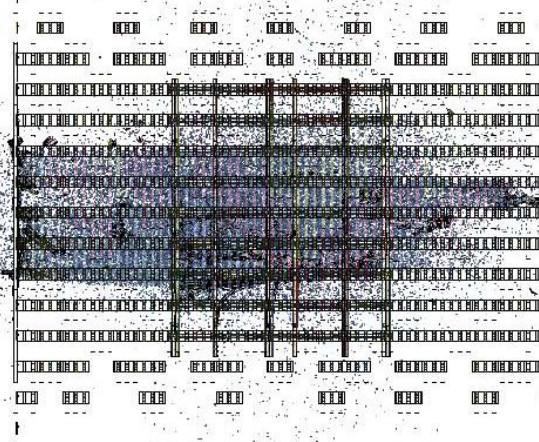

(f) Time=0.50 s

Figure 6–18. Side view of simulated aircraft impact into WTC 1, Case B (Cont.)

## 6.9 AIRCRAFT IMPACT DAMAGE ESTIMATES

### 6.9.1 Structural and Contents Damage

Each of the four global simulations generated information about the state of the structural components following the impact of the aircraft. The four degrees of column damage are defined as follows and shown graphically in Figure 6–19. The unstrained areas are blue and the highly strained areas are red.

- Lightly damaged column: column impacted, but without significant structural deformation;
- Moderately damaged column: visible local distortion, but no deformation of the column centerline;
- Heavily damaged column: Permanent deflection of the column centerline; and
- Failed column: Column severed.

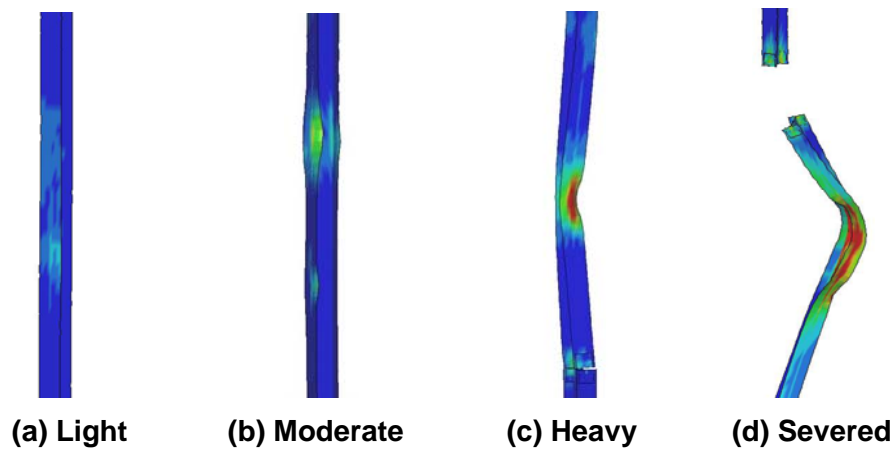

Figure 6–19. Column damage levels.

Figure 6–20 shows the calculated damage to a floor slab. Figure 6–21 shows the response of the furnishings and the jet fuel to the impact. Figures 6–22 through 6–25 show the combined damage for all floors for the four global simulations. The latter proved useful in visualizing the extent of aircraft impact in one graphic image.

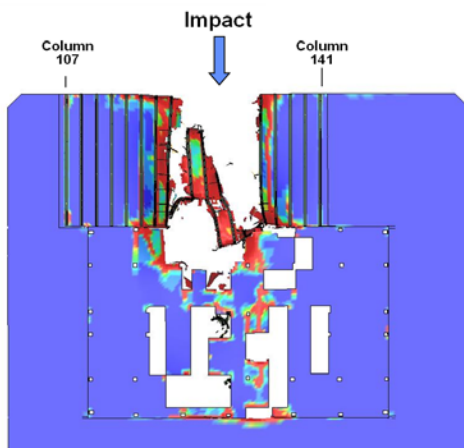
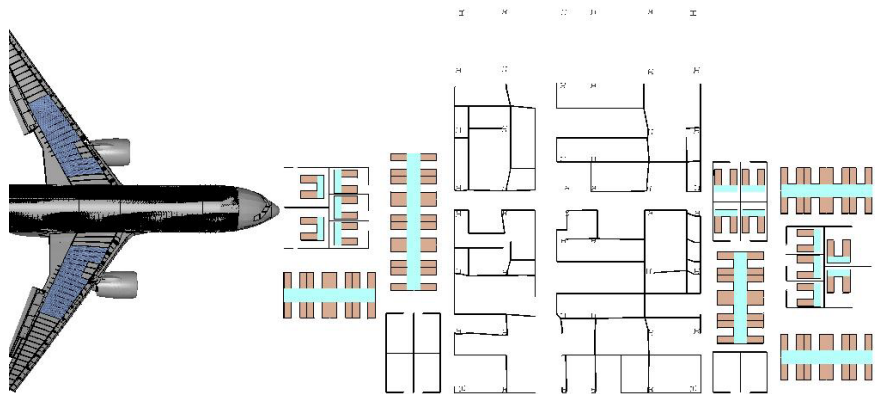

Figure 6–20. Case B damage to the slab of floor 96 of WTC 1.



(a) Pre-impact configuration



(b) Calculated impact response

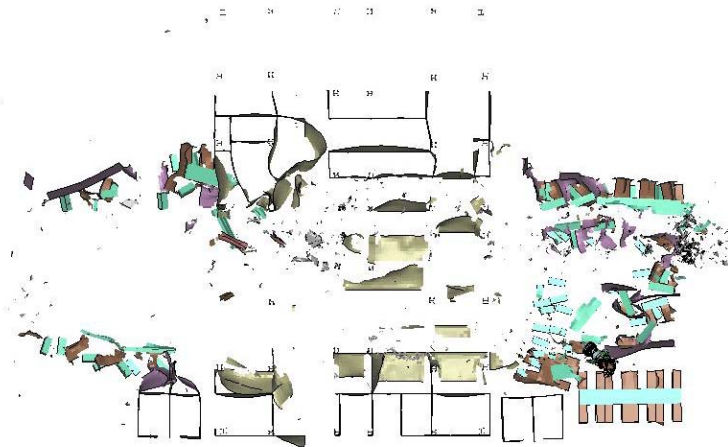

(c) Calculated impact response (fuel removed)

Figure 6–21. Case B simulation of response of contents of 96<sup>th</sup> floor of WTC 1.

**Severe Floor Damage**

Floor fireproofing ■

Floor system structural damage ■

Floor system removed

**Column Damage**

Severed ○

Heavy damage ○

Moderate damage ○

Light damage ○

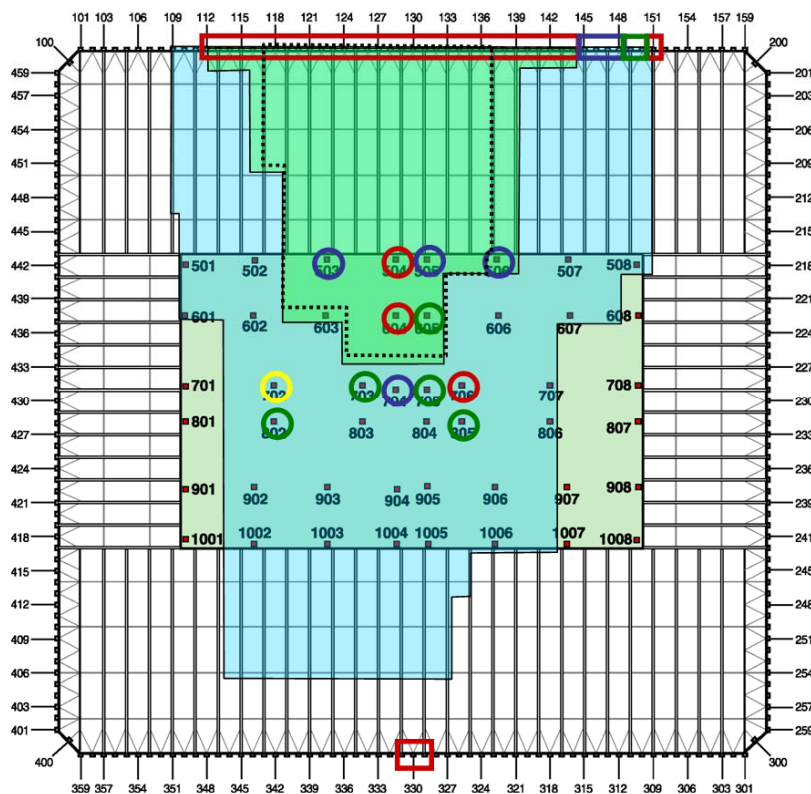
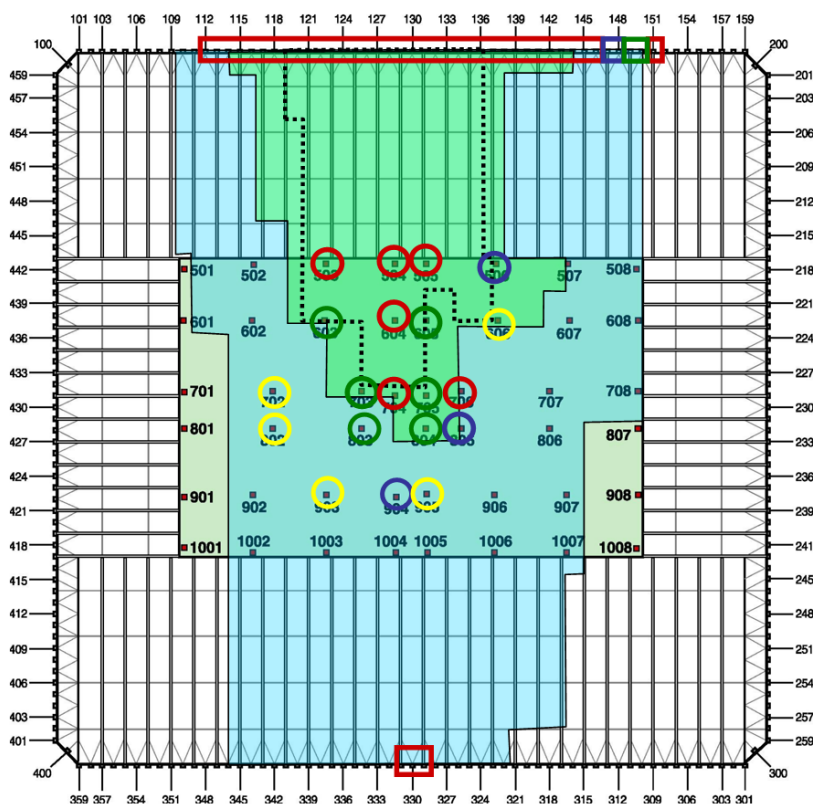

Figure 6–22. Combined structural damage to the floors and columns of WTC 1, Case A.

Figure 6–23. Combined structural damage to the floors and columns of WTC 1, Case B.



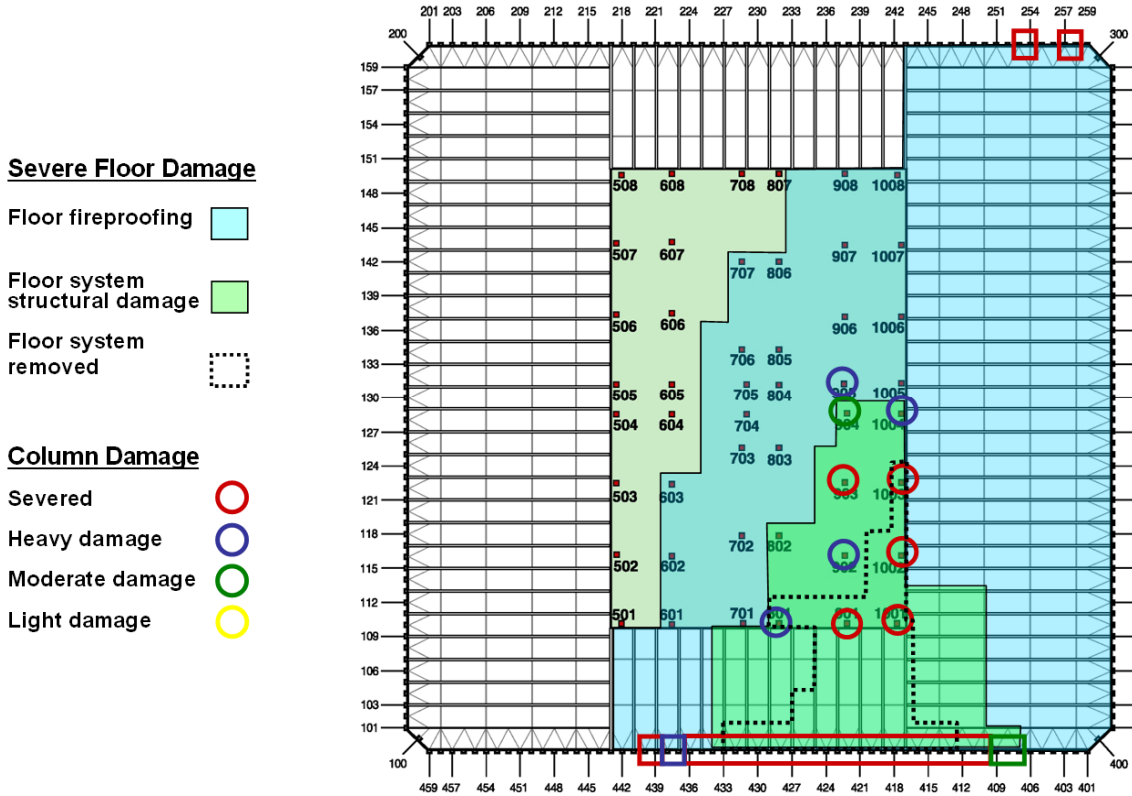
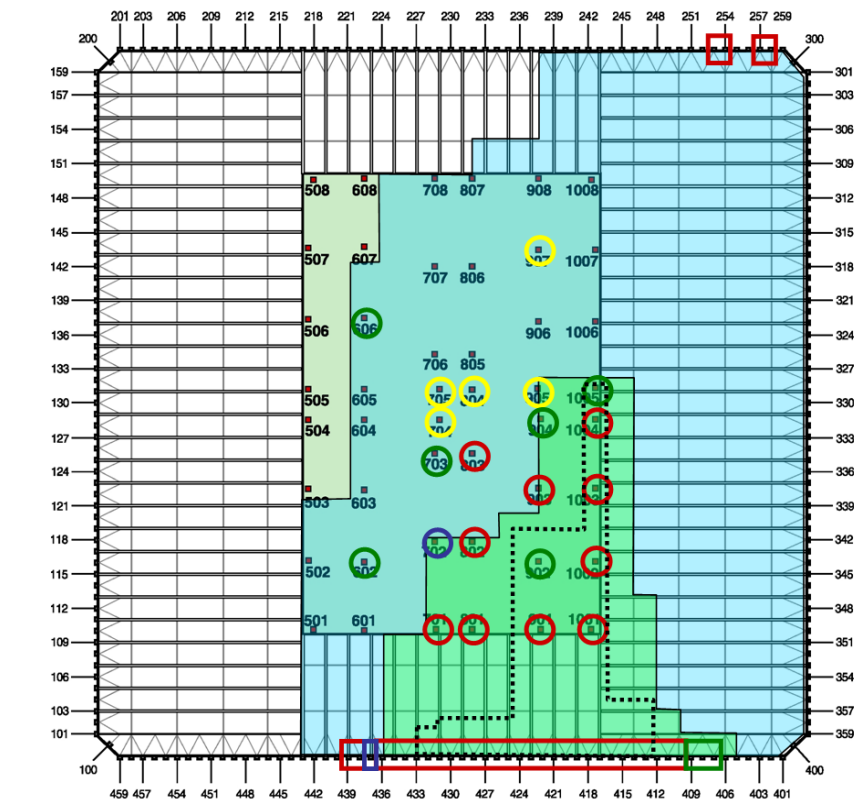

Figure 6-24. Combined structural damage to the floors and columns of WTC 2, Case C.

Figure 6-25. Combined structural damage to the floors and columns of WTC 2, Case D.



## 6.9.2 Validity of Impact Simulations

Assessment of the aircraft impact simulations of exterior damage to the towers involved comparing the predicted perimeter wall damage near the impact zone with post-impact photographs of the walls.

Figure 6–26 shows a photograph of the north face of WTC 1 after impact and the results of the Case A simulation. The calculated silhouettes capture both the position and shape of the actual damage.

Figures 6–27 and 6–28 depict more detailed comparisons between the observed and calculated damage. The aircraft hole is shown in white. The colored dots characterize the mode in which the steel or connection failed (e.g., severed bolt, ripped weld) and the magnitude of the deformation of the steel:

- Green: proper match of failure mode and magnitude
- Yellow: proper match in the failure mode, but not the magnitude
- Red: neither the failure mode nor the magnitude matched
- Black: the observed damage was obscured by smoke, fire, or other factors

The predominance of green dots and the scarcity of red dots indicate that the overall agreement with the observed damage was very good. The agreement for Cases B and D was slightly lower.

Assessment of the accuracy of the predictions of damage inside the buildings was more difficult, as NIST could not locate any interior photographs near the impact zones. Three comparisons were made:

- The Case A simulation for WTC 1 predicted that the walls of all three stairwells would have been collapsed. This agreed with the observations of the building occupants. The Case A simulation for WTC 2 showed that the walls of stairwell B would have been damaged, but that Stairwell A would have been unaffected. Stairwell C was not included in the WTC 2 model, but is adjacent to where damage occurred. The building occupants reported that Stairwells B and C were impassable; Stairwell A was damaged but passable.
- The two simulations of WTC 2 showed accumulations of furnishings and debris in the northeast corner of the 80th and 81st floors. These piles were observed in photographs and videos.
- Two pieces of landing gear penetrated WTC 1 and landed to the south of the tower. The Case B prediction showed landing gear penetrating the building core, but stopping before reaching the south exterior wall. For WTC 2, a landing gear fragment and the starboard engine penetrated the building and landed to the south. The Case D prediction correctly showed the main landing gear emerging from the northeast corner of WTC 2. However, Case D showed that engine not quite penetrating the building. Minor modifications to the model (all within the uncertainty of the input data) would have resulted in the engine passing through the north exterior wall of the tower.



(a) Observed Damage

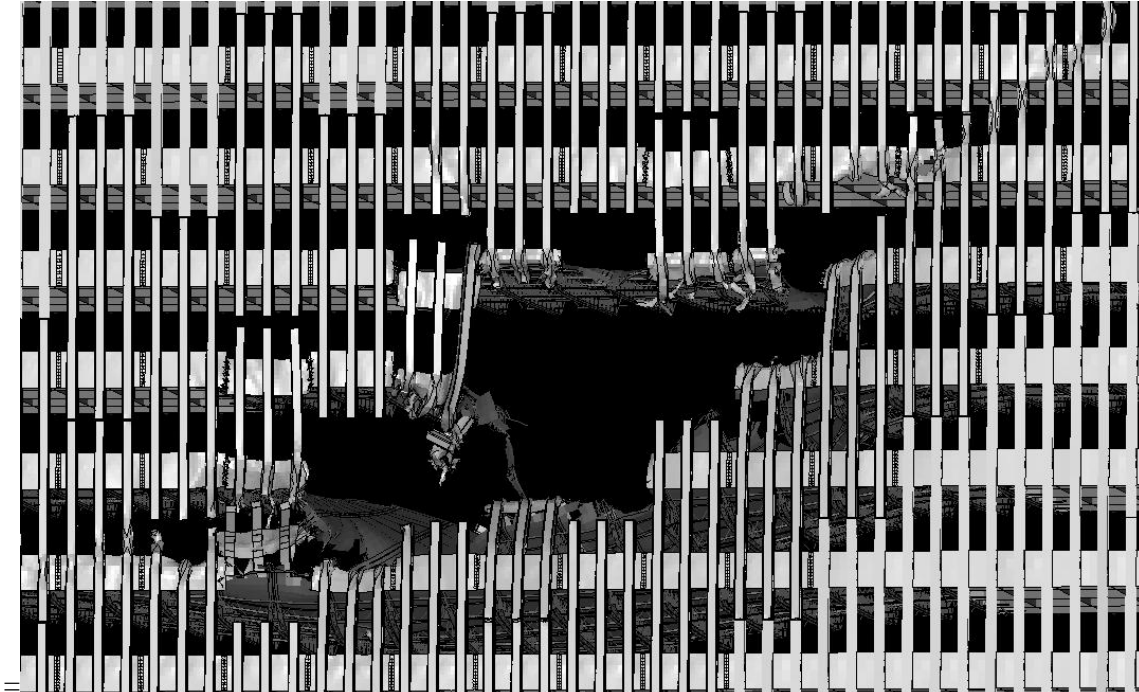

(b) Calculated damage

Figure 6–26. Observed and Case A calculated damage to the north face of WTC 1.

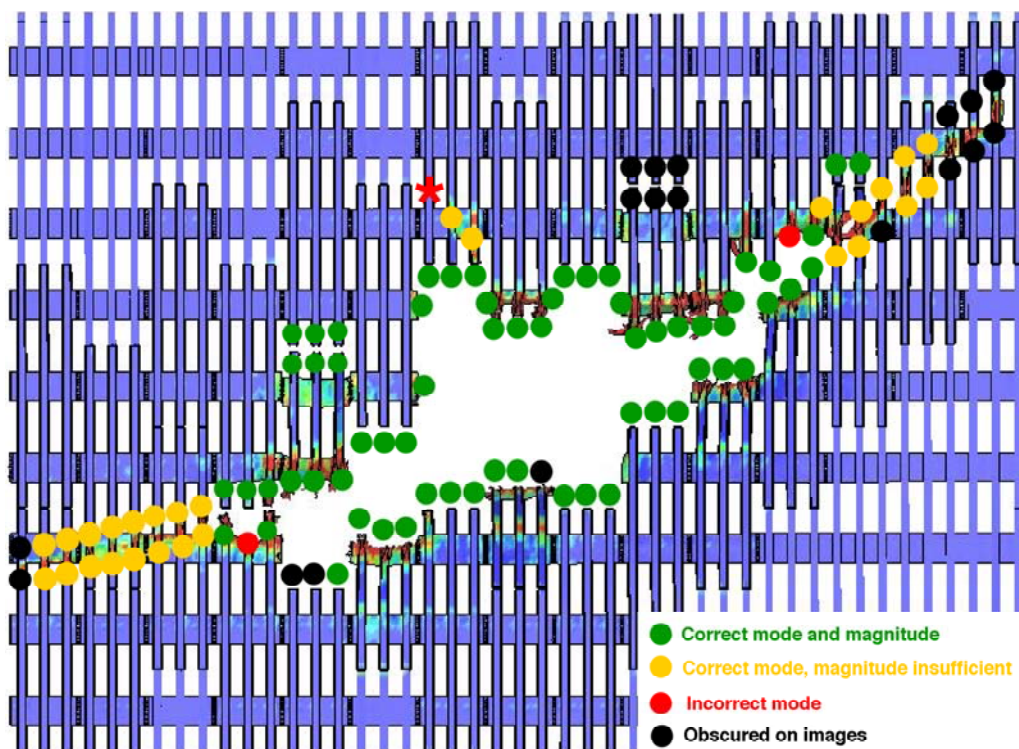
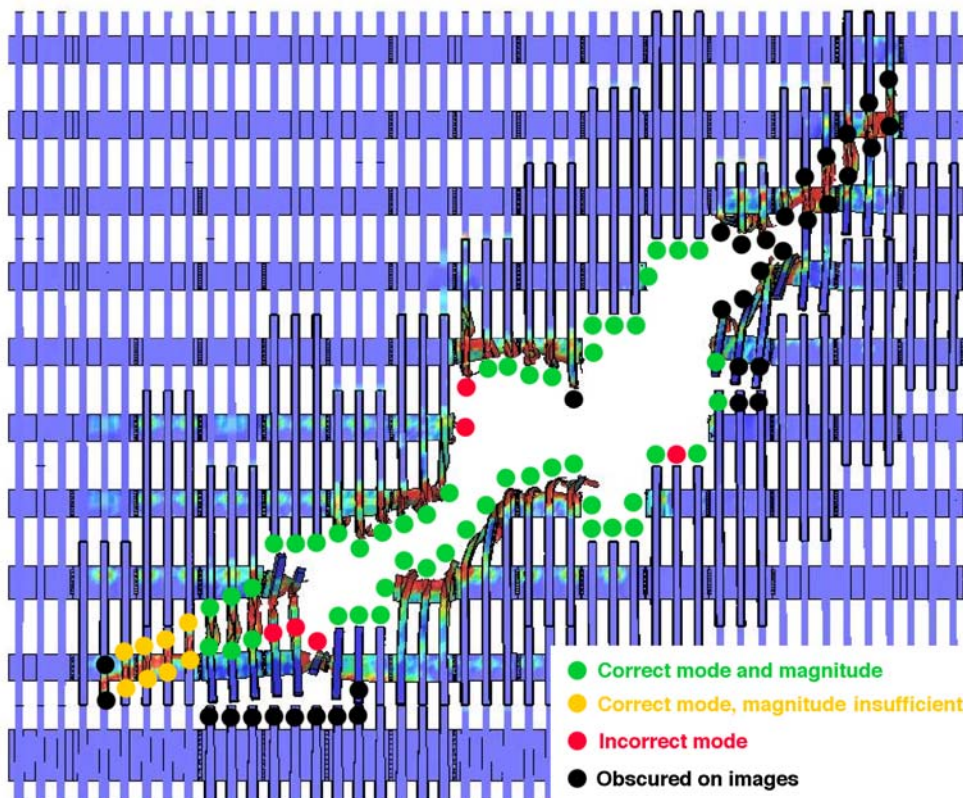

Figure 6–27. Schematic of observed damage (top) and Case A calculated damage (lower) to the north face of WTC 1.

- Correct mode and magnitude
- Correct mode, magnitude insufficient
- Incorrect mode
- Obscured on images

Figure 6–28. Schematic of observed damage (above) and Case C calculated damage (right) to the south face of WTC 2.



- Correct mode and magnitude
- Correct mode, magnitude insufficient
- Incorrect mode
- Obscured on images



Not all of the observables were closely matched by the simulations due to the uncertainties in exact impact conditions, the imperfect knowledge of the interior tower contents, the chaotic behavior of the aircraft breakup and subsequent debris motion, and the limitations of the models. In general, however, the results of the simulations matched these observables sufficiently well that the Investigation Team could rely on the predicted trends.

Simulations of the damage to the core columns had been performed previously by staff of Weidlinger Associates, Inc. (WAI) and the Massachusetts Institute of Technology (MIT). Each developed a range of numbers of failed and damaged columns, as did NIST. The range of the MIT results straddled the NIST results. WAI's analysis resulted in more failed and damaged columns, with WTC 2 being unstable immediately following impact.

### 6.9.3 Damage to Thermal Insulation

The dislodgement of thermal insulation from structural members could have occurred as a result of (a) direct impact by debris and (b) inertial forces due to vibration of structural members as a result of the aircraft impact. The debris from the aircraft impact included the fragments that were formed from both the aircraft (including the contents and fuel) and the building (structural members, walls, and furnishings). In interpreting the output of the aircraft impact simulations, NIST assumed that the debris impact dislodged insulation if the debris force was strong enough to break a gypsum board partition immediately in front of the structural component. Experiments at NIST confirmed that an array of 0.3 in. diameter pellets traveling at approximately 350 mph stripped the insulation from steel bars like those used in the WTC trusses.

Determining the adherence of SFRM outside the debris zones was more difficult. There was photographic evidence that some fraction of the SFRM was dislodged from perimeter columns not directly impacted by debris.

NIST developed a simple model to estimate the range of accelerations that might dislodge the SFRM from the structural steel components. As the SFRM in the towers was being upgraded with BLAZE-SHIELD II in the 1990s, The Port Authority had measured the insulation bond strength (force required to pull the insulation from the steel). The model used these data as input to some basic physics equations. The resulting ranges of accelerations depended on the geometry of the coated steel component and the SFRM thickness, density and bond strength. For a flat surface (as on the surface of a column), the range was from 20g to 530g, where g is the gravitational acceleration. For an encased bar (such as used in the WTC trusses), the range was from 40g to 730g. NIST estimated accelerations from the aircraft impacts of approximately 100g.

In determining the extent of insulation damage in each tower, NIST only assumed damage where dislodgement criteria could be established and supported through observations or analysis. Thus, NIST made the conservative assumption that insulation was removed only where direct debris impact occurred and did not include the possibility of insulation damage or dislodgement from structural vibration. This assumption produced a lower bound on the bared steel surface area, thereby making it more difficult to heat the steel to the point of failure.

#### 6.9.4 Damage to Ceiling System

The aircraft impact modeling did not include the ceiling tile systems. To estimate whether the tiles would survive the aircraft impact, the University at Buffalo, under contract to NIST, conducted tests of WTC-like ceiling tile systems using their shake table (Figure 6–29) and impulses related to those induced by the aircraft impact on the towers. The data indicated that accelerations of approximately 5g would most likely result in substantial displacement of ceiling tiles. Given the estimated impact accelerations of approximately 100g, NIST assumed that the ceiling tiles in the impact and fire zones were fully dislodged. This was consistent with the multiple reports of severely damaged ceilings (Chapter 7).

An intact ceiling tile system could have provided the floor trusses with approximately 10 min to 15 min of thermal protection from ceiling air temperatures near 1,000 °C. These temperatures would quickly heat steel without thermal insulation to temperatures for reduction of the strength of structural steels.

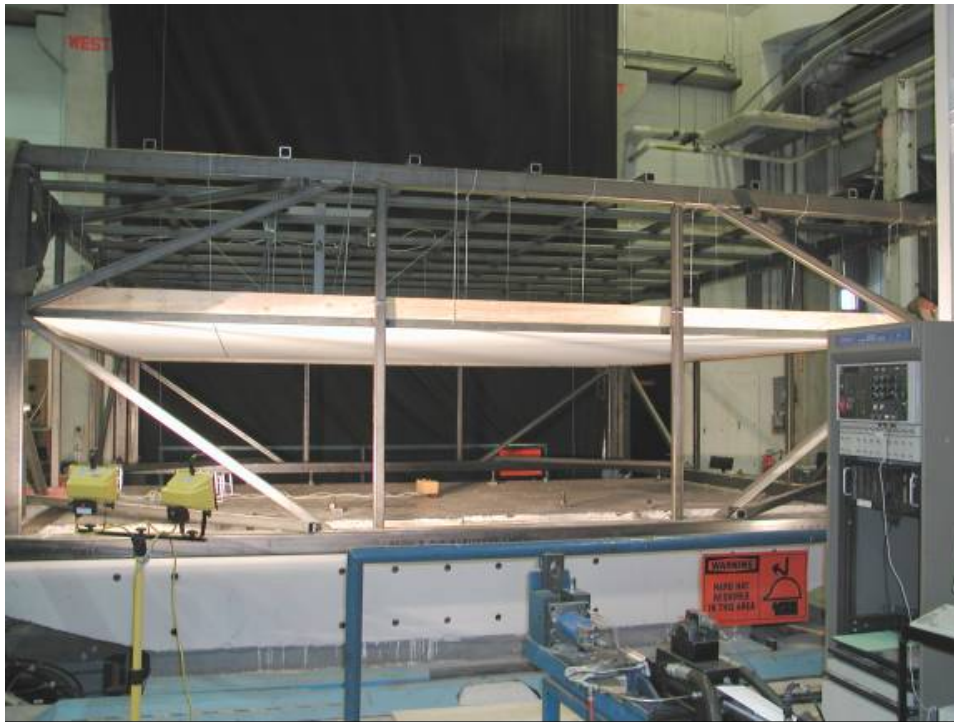

Source: NIST

Figure 6–29. Ceiling tile system mounted on the shaking table.

#### 6.9.5 Damage to Interior Walls and Furnishings

As shown in Figure 6–18, the aircraft impact simulations explicitly included the fracture of walls in the debris path and the “bulldozing” of furnishings. Damage to the impacted furnishings was not modeled. Walls and furnishings outside the debris paths were undamaged in the simulations.

## 6.10 THERMAL ENVIRONMENT MODELING

### 6.10.1 Need for Simulation

Following the impact of the aircraft, the jet-fuel-ignited fires created the sustained and elevated temperatures that heated the remaining building structure to the point of collapse initiation. The photographic evidence provided some information regarding the locations and spreading of the fires. However, the cameras could only see the periphery of the building interior. The steep viewing angles of nearly all of the photographs and videos further limited the depth of the building interior for which fire information could be obtained. NIST could not locate any photographic evidence regarding the fire exposure of the building core or the floor assemblies.

The simulations of the fires were the second computational step in the identification of the probable sequences leading to the collapse of the towers. The required output of these simulations was a set of three-dimensional, time varying renditions of the thermal and radiative environment to which the structural members in the towers were subjected from the time of aircraft impact until the onset of building collapse. The rigor of the Investigation placed certain requirements on the computational tool (model) used to generate these renditions:

- Resolution of the varying thermal environment across key dimensions, e.g., the truss space;
- Representation of the complex combustibles;
- Computation of flame spread across the large expanses of the WTC floors; and
- Confidence in the accuracy of the predictions.

### 6.10.2 Modeling Approach

The time frame of the Investigation and the above requirements led to the use of the Fire Dynamics Simulator (FDS). Under development at NIST since 1978, FDS was first publicly released in February 2000 and had been used worldwide on a wide variety of applications, ranging from sprinkler activation to residential and industrial fire reconstructions. However, it had never before been applied to spreading fires in a building with such large floor areas.

Figure 6–30 shows how FDS represented the eight modeled floors (92 through 99) of the undamaged WTC 1. A similar rendition was prepared for floors 78 through 83 of WTC 2. The layout of each floor was developed from architectural drawings and from the information described in Section 5.8. There was a wide range of confidence in the accuracy of these floor plans, varying from high (for the floors occupied by Marsh & McLennan in WTC 1, for which recent and detailed plans were obtained) to low (for most of the space in WTC 2 occupied by Fuji Bank, for which floor plans were not available).

The effects of the aircraft impact were derived from the simulations described in Section 6.8. The portions of walls and floors that were “broken” in those simulations were simply removed from the FDS models of the towers. The furnishings outside the aircraft-damaged regions were assumed to be unmoved and undamaged. The treatment of furnishings within the impact zone is discussed later in this section.

FDS represented the spaces in which the fires and their effluent were to be modeled as a grid of rectangular cells. These grids included the walls, floors, ceilings, and any other obstructions to the movement of air and fire. In the final simulations, the grid size was 0.5 m x 0.5 m x 0.4 m high (1.6 ft x 1.6 ft x 1.3 ft.). Each floor contained about 125,000 grid cells, and the nature of each cell was updated every 10 ms (100 times every second). The computations were performed using parallel processing, in which the fires on each floor were simulated on a different computer. At the end of each 10 ms update, the processors exchanged information and proceeded to the computations for the next time interval. Each simulation of 105 min of fires for WTC 1 took about a week on eight Xeon computers with a combined 16 GB of memory. The simulations for WTC 2, with fewer floors and 60 min of real time fires, took about half the time.

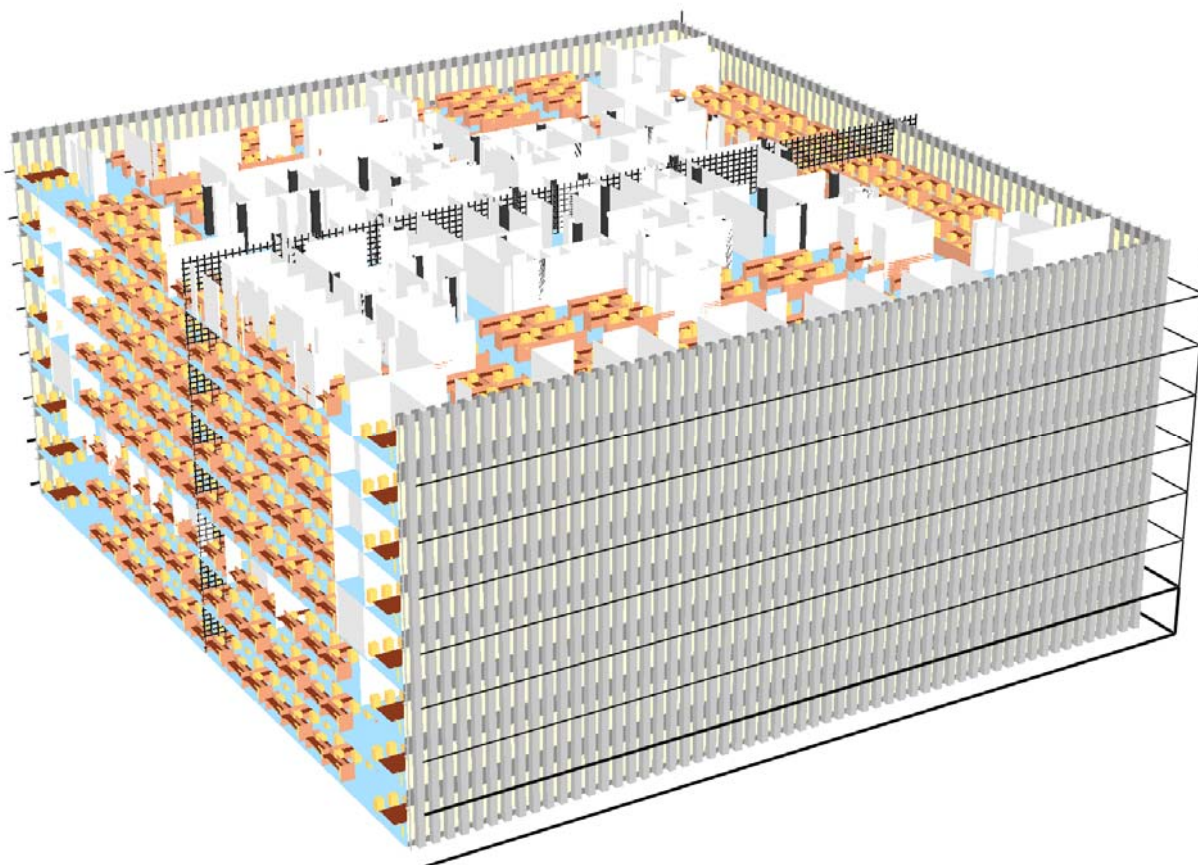

**Figure 6–30. Eight floor model of WTC 1 prior to aircraft impact.**

The fires were started by ignition of the jet fuel, whose distribution was provided by the aircraft impact simulations. The radiant energy from these short-lived fires heated the nearby combustibles, creating flammable vapors. When these mixed with air in the right proportion within a grid cell, FDS burned the mixture. This generated more energy, which heated the combustibles further, and continued the burning.

The floors of the tower on which the dominant burning occurred were characterized by large clusters of office workstations (Figure 1–11). NIST determined their combustion behavior from a series of single-workstation fire tests (Figure 6–31). In these highly instrumented tests, the effects of workstation type, the presence of jet fuel, and the presence of fallen inert material (such as pieces of ceiling tiles or gypsum board walls) on the burning surfaces were all assessed. While FDS properly captured the gross behavior of these fires, the state of modeling the combustion of real furnishings was still primitive. Thus, the results of this test series were used to refine the combustion module in FDS.



Source: NIST.

**Figure 6–31. Fire test of a single workstation.**

The accuracy of FDS predictions was then assessed using two different types of fire tests. In each case, the model predictions were generated prior to conducting the test.

The first series provided a measure of the ability of FDS to predict the thermal environment generated by a steady state fire. A spray burner generating 1.9 MW or 3.4 MW of power was ignited in a 23 ft by 11.8 ft by 12.5 ft high compartment. The temperatures near the ceiling approached 900 °C. FDS predicted:

- Room temperature increases near the ceiling to within 4 percent.
- Gas velocities at the air inlet to the compartment (and thus the air drawn into the compartment by the fire) within the uncertainty in the experimental measurements.
- The leaning of the fire plume due to the asymmetry of the objects within the compartment. The extent of the leaning was underestimated.
- Radiant heat flux near the ceiling to within 10 percent, within the uncertainty of the experimental measurements.

The large fires discussed in this report are characterized by heat release rate, or burning intensity, (in MW), by total energy released (in GJ), and by the heat flux, or radiant intensity (in kW/m<sup>2</sup>).

The second series was a preamble to the modeling of the actual WTC fires. Arrays of three WTC workstations were burned in a 35.5 ft by 23 ft by 11 ft high compartment (Figure 6–32). The tests examined the effects of the type of workstation, the presence of jet fuel, and the presence of fallen inert material on the burning surfaces. In one of the tests, the workstations were rubblized (Figure 6–33). Figure 6–34 depicts the intensity of the test fires. Figure 6–35 shows the measured and predicted heat release rate data from one of the tests in which there was no jet fuel nor inert material present.



**Figure 6–32. Interior view of a three-workstation fire test.**

Source: NIST.



**Figure 6–33. Rubblized workstations.**

Source: NIST.



Source: NIST

**Figure 6–34. Three-workstation fire test, 2 min after the start.**

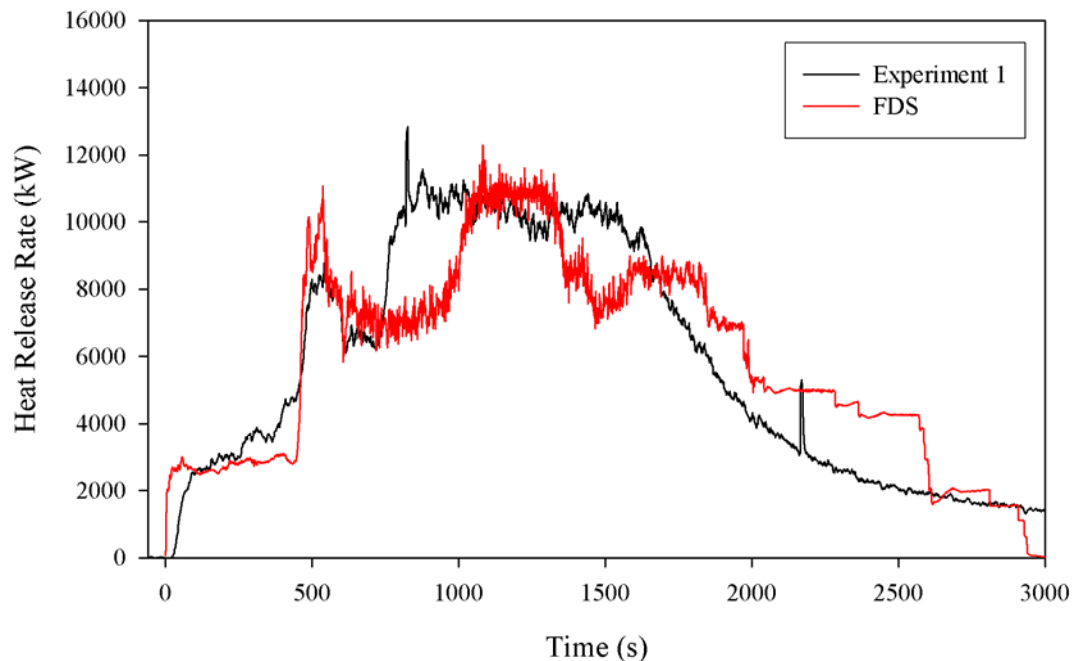

**Figure 6–35. Measured and predicted heat release rate from the burning of three office workstations.**

The differences in the fire behavior under the different experimental conditions were profound in these roughly hour-long tests. The jet fuel greatly accelerated the fire growth. Only about 60 percent of the

combustible mass of the rubblized workstations was consumed. The near-ceiling temperatures varied between 800 °C and 1,100 °C. Nonetheless, FDS successfully replicated:

- The general shape and magnitude of the time-dependent heat release rate.
- The time at which one half of the combustion energy was released to within 3 min.
- The value of the heat release rate at this time to within 9 percent.
- The duration of the fires to within 6 min.
- The peak near-ceiling temperature rise to within 10 percent.

All these predictions were within the combined uncertainty in the model input data and the experimental measurements.

Combined, these results led to the assessment that the uncertainty in the thermal environment predictions of the WTC fires would be dominated less by the FDS errors and more by the unknowns in such factors as the distribution of the combustibles, ventilation, and building damage.

### 6.10.3 The Four Cases

Four fire scenarios (Case A and Case B for WTC 1 and Case C and Case D for WTC 2) were superimposed on the four cases of aircraft-driven damage of the same names (Section 6.9).

A number of preliminary simulations had been performed to gain insight into the factors having the most influence on the severity of the fires. The most influential was the mass of combustibles per unit of floor area (fuel load); second was the extent of core wall damage, which affected the air supply for the fires. The aforementioned workstation fire tests had also indicated that the damage condition of the furnishings also played a key role. The scenario variables and their values are shown in Table 6–6.

**Table 6–6. Values of WTC fire simulation variables.**

Variable	WTC 1		WTC 2	
	Case A	Case B	Case C	Case D
Tenant combustible fuel load <sup>a</sup>	4 lb/ft <sup>2</sup>	5 lb/ft <sup>2</sup>	4 lb/ft <sup>2</sup>	5 lb/ft <sup>2</sup>
Distribution of disturbed combustibles	Even	Weighted toward the core	Heavily concentrated in the northeast corner	Moderately concentrated in the northeast corner
Condition of combustibles	Undamaged except in impact zone	Displaced furniture rubblized	All rubblized	Undamaged except in impact zone
Representation of impacted core walls <sup>b</sup>	Fully removed	Soffit remained	Fully removed	Soffit remained

a. In addition, approximately 27,000 lb of solid combustibles from the aircraft were distributed along the debris path.

b. In Cases A and C, the walls impacted by the debris field were fully removed. This enabled rapid venting of the upper layer into the core shafts and reduced the burning rate of combustibles in the tenant spaces. In Cases B and D, a more severe representation of the damage was to leave a 4 ft gypsum wallboard soffit that would maintain a hot upper layer on each fire floor. This produced a fire of longer duration near the core columns and the attached floor membranes.



FDS contained no algorithm for breaking windows from the heat of the fires. Thus, during each simulation, windows were removed at times when photographs indicated they were first missing. Damage to the ventilation shafts was derived from the aircraft impact simulations. For undamaged floors, all the openings to the core area were assumed to total about 50 ft<sup>2</sup> in area.

#### 6.10.4 Characterization of the Fires

For each of the four scenarios, FDS was used to generate a time-dependent gas temperature and radiation environment on each of the floors. The results of the FDS simulations of the perimeter fire were compared with the fire duration and spread rate as seen in the photographs and videos. For ease of visualization, contour plots of the room gas temperature 1.3 ft below the ceiling slab (in the “upper layer” of the compartment) were superimposed on profiles of the photographed fire activity. An example is shown in Figure 6–36. The stripes surrounding the image represent a summary of the visual observations of the windows, with the black stripes denoting broken windows, the orange stripes denoting external flaming, and the yellow stripes denoting fires that were seen inside the building. Fires deeper than a few meters inside the building could not be seen because of the smoke obscuration and the steep viewing angle of nearly all the photographs.

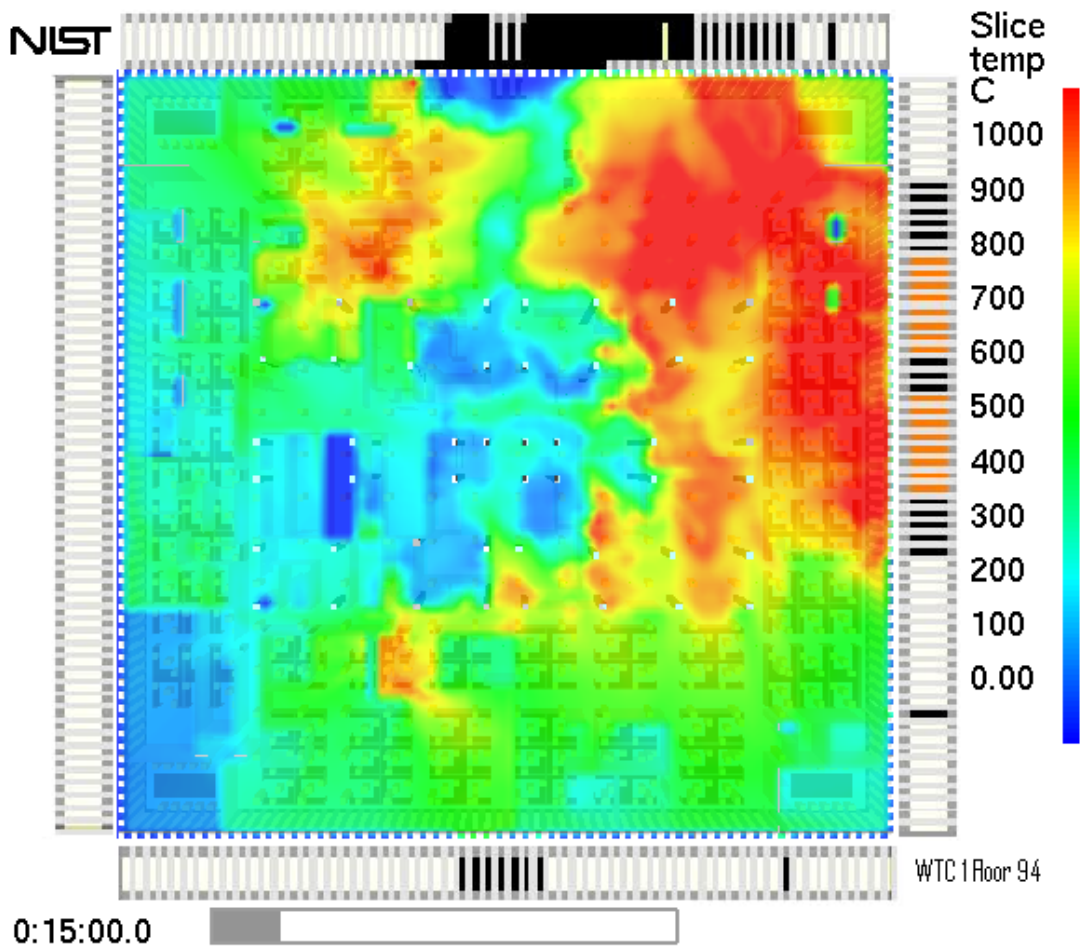

Figure 6–36. Upper layer temperatures on the 94<sup>th</sup> floor of WTC 1, 15 min after impact.

Given the uncertainties in some of the floor plans, the damage to the internal walls, and movement of the office furnishings, the intent of the simulations was to capture the magnitudes of the fires and the broad features of their locations and movement; and they did so.

The following sections summarize the simulated behavior of the fires (which was used in the following stages of the disaster reconstruction) and their correlation with the analysis of the photographic evidence.

### WTC 1

Much of the fire activity was initially in the vicinity of the impact area in the north part of the building. As a result of the orientation of the impacting aircraft and its fuel tanks, the early fires on the 92<sup>nd</sup> through 94<sup>th</sup> floors tended toward the east side of the north face, while the early fires on the 97<sup>th</sup> through 99<sup>th</sup> floors tended toward the west side of the north face. The fires on all the floors spread along the east and west sides and were concentrated in the south part of the building at the time of collapse, as depicted in Figure 6–37.

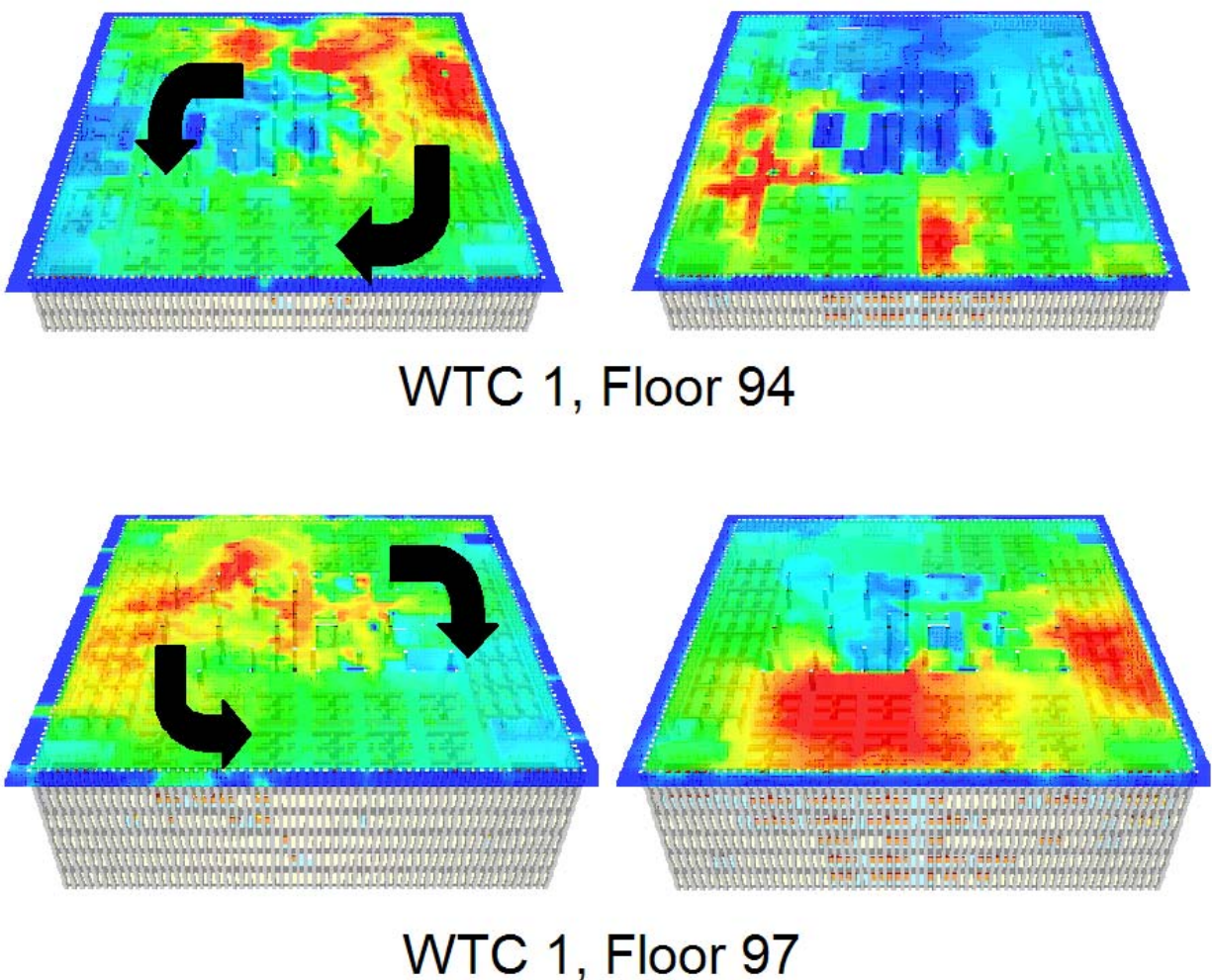

Figure 6–37. Direction of simulated fire movement on floors 94 and 97 of WTC 1.

The fire simulation results for Case A and Case B were similar, indicating only a modest sensitivity to the fuel load and the degree of aircraft-generated damage. This was because, in general, the size and movement of the fires in WTC 1 were limited by the supply of air from the exterior windows. Since the window breakage pattern was not changed in Case B, the additional and re-distributed combustibles within the building did not contribute to a *larger* fire. The added fuel did slow the spread slightly because the fires were sustained longer in any given location.

Although there was generally reasonable agreement between the simulated and observed fire spread rates, there were instances where the fires burned too quickly and too near the windows. This resulted from an artifact of the model: the combustible vapors burned immediately upon mixing with the incoming oxygen.

Simulations performed with doubled fuel loads slowed the fire spread well below the observed rates. Combined with the above results, this suggested that the estimated overall combustible load of 4 lb/ft<sup>2</sup> was reasonable.

The simulations showed high temperatures in some of the elevator shafts. The late fire observed on the west face of the 104<sup>th</sup> floor may have started from fuel gases in the core shafts that had accumulated over the course of the first hour of fires below. The presence of fire in the shafts on the 99<sup>th</sup> floor provided some support for this hypothesis, but no simulations were performed for floors higher than the 99<sup>th</sup>.

The predictions of maximum temperatures (e.g., red zones in Figure 6–37) were consistent with those in the three-workstation fire tests.

The use of an “average” gas temperature was not a satisfactory means of assessing the thermal environment on floors this large and would also have led to large errors in the subsequent thermal and structural analyses. The heat transferred to the structural components was largely by means of thermal radiation, whose intensity is proportional to the fourth power of the gas temperature. At any given location, the duration of temperatures near 1,000 °C was about 15 min to 20 min. The rest of the time, the calculated temperatures were near 500 °C or below. To put this in perspective, the radiative intensity onto a truss surrounded by smoke-laden gases at 1,000 °C was approximately 7 times the value for gases at 500 °C.

## WTC 2

Simulating the fires in WTC 2 posed challenges in addition to those encountered in simulating the fires in WTC 1. The aircraft, hitting the tower to the east of center, splintered much of the furnishings on the east side of the building and plowed them toward the northeast corner. Neither the impact study nor the validation experiments performed at NIST could be completely relied upon to predict the final distribution, condition, and burning behavior of the demolished furnishings. In addition, only the layouts of the 78<sup>th</sup> and 80<sup>th</sup> floors were available to the Investigation; the other floors were only roughly described by former occupants. As a result of these unknowns, the uncertainty in these calculations was distinctly greater than in those for WTC 1. To help mitigate gross differences between the simulations and the observables, NIST made floor-specific adjustments, based on the results of preliminary computations. In particular, the fuel load and volatility on the 80<sup>th</sup> floor were reduced, and the fuel load on the 81<sup>st</sup> and 82<sup>nd</sup> floors was increased.

In contrast with WTC 1, in WTC 2 there was less movement of the fires. The major burning occurred along the east side, with some spread to the north. There was no significant burning on the west side of the tower.

Also unlike WTC 1, changing the combustible load in WTC 2 had a noticeable effect on the outcome of the simulations. Because so many windows on the impact floors in WTC 2 were broken out by the aircraft debris and the ensuing fireballs, there was an adequate supply of air for the fires. Thus, the burning rate of the fires was determined by the fuel supply. In the Case D simulation, the office furnishings and aircraft debris were spread out over a wider area, and the furnishings away from the impact area were undamaged. Both of these factors enabled a higher burning rate for the combustibles.

In general, the Case D simulations more closely approximated the observations in the photographs and videos, although there was still some prediction of burning too close to the perimeter, especially on the east side of the 78<sup>th</sup>, 79<sup>th</sup>, 81<sup>st</sup> and 83<sup>rd</sup> floors. The burning in the northeast corner of the 81<sup>st</sup> and 82<sup>nd</sup> floors was more intense in Case D than in Case C. The fire in the east side of the 79<sup>th</sup> floor burned more intensely and reached the south face sooner.

Nothing in the simulations explained the absence of fires in the “cold spot,” the 10-window expanse toward the east of the north face of the 80<sup>th</sup>, 81<sup>st</sup>, and 82<sup>nd</sup> floors.

### 6.10.5 Global Heat Release Rates

Much of the information needed to simulate the fires came from laboratory-scale tests. While some of these involved enclosures several meters in dimension and fires that reached heat release rates of 10 MW and 12 GJ in total heat output, they were still far smaller than the fires that burned in the WTC towers. Figure 6–38 shows the heat release rates from the FDS simulations of the WTC fires. The peak plateau heat release rates were about 2 GW for WTC 1 and 1 GW for WTC 2. Integrating the areas under these curves produced total heat outputs from the simulated fires of about 8,000 GJ from WTC 1 and 3,000 GJ from WTC 2.

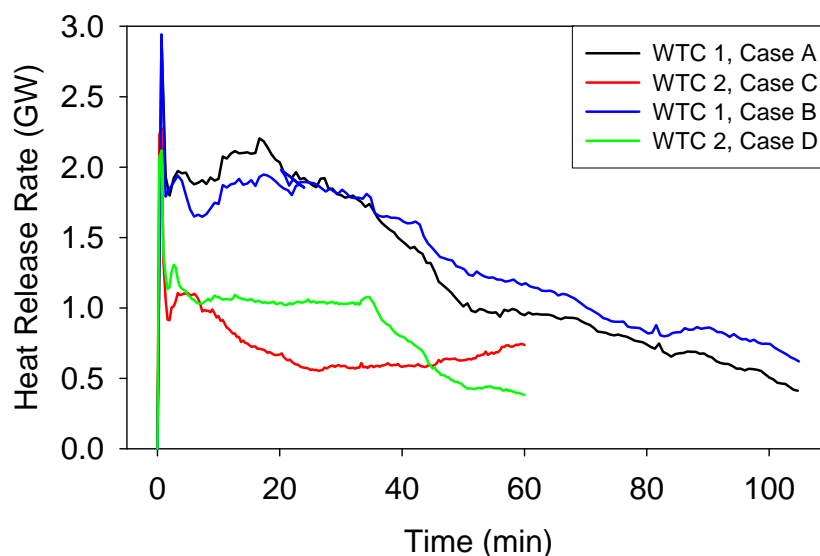

Figure 6–38. Predicted heat release rates for fires in WTC 1 and WTC 2.

## 6.11 DATA TRANSFER

The following data from FDS were compiled for use as boundary conditions for the finite-element calculation of the structural temperatures:

- The upper and lower layer gas temperatures, time-averaged over 100 s and spatially averaged over 3 ft. The upper layer gas temperatures were taken 1.3 ft (one grid cell) below the ceiling. The lower layer temperatures were taken 1.3 ft above the floor.
- The depth of the smoke layer.
- The absorption coefficient of the smoke layer 1.3 ft below the ceiling.

## 6.12 THERMAL MAPPING

### 6.12.1 Approach

Simulating the effect of a fire on the structural integrity of a building required a means for transferring the heat generated by the fire to the surfaces of the insulation on structural members and then conducting the heat through those members. In the Investigation, this meant mapping the time- and space-varying gas temperatures and radiation field generated by FDS onto and throughout the (insulated) columns, trusses and other elements that made up the tower structure.

This process was made difficult for these large, geometrically complex buildings by the wide disparity in length and time scales that had to be accounted for in the simulations. FDS generated thermal maps with dimensional resolution of the order of a meter and temperatures fluctuating on a time scale of milliseconds. The finite element models for thermal analysis resolved length of the order of ½ in. on a time scale of seconds. Devising a computation scheme to accommodate the finest of these scales, while simulating the largest of these scales, presented a software challenge in order to avoid unacceptably long computation times.

### 6.12.2 The Fire-Structure Interface

NIST developed a computational scheme to overcome this difficulty, the Fire Structure Interface (FSI).

These computations began with the structural models of each WTC tower as described in Section 6.6.4, damaged by the aircraft as described in Section 6.8.4 and exposed to fire-generated heat, as described in Section 6.10.4. For a particular tower and damage scenario, FSI “bathed” each small section of each structural member in an air environment that had been generated by FDS. For efficiency of computation, two simplifications were made:

- The fluctuating environment was averaged over 30 s intervals, and

The transfer of radiant energy from a hot mass to a cool mass is proportional to the absolute temperature (Kelvin) to the fourth power. Thus, the contribution of the hot upper layer dominates the overall radiative heat transfer. Convective heat transfer is linearly proportional to the difference in temperature between the hot gas and the cool solid.

- The local environment was represented by a hot, soot-laden upper layer and a cooler, relatively clear lower layer.

FSI then calculated the radiative and convective heat transfer to each of these small sections using conventional physics. Finally, the temperature data were read into the ANSYS 8.0 finite element program, which applied the temperature distribution to the structural elements.

### **6.12.3 Thermal Insulation Properties**

#### **Equivalent Uniform Thickness of SFRM**

Preliminary simulations with FSI explored the extent to which bare steel structural elements would heat more rapidly than the same elements would if they were well insulated. In one such calculation experiment, one of the largest columns in the tower structure was immersed in a furnace at 1,100 °C. Uninsulated, it took just 13 min for the steel surface temperatures to reach 600 °C, in the range where substantial loss of strength occurs. When insulated with 1 1/8 in. of SFRM, the same column had not reached that temperature in 10 hours. This established that the fires in WTC 1 and WTC 2 would not be able to significantly weaken the insulated core or perimeter columns within the 102 min and 56 min, respectively, after impact and prior to collapse. Thus, it was important to know whether the insulation was present or removed and much less important to know the exact thickness of the SFRM.

It was likely that the thinner steel bars and angles in the floor trusses would be more sensitive to the condition of the insulation. If the insulation were present, but too thin or imperfectly applied, these components might have been heated to failure in times on the order of an hour.

NIST performed additional simulations to probe the effect of gaps in the truss insulation and of variations in the thickness, similar to those observed in real SFRM application (Figure 5–6). It was evident that incorporation of these small-scale variations into the description of the structural members would have lengthened the FSI computations to an extreme. Furthermore, there was insufficient information to determine how the thickness varied over the length of the structural members. NIST combined the measured variations in the SFRM thickness (as described in Section 5.6.2) with simulations of the heat transfer through the uneven material. This led to the identification of a uniform thickness that provided the same insulation value as did the measured coatings. These values, shown in Table 5–3, were used in the thermal calculations. They were found to be greater than the specified thicknesses but slightly smaller than the average measured thicknesses, as they should be.

#### **SFRM Thermophysical Properties**

When the Investigation began, there were few published data on the insulating properties of SFRMs, especially at elevated temperatures. It was expected, and soon confirmed, that the fires could generate temperatures up to 1,100 °C. Therefore, NIST contracted for measurement of the key SFRM thermophysical properties that, along with coating thickness, determine the insulating effect of the coatings. These properties included thermal conductivity, specific heat capacity, and density. These were measured for each SFRM at temperatures up to 1,200 °C. Since there were no ASTM test methods developed specifically for characterizing the thermophysical properties of SFRMs as a function of temperature, ASTM test methods developed for other materials were used. Samples were prepared by the

manufacturers of the fire-resistive material, which included BLAZE-SHIELD DC/F and BLAZE-SHIELD II.

- The thermal conductivity measurements were performed according to ASTM C 1113, Standard Test Method for Thermal Conductivity of Refractories by Hot Wire (Platinum Resistance Thermometer Technique). The room temperature values were in general agreement with the manufacturer's published values for both materials. The thermal conductivities increased with temperature.
- Specific heat capacity was measured in accordance with ASTM E 1269, Standard Test Method for Determining Specific Heat Capacity by Differential Scanning Calorimetry (DSC). By including DSC measurement of a NIST Reference Material (sapphire), the measured SFRM quantities were directly traceable to NIST standards.
- The densities of the SFRMs were calculated from measurements of changes in the mass and dimensions of samples as their temperatures were increased. The length-change measurements were performed according to ASTM E 228, Standard Test Method for Linear Thermal Expansion of Solid Materials. The mass loss measurements were performed according to ASTM E 1131, Standard Test Method for Compositional Analysis by Thermogravimetry.

It was not known which type(s) of gypsum wallboard were used to enclose the core columns. Therefore, the thermophysical properties of four types of gypsum panels were examined.

- Thermal conductivity was measured using the heated probe technique described in ASTM D 5334, Standard Test Method for Determination of Thermal Conductivity of Soil and Soft Rock by Thermal Needle Probe Procedure. In general, the thermal conductivity initially decreased as the temperature increased to 200 °C and then increased with increasing temperature above 300 °C.
- Specific heat capacities of the cores of the four gypsum panel samples were measured using a differential scanning calorimeter at NIST according to ASTM E 1269, Standard Test Method for Determining Specific Heat Capacity by Differential Scanning Calorimetry. The four panels had nearly identical specific heat capacities as a function of temperature.
- The variation of density with temperature was determined from the change in volume of the gypsum material and the mass loss. The linear expansion was determined using a dilatometer and the mass loss from thermogravimetric analysis. All four materials showed the same trend as a function of temperature.

#### 6.12.4 FSI Uncertainty Assessment

As was done for FDS, it was necessary to establish the quality of FSI's predictions of temperature profiles within insulated and bare structural steel components. This was accomplished using data from a series of six tests in which assorted steel members were exposed to controlled fires of varying heat release rate and radiative intensity. The steel members, depicted in Figures 6–39 through 6–41, were either bare or coated with sprayed BLAZE-SHIELD DC/F in two thicknesses. The fibrous insulation was applied by an

experienced applicator, who took considerable care to apply an even coating of the specified thickness. As such, the insulated test subjects represent a best case in terms of thickness and uniformity. Figure 6–42 shows some of the coated components.

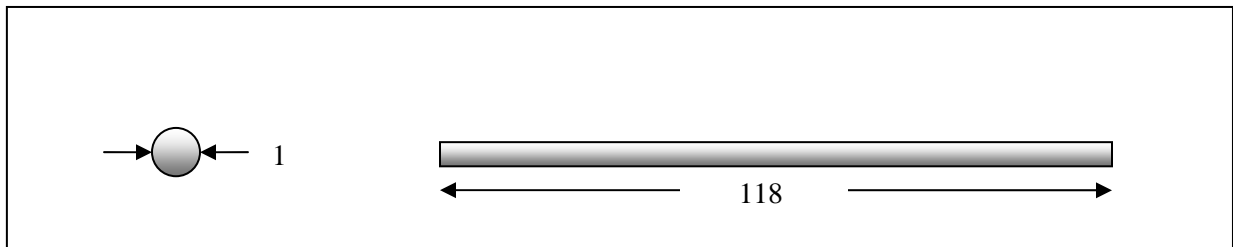

Figure 6–39. Simple bar dimensions (in.).

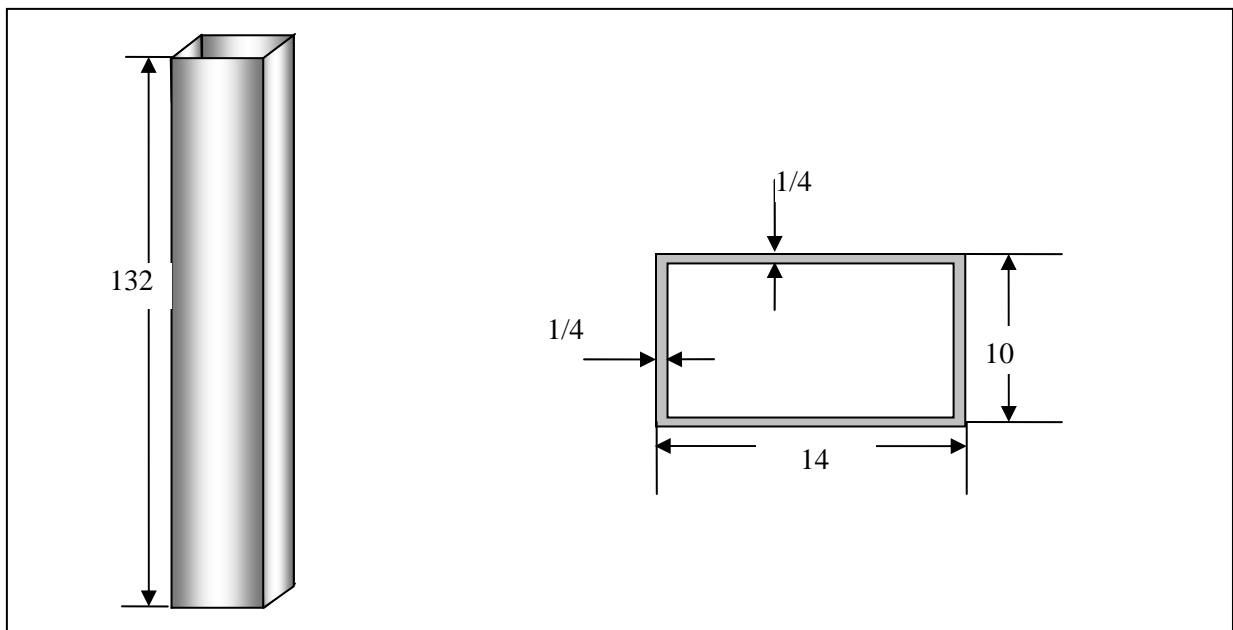

Figure 6–40. Tubular column dimensions (in.).



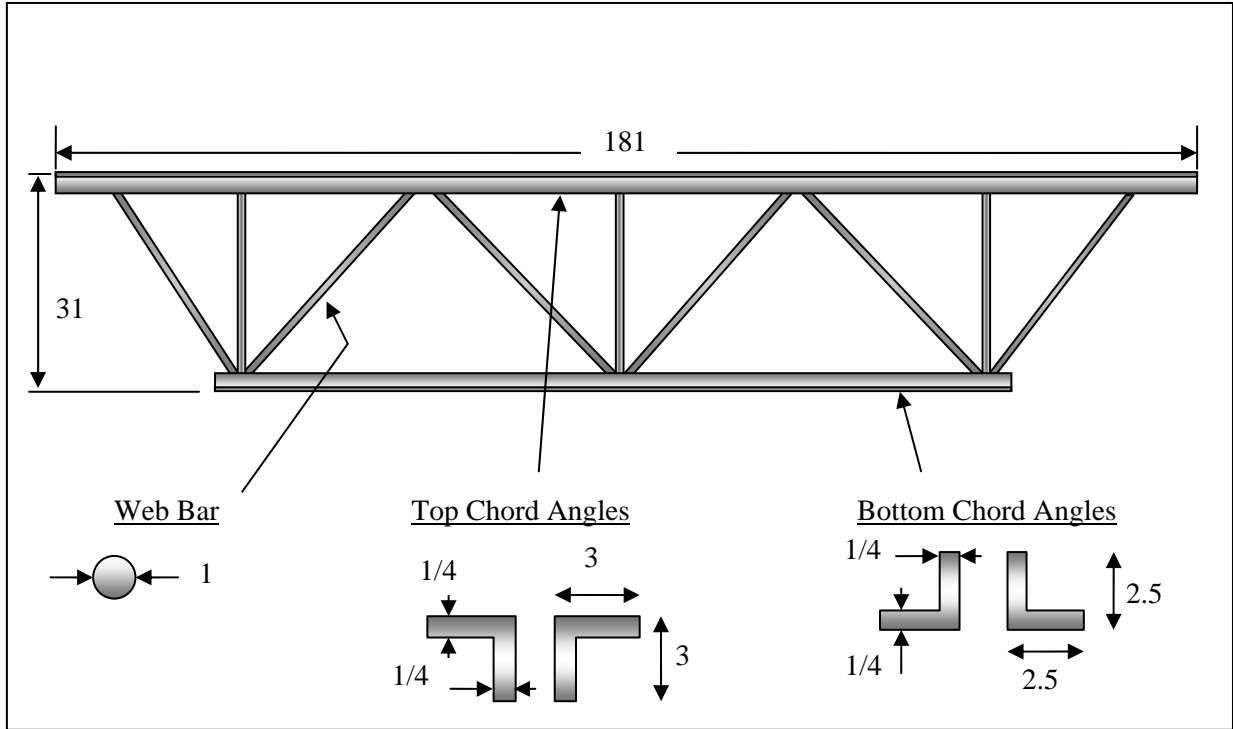

Figure 6-41. Truss Dimensions (in.).



Source: NIST.

Figure 6-42. SFRM-coated steel components prior to a test.

Table 6–7 shows the dimensions and variability of the insulation for the two successful tests involving coated steel. The thickness measurements were taken at numerous locations along the perimeter and length of each specimen using a pin thickness gauge specifically designed for this type of insulation.

**Table 6–7. Summary of insulation on steel components.**

Test	Item	Specified Thickness (in.)	Applied Thickness (in.)	
			Mean	Std. Deviation
5	Bar	0.75	0.91	0.22
	Column	1.50	1.61	0.12
	Truss A	0.75	1.06	0.28
	Truss B	1.50	1.59	0.32
6	Bar	0.75	1.00	0.18
	Column	0.75	0.84	0.14
	Truss A	0.75	1.02	0.27
	Truss B	0.75	1.01	0.27

Temperatures were recorded at multiple locations on the surfaces of the steel, the insulation, and the compartment. As an example, Figure 6–43 shows the finite element representation of the coated truss.

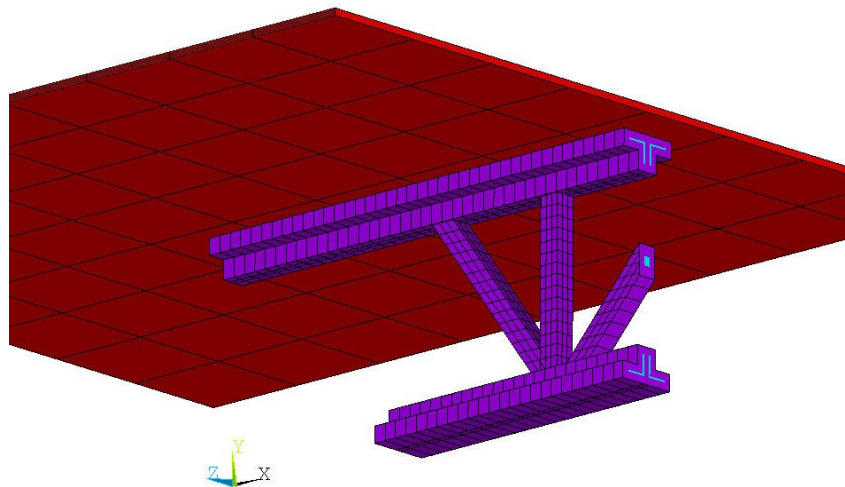

**Figure 6–43. Finite element representation of the insulated steel truss (blue), the SFRM (violet), and the ceiling (red).**

Figure 6–44 compares the measured and predicted temperatures on the steel surface of the top chord of a bare truss. Figure 6–45 is the analogous plot of the measured and predicted temperatures on the steel surface of the top chord of a truss insulated with 3/4 in. of BLAZE-SHIELD DC/F. Similar curves were generated for each of the steel pieces, bare and insulated.

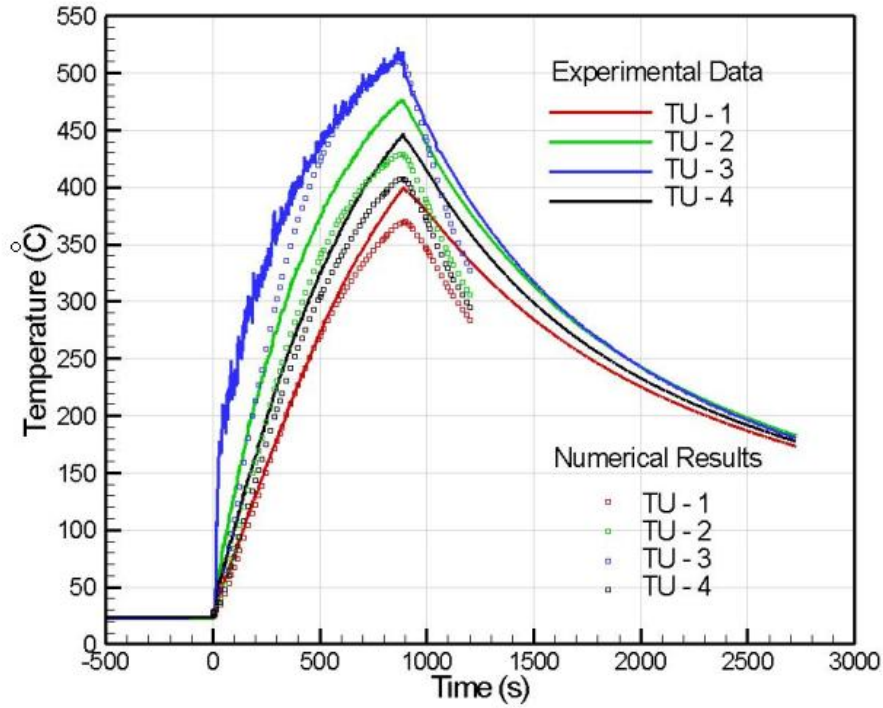

Figure 6-44. Comparison of numerical simulations with measurements for the steel surface temperature at four locations on the top chord of a bare truss.

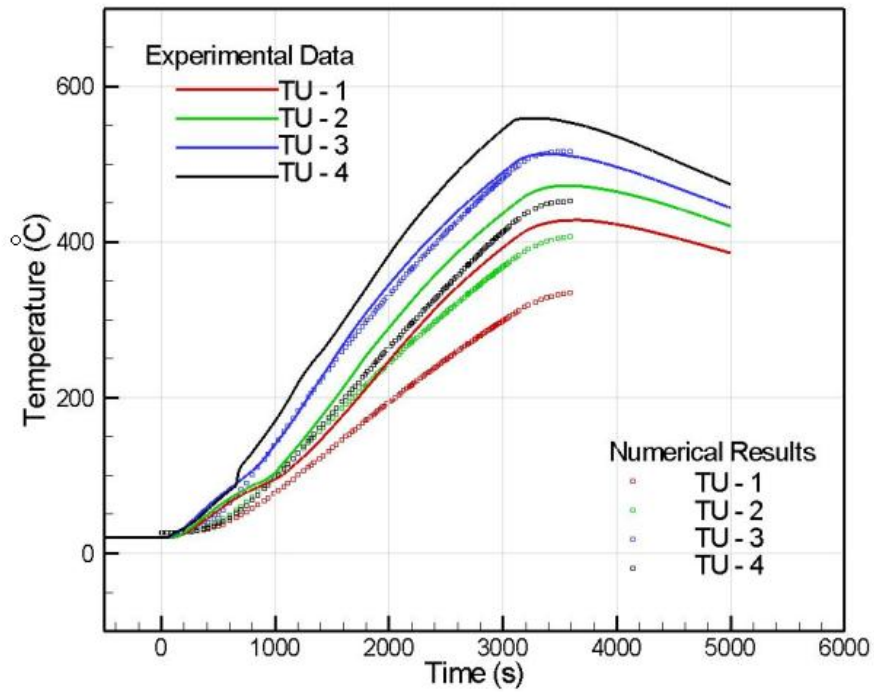

Figure 6-45. Comparison of numerical simulations with measurements for the temperature of the steel surface at four locations on the top chord of an insulated truss.

Examination of the graphs for the insulated steel pieces indicated the following:

- FSI captured the shape of the temperature rise at the steel surfaces and the significant decrease in the rate of temperature rise when the SFRM was present.
- The times to the peak temperature (or a near-plateau) were predicted to within about a minute in all cases.
- There was no consistent pattern of overprediction or underprediction of the surface temperatures.
- On the average, the numerical predictions of the steel surface temperature were within 7 percent of the experimental measurements for bare steel elements and within 17 percent for the insulated steel elements. The former was within the combined uncertainty in the temperature measurements and the heat release rate in the fire model. The increase in the latter was attributed to model sensitivity to the SFRM coating thickness and thermal conductivity.

In general, the FSI added little to the overall uncertainty in the simulation of the temperatures at the outer surfaces of bare steel elements and, more importantly, at the SFRM-steel interface.

An additional, important outcome of the experiments was the demonstration of the insulating effect of even 3/4 in. of SFRM. Trusses, made of relatively thin steel, were far more susceptible to heating than the perimeter and core columns. As shown in Figure 2–10, in 15 min, a bare truss reached a temperature at which significant loss of strength was imminent. An identical, but insulated truss had not reached that temperature in 50 min.

#### **6.12.5 The Four Cases**

FSI imposed the thermal environment from each of the four FDS fire scenarios (Cases A and B for WTC 1 and Cases C and D for WTC 2) on the four damaged structures from the aircraft simulations, which carried the same case letters. The FSI output files carried the same case letters as the input files.

The FSI calculations were performed at time steps ranging from 1 ms to 50 ms. Use of the resulting data set for structural analysis would have required a prohibitive amount of computation time. Thus, for each case, the instantaneous temperature and temperature gradient for each grid volume was provided at 10 min intervals after aircraft impact. For WTC 1, there were 10 such intervals, ending at 6,000 s; for WTC 2 there were 6 intervals, ending at 3,600 s. Comparison of these coarsely timed output files with files at 1 min resolution showed any differences to be within the combined uncertainty.

Each floor in the FSI simulation provided thermal information for the floor assembly above. Thus, there was not sufficient information for FSI to model the lowest floor in the FDS simulations. For WTC 1, the global thermal response generated by FSI included floors 93 through 99; for WTC 2, the included floors were 79 through 83.

For ease of visualization, two graphic representations were developed. Figure 6–46 shows an example of the temperature map for the 96<sup>th</sup> floor of WTC 1. Severed columns and broken floor segments are not shown. Figure 6–47 shows a similar map for the 81<sup>st</sup> floor of WTC 2.

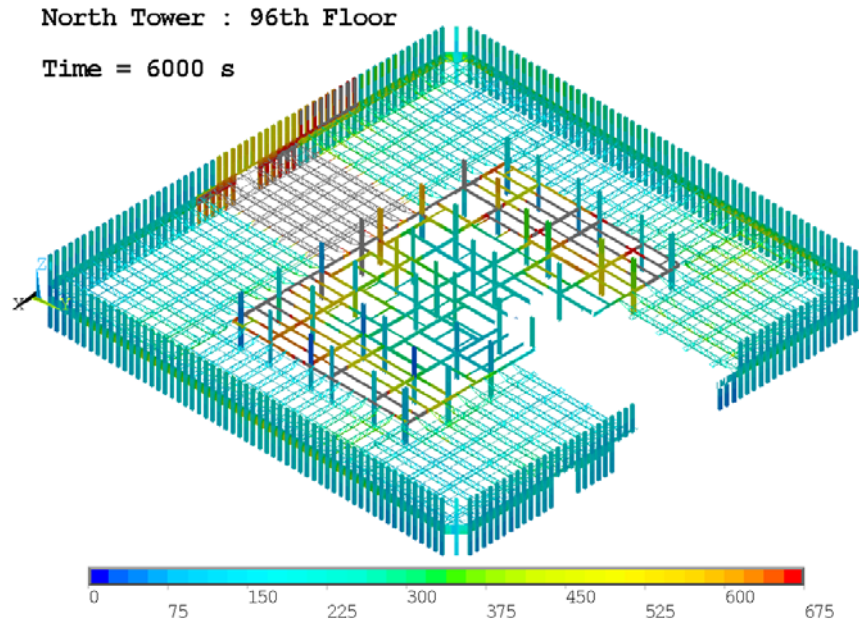

**Figure 6–46. Temperatures (°C) on the columns and trusses of the 96<sup>th</sup> floor of WTC 1 at 6,000 s after aircraft impact, Case B.**

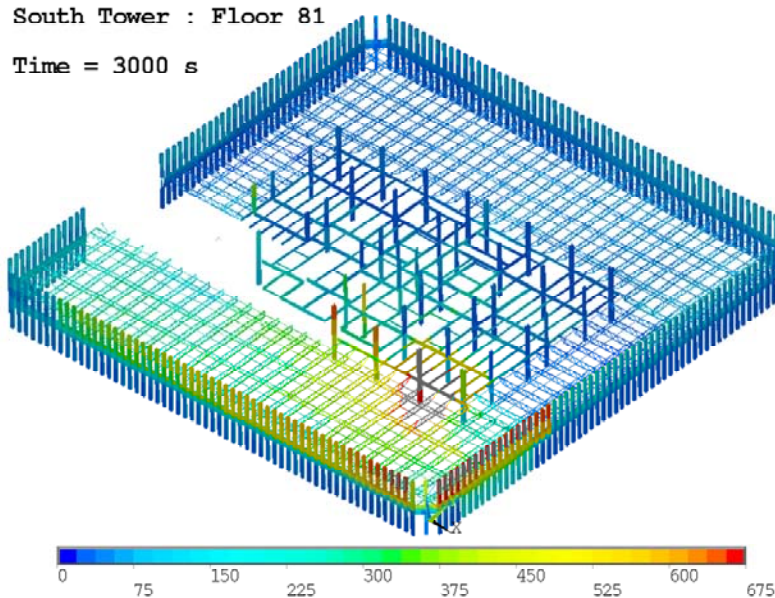

**Figure 6–47. Temperatures (°C) on the columns and trusses of the 81<sup>st</sup> floor of WTC 2 at 3,000 s after aircraft impact, Case D.**

A third visualization tool was animation of the evolving temperatures of the columns. Frames from an example, again of the 96<sup>th</sup> floor of WTC 1, Case A, are shown in Figure 6–48. The size of the square representing a column represents its yield strength. Columns may have been heated when the fire was nearby and then cooled after the local combustibles were consumed.

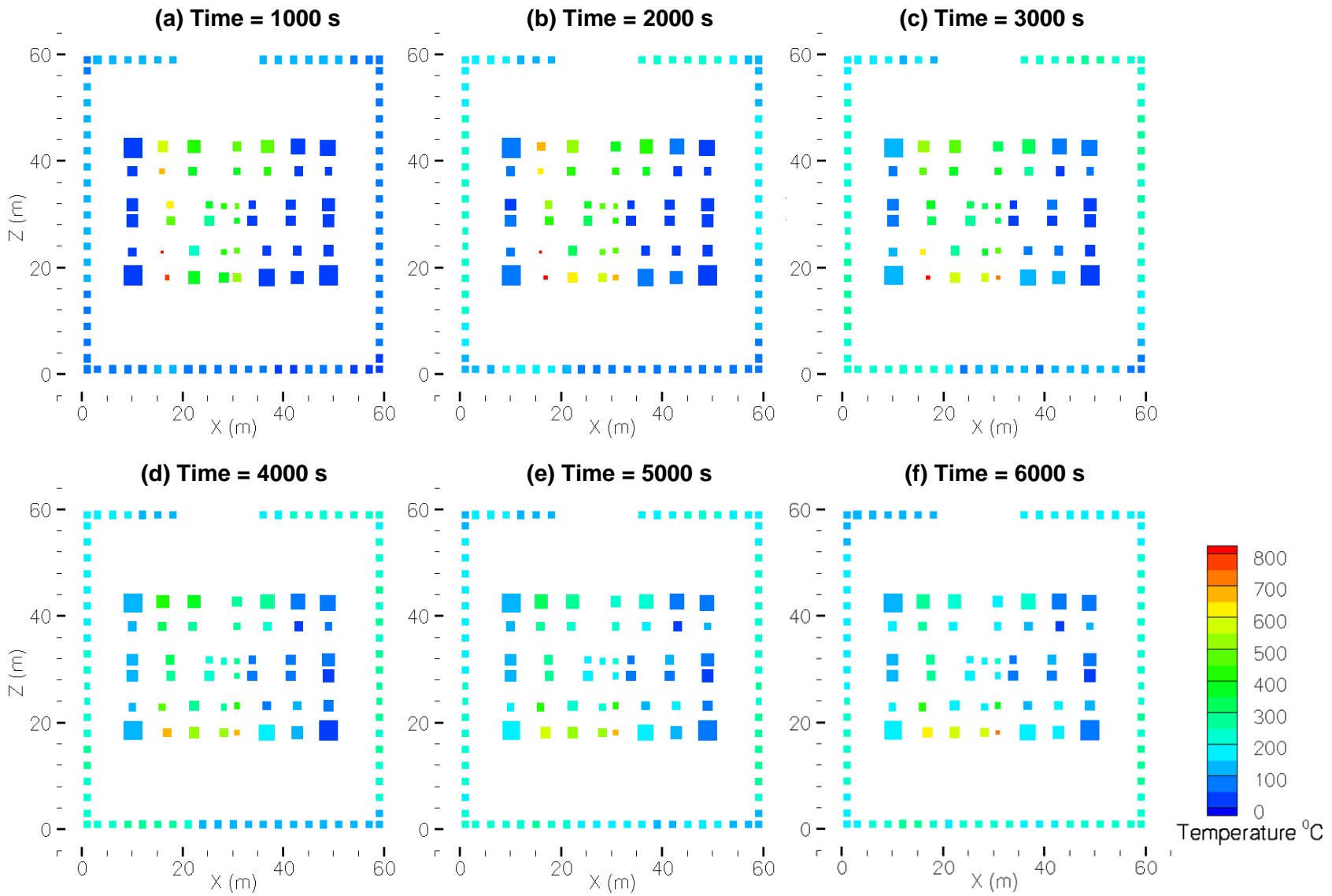

Figure 6-48. Frames from animation of the thermal response of columns on the 96<sup>th</sup> floor of WTC 1, Case A.

### 6.12.6 Characterization of the Thermal Profiles

Tables 6–8 and 6–9 summarize the regions of the floors in which the structural steel reached temperatures at which their yield strengths would have been significantly diminished. Instances of brief heating of one or two columns early in the fires were not included.

Even in the vicinity of the fires, the columns and trusses for which the insulation was intact did not heat to temperatures where significant loss of strength occurred.

Unlike the simulations of the aircraft impact and the fires, there was no evidence, photographic or other, for direct comparison with the FSI results.

**Table 6–8. Regions in WTC 1 in which temperatures of structural steel exceeded 600 °C.**

Floor Number	Trusses		Perimeter Columns		Core Columns	
	Case A	Case B	Case A	Case B	Case A	Case B
93	–	–	–	–	–	–
94	–	–	–	–	N, S	NE, S
95	N	N, S	–	–	S	NW, S
96	N	N, S	–	S	S	W, S
97	N, S	N, S	–	S	N	W, S
98	N	N, S	–	–	–	–
99	–	–	–	–	–	–

Key: N, north; NE, northeast; NW, northwest; S, south; W, west.

**Table 6–9. Regions in WTC 2 in which temperatures of structural steel exceeded 600 °C.**

Floor Number	Trusses		Perimeter Columns		Core Columns	
	Case C	Case D	Case C	Case D	Case C	Case D
79	–	–	–	–	–	–
80	–	–	–	–	–	–
81	NE	NE	NE	NE	–	NE
82	E	E	E	E	E	E
83	E	E	–	E	–	E

Key: E, east; NE, northeast.

## 6.13 MEASUREMENT OF THE FIRE RESISTANCE OF THE FLOOR SYSTEM

As described in Section 5.4.7, the composite floor system, composed of open-web, lightweight steel trusses topped with a slab of lightweight concrete, was an innovative feature. As further noted in Section 5.6.2, the approach to achieving the specified fire resistance for these floors was the use of a SFRM. Documents indicated that the fire performance of the composite floor system of the WTC towers was an issue of concern to the building owners and designers. However, NIST found no evidence regarding the technical basis for the selection of insulation material for the floor trusses or for the insulation thickness to achieve a 2 hour rating. Further, NIST has found no evidence that fire resistance tests of the WTC floor system were conducted.

Most of the possible building collapse sequences included some contribution from the floors, ranging from their ability to transfer load to their initiating the collapse by their failure. Thus, it became central to the Investigation to obtain data regarding the limits of the insulated floors in withstanding the heat from the fires. The standard test for determining the fire endurance of floor assemblies is ASTM E 119, “Standard Test Methods for Fire Tests of Building Construction and Materials.” The conduct of the test is described in Section 1.2.2 under “Fire Protection Systems.”

Accordingly, NIST contracted with Underwriters Laboratories, Inc. to conduct tests to obtain information on the fire endurance of trusses like those in the WTC towers. The objective was to understand the effects of three factors:

- **Scale of the test.** There were no established facilities capable of testing the 60 ft lengths of the long spans that were used in the towers, but there is a history of testing reduced-scale assemblies and scaling them to practical dimensions. In the Investigation’s tests, the full-scale test specimens were 35 ft long, equal to the shorter span between the core and the perimeter of the WTC towers. Their construction replicated, as closely as possible, the original short-span floors. The reduced-scale specimens were half that length and height. All assemblies were 14 ft wide. The simulation of a “maximum load condition,” as required by ASTM E 119, involved placing a combination of concrete blocks and containers filled with water on the top surface of the floor. The load on the shorter truss was double that of the longer truss to achieve the same state of stress in both trusses. Traditionally, relatively small-scale assemblies have been tested and results have been scaled to practical floor system spans.
- **SFRM thickness.** The Port Authority originally specified BLAZE-SHIELD D as the SFRM, applied to a ½ in. covering. The average measured thicknesses were found to be approximately 0.75 in. These two thicknesses of BLAZE-SHIELD D were used in the Investigation tests.
- **Test restraint conditions.** In 1971, well after the design of the towers was completed, the ASTM E 119 Standard began differentiating between thermally restrained and unrestrained floor assemblies. An unrestrained assembly is free to expand thermally and to rotate at its supports; a restrained assembly is not. It is customary in the United States to conduct standard fire tests of floor assemblies in the restrained condition. The current standard describes a means to establish unrestrained ratings for floor assemblies from restrained test results. In practice, a floor assembly such as that used in the WTC towers is neither restrained nor unrestrained but is likely somewhere in between. Testing under both restraint conditions, then, is thought to bound performance under the standard fire exposure. In addition, it provided a comparison of unrestrained ratings developed from both restrained and unrestrained test conditions.

The test plan included four tests, which varied the three factors:

Test 1: 35 ft floor, ¾ in. insulation, restrained

Test 2: 35 ft floor, ¾ in. insulation, unrestrained



Test 3: 17 ft floor, ¾ in. insulation, restrained

Test 4: 17 ft floor, ½ in. insulation, restrained

The results of the four tests are summarized as follows:

- All four test assemblies were able to withstand standard fire conditions for between ¾ hour and 2 hours without exceeding the limits prescribed by ASTM E 119.
- All four test specimens sustained the maximum design load for approximately 2 hours without collapsing.
- The restrained full-scale floor system obtained a fire resistance rating of 1½ hours, while the unrestrained floor system achieved a 2 hour rating. Past experience with the ASTM E 119 test method led investigators to expect the unrestrained floor assembly to receive a lower rating than the restrained assembly.
- For assemblies with a ¾ in. SFRM thickness, the 17 ft assembly's fire rating was 2 hours; the 35 ft assembly's rating was 1½ hours. This result raised the question of whether or not a fire rating of a 17 ft floor assembly is scalable to the longer spans in the WTC towers.
- The specimen in Test 4, with a fire rating of ¾ hour, would not have met the 2 hour requirement of the NYC Building Code.

The Investigation Team was cautious about using these results directly in the formulation of collapse hypotheses. In addition to the scaling issues raised by the test results, the fires in the towers on September 11, and the resulting exposure of the floor systems, were substantially different from the conditions in the test furnaces. Nonetheless, the results established that this type of assembly was capable of sustaining a large gravity load, without collapsing, for a substantial period of time relative to the duration of the fires in any given location on September 11.

## **6.14 COLLAPSE ANALYSIS OF THE TOWERS**

### **6.14.1 Approach to Determining the Probable Collapse Sequences**

At the core of NIST's reconstruction of the events of September 11, 2001, were the archive of photographic and video evidence, the observations of people who were on the scene, the assembled documents describing the towers and the aircraft, and Investigation-generated experimental data on the properties of construction and furnishing materials and the behavior of the fires. Information from all of these sources fed the computer simulations of the towers, the aircraft impacts, the ensuing fires and their heating of the structural elements, and the structural changes that led to the collapse of the towers. To the extent that the input information was complete and accurate, the output of the simulations would have provided definitive responses to the first three objectives of the Investigation. However, the available information, as extensive as it was, was neither complete nor of assured precision. As a result, the Investigation Team took steps to ensure that the conclusions of the effort were credible explanations for how the buildings collapsed and the extent to which the casualties occurred.

One principal step was the determination of those variables that most affected the outcome of the various computer simulations. Sensitivity studies and examination of components and subsystems were carried out for the modeling of the aircraft impact, the fires, and the structural response to impact damage and fires. For each of the most influential variables, a central or middle value and reasonable high and low values were identified. Further computations refined the selection of these values. The computations also were improved to include physical processes that could play a significant role in the structural degradation of the towers.

The Investigation Team then defined three cases for each building by combining the middle, less severe, and more severe values of the influential variables. Upon a preliminary examination of the middle cases, it became clear that the towers would likely remain standing. The less severe cases were discarded after the aircraft impact results were compared to observed events. The middle cases (which became Case A for WTC 1 and Case C for WTC 2) were discarded after the structural response analysis of major subsystems were compared to observed events. The more severe case (which became Case B for WTC 1 and Case D for WTC 2) was used for the global analysis of each tower.

Complete sets of simulations were then performed for Cases B and D. To the extent that the simulations deviated from the photographic evidence or eyewitness reports, the investigators adjusted the input, but only within the range of physical reality. Thus, for instance, the observed window breakage was an input to the fire simulations and the pulling forces on the perimeter columns by the sagging floors were adjusted within the range of values derived from the subsystem computations.

The results were a simulation of the structural deterioration of each tower from the time of aircraft impact to the time at which the building became unstable, i.e., was poised for collapse. Cases B and D accomplished this in a manner that was consistent with the principal observables and the governing physics.

#### **6.14.2 Results of Global Analysis of WTC 1**

After the aircraft impact, gravity loads that were previously carried by severed columns were redistributed to other columns. The north wall lost about 7 percent of its loads after impact. Most of the load was transferred by the hat truss, and the rest was redistributed to the adjacent exterior walls by spandrels. Due to the impact damage and the tilting of the building to the north after impact, the south wall also lost gravity load, and about 7 percent was transferred by the hat truss. As a result, the east and west walls and the core gained the redistributed loads through the hat truss.

Structural steel and concrete expand when heated. In the early stages of the fire, temperatures of structural members in the core rose, and the resulting thermal expansion of the core columns was greater than the thermal expansion of the (cooler) exterior walls. The floors also thermally expanded in the early stages of the fires. About 20 min after the aircraft impact, the difference in the thermal expansion between the core and exterior walls, which was resisted by the hat truss, caused the core columns' loads to increase. As floor temperatures increased, the floors sagged and began to pull inward on the exterior wall. As the fires continued to heat areas of the core that were without insulation, the columns weakened and shortened and began to transfer their loads to the exterior walls through the hat truss until the south wall started to bow inward due to the inward pull of the sagging floors. At about 100 min, approximately 20 percent of the core loads had been transferred by the hat truss to the exterior walls due to weakening of

the core, the loads on the north and south walls had each increased by about 10 percent, and those on the east and west walls had about a 25 percent increase. The increased loads on the east and west walls were due to their relatively higher stiffness compared to the impact damaged north wall and bowed south walls.

The inward bowing of the south wall caused failure of exterior column splices and spandrels, and these columns became unstable. The instability spread horizontally across the entire south face. The south wall, now unable to bear its gravity loads, redistributed these loads to the thermally weakened core through the hat truss and to the east and west walls through the spandrels. The building section above the impact zone began tilting to the south as the columns on the east and west walls rapidly became unable to carry the increased loads. This further increased the gravity loads on the core columns. The gravity loads could no longer be redistributed, nor could the remaining core and perimeter columns support the gravity loads from the floors above. Once the upper building section began to move downwards, the weakened structure in the impact and fire zone was not able to absorb the tremendous energy of the falling building section and global collapse ensued.

### 6.14.3 Results of Global Analysis of WTC 2

Before aircraft impact, the load distribution across the exterior walls and core was symmetric with respect to the centerline of each exterior wall. After aircraft impact, the exterior column loads on the south side of the east and west walls and on the east side of south wall increased. This was due to the leaning of the building core towards the southeast. After aircraft impact, the core carried 6 percent less load. The north wall load reduced by 6 percent and the east face load increased by 24 percent. The south and west walls carried 2 percent to 3 percent more load.

In contrast to the fires in WTC 1, which generally progressed from the north side of the building to the south side over approximately 1 hour, the fires in WTC 2 were located on the east side of the core and floors from the time of impact until the building collapsed, with the fires spreading somewhat from south to north. With insulation dislodged over much of the same area, the structural temperatures became elevated in the core, floors, and exterior walls at similar times. During the early stages of the fires, columns with dislodged insulation elongated due to thermal expansion. As the structural temperatures continued to rise, the columns thermally weakened and consequently shortened. Thermal expansion of the floors also occurred early in the fires, but as floor temperatures increased, the floors sagged and began to pull inward on the exterior columns.

The south exterior wall displaced downward following the aircraft impact, but did not displace further until the east wall became unstable 43 min later. The inward bowing of the east wall, due to the inward pull of the sagging floors, caused failure of exterior column splices and spandrels and resulted in the east wall columns becoming unstable. The instability progressed horizontally across the entire east face. The east wall, now unable to bear its gravity loads, redistributed them to the thermally weakened core through the hat truss and to the east and west walls through the spandrels.

The building section above the impact zone began tilting to the east and south as column instability progressed rapidly from the east wall along the adjacent north and south walls, and increased the gravity load on the weakened east core columns. The gravity loads could no longer be redistributed, nor could the remaining core and perimeter columns support the gravity loads from the floors above. As with WTC 1, once the upper building section began to move downwards, the weakened structure in the impact

and fire zone was not able to absorb the tremendous energy of the falling building section and global collapse ensued.

#### **6.14.4 Events Following Collapse Initiation**

Failure of the south wall in WTC 1 and east wall in WTC 2 caused the portion of the building above to tilt in the direction of the failed wall. The tilting was accompanied by a downward movement. The story immediately below the stories in which the columns failed was not able to arrest this initial movement as evidenced by videos from several vantage points.

The structure below the level of collapse initiation offered minimal resistance to the falling building mass at and above the impact zone. The potential energy released by the downward movement of the large building mass far exceeded the capacity of the intact structure below to absorb that through energy of deformation.

Since the stories below the level of collapse initiation provided little resistance to the tremendous energy released by the falling building mass, the building section above came down essentially in free fall, as seen in videos. As the stories below sequentially failed, the falling mass increased, further increasing the demand on the floors below, which were unable to arrest the moving mass.

The falling mass of the building compressed the air ahead of it, much like the action of a piston, forcing material, such as smoke and debris, out the windows as seen in several videos.

NIST found no corroborating evidence for alternative hypotheses suggesting that the WTC towers were brought down by controlled demolition using explosives planted prior to September 11, 2001. NIST also did not find any evidence that missiles were fired at or hit the towers. Instead, photographs and videos from several angles clearly show that the collapse initiated at the fire and impact floors and that the collapse progressed from the initiating floors downward, until the dust clouds obscured the view.

#### **6.14.5 Structural Response of the WTC Towers to Fire without Impact or Thermal Insulation Damage**

To complete the assessment of the relative roles of aircraft impact and ensuing fires, NIST examined whether an intense, but conventional, fire, occurring without the aircraft impact, could have led to the collapse of a WTC tower, were the tower in the same condition as it was on September 10, 2001. NIST used the observations, information, and analyses developed during the Investigation to enable the formulation of probable limits to the damage from such a fire. Since a complete analysis beyond the actual collapse times of the towers was not conducted, the findings in this section represent NIST's best technical judgment based on the available observations, information, and analyses:

- Ignition on a single floor by a small bomb or other explosion. If arson were involved, there might have been multiple small fires ignited on a few floors.
- Air supply determined by the building ventilation system.
- Moderate fire growth rate. In the case of arson, several gallons of an accelerant might have been applied to the building combustibles, igniting the equivalent of several workstations.

- Water supply to the sprinklers and standpipes maliciously compromised.
- Intact structural insulation and interior walls.

The four cases described in this chapter represented fires that were far more severe than this:

- About 10,000 gallons of jet fuel were sprayed into multiple stories, quickly and simultaneously igniting hundreds of workstations and other combustibles.
- The aircraft and subsequent fireballs created large open areas in the building exterior through which air could flow to support the fires.
- The impact and debris removed the insulation from a large number of structural elements that were then subjected to the heat from the fires.

Additional findings from the Investigation showed that:

- Both the results of the multiple workstation experiments and the simulations of the WTC fires showed that the combustibles in a given location, if undisturbed by the aircraft impact, would have been almost fully burned out in about 20 min.
- In the simulations of Cases A through D, none of the columns and trusses for which thermal insulation was intact reached temperatures at which significant loss of strength occurred. Thermal analyses showed that steel temperatures in areas where the insulation remained intact rarely exceeded 400 °C in WTC 1 and 500 °C in WTC 2.
- In WTC 1, if fires had been allowed to continue past the time of building collapse, complete burnout would likely have occurred within a short time since the fires had already traversed around the entire floor and most of the combustibles would already have been consumed (see Figure 6–38). During the extended period from collapse to burnout, the steel temperatures would likely not have increased very much. The installed insulation in the fire-affected floors of this building had been upgraded to an average thickness of 2.5 in.
- In a fire simulation of WTC 2, that was extended for 2 hours beyond Case D and with all windows broken during this period, the temperatures in the truss steel on the west side of the building (where the insulation was undamaged) increased for about 40 min before falling off rapidly as the combustibles were consumed. Results for a typical floor (floor 81) showed that temperatures of 700 °C to 760 °C were reached over approximately 15 percent of the west floor area for less than 10 min. Approximately 60 percent of the floor steel had temperatures between 600 °C and 700 °C for about 15 min. Approximately 70 percent of the floor steel had temperatures that exceeded 500 °C for about 45 min. At these temperatures, the floors would be expected to sag and then recover a portion of the sag as the steel began to cool. Based on results for Cases C and D, the temperatures of the insulated exterior and core columns would not have increased to the point where significant loss of strength or stiffness would occur during these additional 2 hours. With intact, cool core columns, any inward bowing of the west exterior wall that might occur would be readily supported by the adjacent exterior walls and core columns.

- Both WTC 1 and WTC 2 were stable after the aircraft impact, standing for 102 min and 56 min, respectively. The global analyses with structural impact damage showed that both towers had considerable reserve capacity. This was confirmed by analysis of the post-impact vibration of WTC 2, the more severely damaged building, where the damaged tower oscillated with a peak amplitude that was between 30 percent and 40 percent of the sway under hurricane force winds for which the towers were designed and at periods nearly equal to the first two translation and torsion mode periods calculated for the undamaged structure.
- Computer simulations, supported by the results of large-scale fire tests and furnace testing of floor subsystems, showed that insulated structural steel, when coated with the average installed insulation thickness of  $\frac{3}{4}$  in., would not have reached high temperatures (i.e., greater than 650 °C) from nearby fires for a longer time than the burnout time of the combustibles (approximately 20 min for 4 lb/ft<sup>2</sup> of combusted material). Simulations also showed that variations in thickness resulting from normal application, even with occasional gaps in coverage, would not have changed this result.
- Inward bowing of the exterior walls in both WTC 1 and WTC 2 was observed only on the face with the long-span floor system. In WTC 1, this was found to be the case even though equally extensive fires were observed on all faces. In WTC 2, fires were not observed on the long-span west face and were less intense on the short-span faces than on the east face.
- Inward bowing was a necessary but not sufficient condition to initiate collapse. In both WTC 1 and WTC 2, significant weakening of the core due to aircraft impact damage and thermal effects was also necessary to initiate building collapse.
- The tower structures had significant capacity to redistribute loads (a) from bowed walls to adjacent exterior walls with short-span floors via the arch action of spandrels, and (b) between the core and exterior walls via the hat truss and, to a lesser extent, the floors.

In evaluating how the undamaged towers would have performed in an intense, conventional fire, NIST considered the following factors individually and in combination:

- The *temperatures* that would be reached in structural steel components with intact insulation.
- The *extent of the area* over which high temperatures (e.g., greater than 600 °C where significant thermal weakening of the steel occurs) would be reached at any given time.
- The *duration* over which the high temperatures would be sustained concurrently in any given area.
- The *length of the floor span* (long or short) where high temperatures would be reached.
- The *number of floors* with areas where high temperatures would be sustained concurrently in the long-span direction.

- The *potential for inward bowing of exterior walls* (i.e., magnitude and extent of bowing over the width of the face and the number of floors involved) due to thermally induced floor sagging of long-span floors and associated inward pull forces.
- The *capacity of the structure to redistribute loads* (e.g., via the spandrels, hat truss, and floors) if the thermal conditions were sufficiently intense to cause inward bowing of the exterior walls.

In addition, NIST considered the following known facts:

- WTC 1 did not collapse during the major fire in 1975, which engulfed a large area (about one-fourth of the floor area or 9,000 ft<sup>2</sup>) on the southeast quadrant of the 11th floor. At the time, office spaces in the towers were not sprinklered. The fire caused minimal damage to the floor system with the ½ in. specified insulation thickness applied on the trusses (four trusses were slightly distorted), and at no time was the load-carrying capacity compromised for the floor system or the structure as a whole.
- Four standard fire resistance tests of floor assemblies like those in the WTC towers conducted as part of this Investigation showed that (a) it took about 90 min of sustained heating in the furnace for temperatures to exceed 600 °C on steel truss members with either ½ in. or ¾ in. insulation thickness, and (b) in no case was the load-carrying capacity compromised by heating of the floor system for 2 hours at furnace temperatures, with applied loads exceeding those on September 11 by a factor of two.

From these findings, factors, and observed performance, NIST concluded:

- In the absence of structural and insulation damage, a conventional fire substantially similar to or less intense than the fires encountered on September 11, 2001, likely would not have led to the collapse of a WTC tower.
- The condition of the insulation prior to aircraft impact, which was found to be mostly intact, and the insulation thickness on the WTC floor system contributed to, but did not play a governing role, in initiating collapse of the towers.
- The towers likely would not have collapsed under the combined effects of aircraft impact and the subsequent multi-floor fires encountered on September 11 if the thermal insulation had not been widely dislodged or had been only minimally dislodged by aircraft impact.

These findings apply to fires that are substantially similar to or less intense than those encountered on September 11, 2001. They do not apply to a standard fire or an assumed fire exposure which has (a) uniform high temperatures over an entire floor or most of a floor (note that the WTC floors were extremely large) and concurrently over multiple floors, (b) high temperatures that are sustained indefinitely or for long periods of time (greater than about 20 min at any location), and (c) combusted fire loads that are significantly greater than those considered in the analyses. They also do not apply if the capacity of the undamaged structure to redistribute loads via the spandrels, hat truss, and floors is not accounted for adequately in a full 3-dimensional simulation model of the structure.

### 6.14.6 Probable WTC 1 Collapse Sequence

#### Aircraft Impact Damage

- The aircraft impact severed a number of exterior columns on the north wall from the 93<sup>rd</sup> to the 98<sup>th</sup> floors, and the wall section above the impact zone moved downward.
- After breaching the building's perimeter, the aircraft continued to penetrate into the building, severing floor framing and core columns at the north side of the core. Core columns were also damaged toward the center of the core. Insulation was damaged from the impact area to the south perimeter wall, primarily through the middle one-third to one-half of the core width. Finally, the aircraft debris removed a single exterior panel at the center of the south wall between the 94<sup>th</sup> and 96<sup>th</sup> floors.
- The impact damage to the exterior walls and to the core resulted in redistribution of severed column loads, mostly to the columns adjacent to the impact zones. The hat truss resisted the downward movement of the north wall.
- Loads on the damaged core columns were redistributed mostly to adjacent intact core columns and to a lesser extent to the north perimeter columns through the core floor systems and the hat truss.
- As a result of the aircraft impact damage, the north and south walls each carried about 7 percent less gravity load after impact, and the east and west walls each carried about 7 percent more load. The core carried about 1 percent more gravity load after impact.

#### Thermal Weakening of the Structure

- Under the high temperatures and stresses in the core area, the remaining core columns with damaged insulation were thermally weakened and shortened, causing the columns on the floors above to move downward. The hat truss resisted the core column shortening and redistributed loads to the perimeter walls. The north and south walls' loads increased by about 10 percent, and the east and west walls' loads increased by about 25 percent, while the core's loads decreased by about 20 percent.
- The long-span sections of the 95<sup>th</sup> to 99<sup>th</sup> floors on the south side weakened with increasing temperatures and began to sag. Early on, the floors on the north side had sagged and then contracted as the fires moved to the south and the floors cooled. As the fires intensified on the south side, the floors there sagged, and the floor connections weakened. About 20 percent of the connections on the south side of the 97<sup>th</sup> and 98<sup>th</sup> floors failed.
- The sagging floors with intact floor connections pulled inward on the south perimeter columns, causing them to bow inward.



## Collapse Initiation

- The bowed south wall columns buckled and were unable to carry the gravity loads. Those loads shifted to the adjacent columns via the spandrels, but those columns quickly became overloaded as well. In rapid sequence, this instability spread all the way to the east and west walls.
- The section of the building above the impact zone (near the 98<sup>th</sup> floor), acting as a rigid block, tilted at least 8 degrees to the south.
- The downward movement of this structural block was more than the damaged structure could resist, and global collapse began.

### 6.14.7 Probable WTC 2 Collapse Sequence

#### Aircraft Impact Damage

- The aircraft impact severed a number of exterior columns on the south wall from the 78<sup>th</sup> floor to the 84<sup>th</sup> floor, and the wall section above the impact zone moved downward.
- After breaching the building's perimeter, the aircraft continued to penetrate into the building, severing floor framing and core columns at the southeast corner of the core. Insulation was damaged from the impact area through the east half of the core to the north and east perimeter walls. The floor truss seat connections over about one-fourth to one-half of the east side of the core were severed on the 80<sup>th</sup> and 81<sup>st</sup> floors and over about one-third of the east perimeter wall on the 83<sup>rd</sup> floor. The debris severed four columns near the east corner of the north wall between the 80<sup>th</sup> and 82<sup>nd</sup> floors.
- The impact damage to the perimeter walls and to the core resulted in redistribution of severed column loads, mostly to the columns adjacent to the impact zones. The impact damage to the core columns resulted in redistribution of severed column loads, mainly to other intact core columns and the east exterior wall. The hat truss resisted the downward movement of the south wall.
- As a result of the aircraft impact damage, the core carried about 6 percent less gravity load. The north wall carried about 10 percent less, the east face carried about 24 percent more, and the west and south faces carried about 3 percent and two percent more, respectively.
- The core was then leaning slightly toward the south and east perimeter walls. The perimeter walls restrained the tendency of the core to lean via the hat truss and the intact floors.

#### Thermal Weakening of the Structure

- Under the high temperatures and stresses in the core area, the remaining core columns with damaged insulation were thermally weakened and shortened, causing the columns on the floors above to move downward.

- At this point, the east wall carried about 5 percent more of the gravity loads, and the core carried about 2 percent less. The other three walls carried between 0 percent and 3 percent less.
- The long-span floors on the east side of the 79<sup>th</sup> to 83<sup>rd</sup> floors weakened with increasing temperatures and began to sag. About one-third of the remaining floor connections to the east perimeter wall on the 83<sup>rd</sup> floor failed.
- Those sagging floors whose seats were still intact pulled inward on the east perimeter columns, causing them to bow inward. The inward bowing increased with time.

### **Collapse Initiation**

- As in WTC 1, the bowed columns buckled and became unable to carry the gravity loads. Those loads shifted to the adjacent columns via the spandrels, but those columns quickly became overloaded. In rapid sequence, this instability spread all across the east wall.
- Loads were transferred from the failing east wall to the weakened core through the hat truss and to the north and south walls through the spandrels. The instability of the east face spread rapidly along the north and south walls.
- The building section above the impact zone (near the 82<sup>nd</sup> floor) tilted 7 degrees to 8 degrees to the east and 3 degrees to 4 degrees to the south prior to significant downward movement of the upper building section. The tilt to the south did not increase any further as the upper building section began to fall, but the tilt to the east was seen to increase to 20 degrees until dust clouds obscured the view.
- The downward movement of this structural block was more than the damaged structure could resist, and the global collapse began.

#### **6.14.8 Accuracy of the Probable Collapse Sequences**

Independent assessment of the validity of the key steps in the collapse of the towers was a challenging task. Some of the photographic information had been used to direct the simulations. For example, the timing of the appearance of broken windows was an input to the fire growth modeling. However, there were significant observables that were usable as corroborating evidence, as shown in Tables 6–10 and 6–11. Some of these were used to establish the quality of the individual simulations of the aircraft impact and the fire growth, as described in Sections 6.9 and 6.10. While the agreement between observations and simulation was not exact, the differences were within the uncertainties in the input information. The generally successful comparisons lent credibility to the overall reconstruction of the disaster.

There remained a small, but important number of observations against which the structural collapse sequences could be judged. The comparisons are for Cases B and D impact damage and temperature histories, for which the better agreement was obtained.

**Table 6–10. Comparison of global structural model predictions and observations for WTC 1, Case B.**

Observation	Simulation
Following the aircraft impact, the tower still stood.	The tower remained upright with significant reserve capacity.
The south perimeter wall was first observed to have bowed inward at 10:23 a.m. The bowing appeared over nearly the entire south face of the 94 <sup>th</sup> to 100 <sup>th</sup> floors. The maximum bowing was 55 in. on the 97 <sup>th</sup> floor. (The central area in available images was obscured by smoke.)	The inward bowing of the south wall at 10:28 a.m. It extended from the 94 <sup>th</sup> to the 100 <sup>th</sup> floor, with a maximum of about 43 in.
As the structural collapse began, the building section above the impact and fire zone tilted at least 8 degrees to the south with no discernable east or west component in the tilt. Dust clouds obscured the view as the building section began to fall downward.	The south side bowed and weakened. The analysis stopped as the initiation of global instability was imminent.
The time to collapse initiation was 102 min from the aircraft impact.	There was significant weakening of the south wall and the core columns. Instability was imminent at 100 min.

**Table 6–11. Comparison of global structural model predictions and observations for WTC 2, Case D.**

Observation	Simulation
Following the aircraft impact, the tower still stood.	The tower remained upright with significant reserve capacity.
The east perimeter wall was first observed to have bowed inward approximately 10 in. at floor 80 at 9:21 a.m. The bowing extended across most of the east face between the 78 <sup>th</sup> and 83 <sup>rd</sup> floors.	The inward bowing of the east wall had a maximum value of about 9.5 in. at 9:23 a.m. The bowing extended from the 78 <sup>th</sup> floor to the 83 <sup>rd</sup> floor.
The building section above the impact and fire area tilted to the east and south as the structural collapse initiated. The angle was approximately 3 degrees to 4 degrees to the south and 7 degrees to 8 degrees to the east prior to significant downward movement of the upper building section. The tilt to the south did not increase as the upper building section began to fall, but the tilt to the east rose to approximately 25 degrees before dust clouds obscured the view.	At point of instability, there was tilting to the south and east.
The time to collapse initiation was 56 min after the aircraft impact.	The analysis predicted global instability after 43 min.

The agreement between the observations and the simulations is reasonably good, supporting the validity of the probable collapse sequences. The exact times to collapse initiation were sensitive to the factors that controlled the inward bowing of the exterior columns. The sequence of events leading to collapse initiation was not sensitive to these factors.

#### **6.14.9 Factors that Affected Building Performance on September 11, 2001**

- The unusually dense spacing of perimeter columns, coupled with deep spandrels, resulted in a robust building that was able to fragment the aircraft upon impact and redistribute loads from severed perimeter columns to adjacent, intact columns.
- The wind loads used for the WTC towers, which governed the design of the framed-tube system, significantly exceeded the requirements of the building codes of the era and were consistent with the independent NIST estimates that were based on current state-of-the-art considerations.
- The robustness of the perimeter framed-tube system and the large lateral dimension of the towers helped the buildings withstand the impact of the aircraft.
- The composite floor system enabled the floors to redistribute loads from places of aircraft impact damage to other locations, avoiding larger scale collapse upon impact.
- The hat truss resisted the significant weakening of the core by redistributing loads from the damaged columns to intact columns.

As a result of these factors, the buildings would likely not have collapsed under the combined effects of the aircraft damage and subsequent fires if the insulation had not been widely dislodged. The thickness and the condition of the insulation prior to aircraft impact did not play a governing role in the initiation of building collapse.

## Chapter 7

# RECONSTRUCTION OF HUMAN ACTIVITY

---

### 7.1 BUILDING OCCUPANTS

#### 7.1.1 Background

While much attention has properly focused on the nearly three thousand people who lost their lives at the World Trade Center (WTC) site that day, the circumstances and efforts that led to the successful evacuation of five times that many people from the WTC towers also have been given attention. Understanding why the loss of life was high or low was one of the four objectives of the Investigation.

Success in clearing a building in an emergency can be characterized by two quantities: the time people need to evacuate and the time available to them to do so. For the WTC towers, the times available for escape were set by the collapse of the buildings. Neither the building occupants nor the emergency responders knew those times in advance. Moreover, the times were also three or four times shorter than the time needed to clear the tenant spaces of WTC 1 following the 1993 bombing.

The investigators examined the design of the buildings, the behavior of the people, and the evacuation process in detail to ascertain the factors that figured prominently in the time needed for evacuation. In analyzing these factors, NIST recognized that there were inherent uncertainties in constructing a valid portrayal of human behavior on that day. These included limitations in the recollections of the people, the need to derive findings from a statistical sampling of the building population, the lack of information from the decedents on the factors that prevented their escape, and the limited knowledge of the damage to the interior of the towers. NIST carefully considered these uncertainties in developing its findings and is confident in those findings and related recommendations.

#### 7.1.2 The Building Egress System

Examination of drawings, memoranda, and calculations showed that the standard emergency evacuation procedures required using the three stairwells. The elevators were not to be used, and the doors to the roof were to be kept locked. Under most circumstances, a local evacuation would be ordered. The people on the floors near the threat would move to three floors below the incident. Under more severe circumstances, a full building evacuation would be ordered, requiring all occupants to leave the building by way of the stairwells.

As noted in Section 1.2.2, the locations of the stairwells differed at various heights in the buildings. This, combined with the aircraft impacting different floors in the two towers, the different aircraft impact location relative to the center of the building, and the different orientation of the core (Section 1.2.2), led to different damage to the stairwells. As shown in Figure 7–1, a frame from a simulation from a NIST contractor, Applied Research Associates (Section 6.9), the stairwell separation in this region of WTC 1 was the smallest in the building—clustered together well within the building core—and American Airlines Flight 11 destroyed all three stairwells from the 92<sup>nd</sup> floor upward. By contrast, the separation of the stairwells in the impacted region of WTC 2 was the largest in the building, i.e., they were located

along different boundaries of the building core. United Airlines Flight 175 destroyed Stairwells B and C, but not Stairwell A (Figure 7-2).

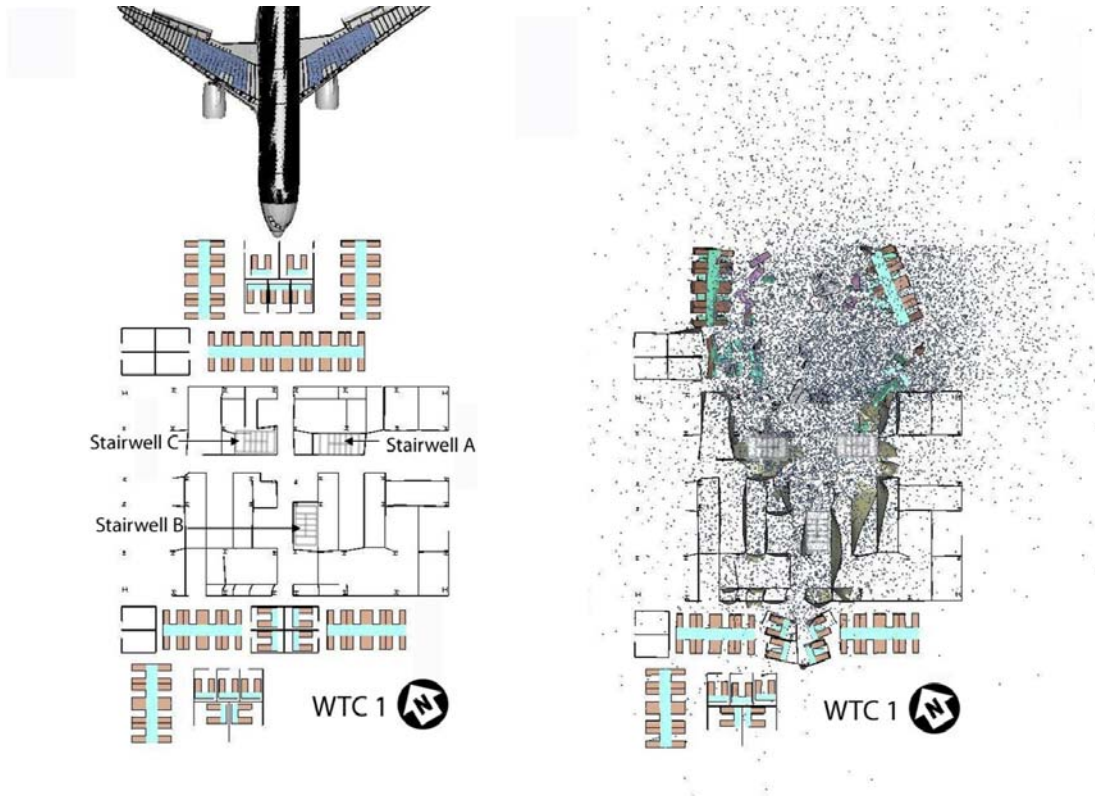

**Figure 7-1. Simulated impact damage to 95<sup>th</sup> floor of WTC 1, including stairwells, 0.7 s after impact.**

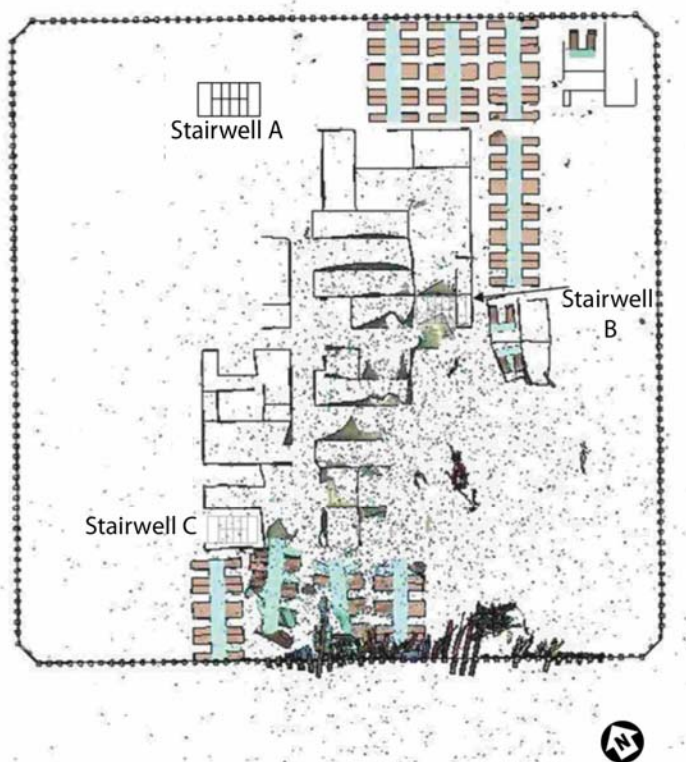

**Figure 7-2. Simulated impact damage to WTC 2 on floor 78, 0.62 s after impact.**

### 7.1.3 The Evacuation—Data Sources

To document the egress from the two towers as completely as possible, NIST:

- Contracted with the National Fire Protection Association and the National Research Council of Canada to index a collection of over 700 previously published interviews with WTC survivors.
- Listened to and analyzed 9-1-1 emergency phone calls made during the morning of September 11.
- Analyzed transcripts of emergency communication among building personnel and emergency responders.
- Examined complaints filed with the Occupational Safety and Health Administration by surviving occupants and families of victims regarding emergency preparedness and evacuation system performance.

In addition NIST, in conjunction with NuStats, Partners, LLP as a NIST contractor, conducted an extensive set of interviews with survivors of the disaster and family members of occupants of the buildings. First, telephone interviews were conducted with 803 survivors, randomly selected from the list of approximately 100,000 people who had badges to enter the towers on that morning. The results enabled a scientific projection of the population and distribution of occupants in WTC 1 and WTC 2, as well as exploration of factors that affected evacuation. Second, 225 face-to-face interviews, averaging 2 hours each, gathered detailed, first-hand accounts and observations of the activities and events inside the buildings on the morning of September 11. These people included occupants near the floors of impact, witnesses to fireballs, mobility-impaired occupants, floor wardens, building personnel with emergency response responsibilities, family members who spoke to an occupant after 8:46 a.m., and occupants from regions of the building not addressed by other groups. Third, six complementary focus groups, a total of 28 people, were convened, consisting of:

1. Occupants located near the floors of impact, to explore the extent of the building damage and how the damage influenced the evacuation process.
2. Floor wardens, to explore the implementation of the floor warden procedures and the effect those actions had on the evacuation of the occupants on a floor and the evacuation of the floor warden.
3. Mobility-impaired occupants, to explore the effect of a disability on the evacuation of the occupant and any other individuals who may have assisted or otherwise been affected by the evacuee.
4. Persons with building responsibilities, to capture the unique perspective of custodians, security, maintenance, or other building staff.

5. Randomly selected evacuees in WTC 1, to explore further the variables that best explained evacuation delay and normalized stairwell evacuation time, including environmental cues, floor, and activities.
6. Randomly selected evacuees in WTC 2, for the same purpose as the preceding group.

The following sections describe the key findings from this large data set.

#### **7.1.4 Occupant Demographics**

The following were estimated from statistical analysis of the telephone interview data:

- There were  $17,400 \pm 1,180$  occupants inside WTC 1 and WTC 2 at 8:46 a.m. Of these,  $8,900 \pm 750$  were inside WTC 1 and  $8,540 \pm 920$  were inside WTC 2.
- Men outnumbered women roughly two to one.
- The mean and median ages were both about 45, with the distribution ranging from the early 20s to the late 80s.
- The mean length of employment at the WTC was almost six years, but the median was only two years tenure within WTC 1 and three years within WTC 2.
- Sixteen percent of the evacuees were present during the 1993 bombing, although many others knew of the evacuation.
- Two-thirds had participated in at least one fire drill in the 12 months prior to the 2001 disaster. Eighteen percent did not recall whether they had participated or not; 18 percent reported that they had not. New York City law prohibited requiring full evacuation using the stairs during fire drills.
- Six percent reported having a limitation that constrained their ability to escape. (This extrapolated to roughly 1,000 of the WTC 1 and WTC 2 survivors.) The most common of these limitations, in decreasing order, were recent injury, chronic illness, and use of medications.

Estimates based on the layouts of the tenant spaces indicated that approximately 20,000 people worked in each tower. Relatively few visitors would have been present at 8:46 a.m. Thus, the towers were between one-third and one-half full at the time of the attack.

#### **7.1.5 Evacuation of WTC 1**

The number of survivors evacuated from WTC 1 was large, given the severity of the building damage and the unexpectedly short available time. Of those who were below the impact floors when the aircraft struck, 99 percent survived. About 84 percent of all the occupants of the tower at the time survived. The aircraft impact damage left no exit path for those who were above the 91<sup>st</sup> floor. It is not known how many of those could have been saved had the building not collapsed. While it is possible that a delayed



or avoided collapse could have improved the outcome, it would have taken many hours for the FDNY to reach the 92<sup>nd</sup> floor and higher and then to conduct rescue and fire suppression activity there.

The general pattern of the evacuation was described in Chapter 2. The following are specific facts derived from the interviews:

- The median time to initiate evacuation was 3 min for occupants from the ground floor to floor 76, and 5 min for occupants near the impact region (floors 77 through 91). The factors that best explained the evacuation initiation delays were the floor the respondent was on when WTC 1 was attacked, whether the occupant encountered smoke, damage or fire, and whether he or she sought additional information about what was happening.
- Occupants throughout the building observed various types of impact indicators throughout the building, including wall, partition, and ceiling damage and fire and smoke conditions. The filled-in squares in Figure 7–3 indicate the floors on which the different observations were reported.
- Damage to critical communications hardware likely prevented announcement transmission, and thus occupants did not hear announcements to evacuate, despite repeated attempts from the lobby fire command station.
- Evacuation rates reached a maximum in approximately 5 min, and remained roughly constant until the collapse of WTC 2, when the rate in WTC 1 slowed to about 20 percent of the maximum.
- The maximum downward travel rate was just over one floor per minute, slower than the slowest speed measured for non-emergency evacuations. This was in part because:
  - Occupants encountered smoke and/or damage during evacuation.
  - Occupants were often unprepared for the physical challenge of full building evacuation.
  - Occupants were not prepared to encounter transfer hallways during the descent.
  - Mobility-impaired occupants were not universally identified or prepared for full building evacuation.
  - Occupants interrupted their evacuation.
- The mobility-impaired occupants did not evacuate as evenly as the general population.
  - Those who were ambulatory generally walked down the stairs with one hand on each handrail, taking one step at a time. They were typically accompanied by another occupant or an emergency responder. Combined, they blocked others behind them from moving more rapidly.
  - On the 12<sup>th</sup> floor, FDNY personnel found 40 to 60 people, some of whom were mobility impaired. The emergency responders were assisting about 20 of these mobility-impaired

people down the stairs just prior to the collapse of the building. It is unknown how many of this group survived.

- Some mobility-impaired occupants requiring assistance to evacuate were left by coworkers, thereby imposing on strangers for assistance.

### 7.1.6 Evacuation of WTC 2

The evacuation from WTC 2 was markedly different from that from WTC 1. Over 90 percent of the occupants had started to self-evacuate before the second aircraft struck, and three-quarters of those from above the 78<sup>th</sup> floor had descended below the impact region prior to the second attack. (Nearly 3,000 occupants were able to survive due to self-evacuation and the use of the still-functioning elevators.) As a result, 91 percent of all the occupants survived. Eleven people from below the impact floors perished, about 0.1 percent. Eighteen people in or above the impact zone when the plane struck are known to have found the one passable stairway and escaped. It is not known how many others from the impact floors or above found their way to the passable stairway and did not make it out or how many could have been saved had the building not collapsed. A delayed or avoided collapse could have provided the additional time for more people to learn about and use the passable stairway.

The general pattern of the evacuation was described in Chapter 3. The following are specific facts derived from the interviews:

- The median time to initiate evacuation was 6 min, somewhat longer than in WTC 1.
- As in WTC 1, occupants observed various types of impact indicators throughout the building, including wall, partition, and ceiling damage and fire and smoke conditions (Figure 7–4).
- Building announcements were cited by many as a constraint to their evacuation, principally due to the 9:00 a.m. announcement instructing occupants to return to their work spaces. Crowdedness in the stairways, lack of instructions and information, as well as injured or disabled evacuees in the stairwells were the most frequently reported obstacles to evacuation.
- Evacuation rates from WTC 2 showed three distinct phases:
  - (1) Before WTC 2 was attacked, occupants used elevators, as well as stairs, to evacuate, resulting in approximately 40 percent of the eventual survivors leaving the building during that 16 min window.
  - (2) After WTC 2 was attacked and the elevators were no longer operational, the evacuation rate slowed down to a steady rate equivalent to the rate observed in WTC 1, which also had only stairs available to occupants.
  - (3) About 20 min prior to building collapse, the rate in WTC 2 slowed to approximately 20 percent of the stairwell-only evacuation rate.

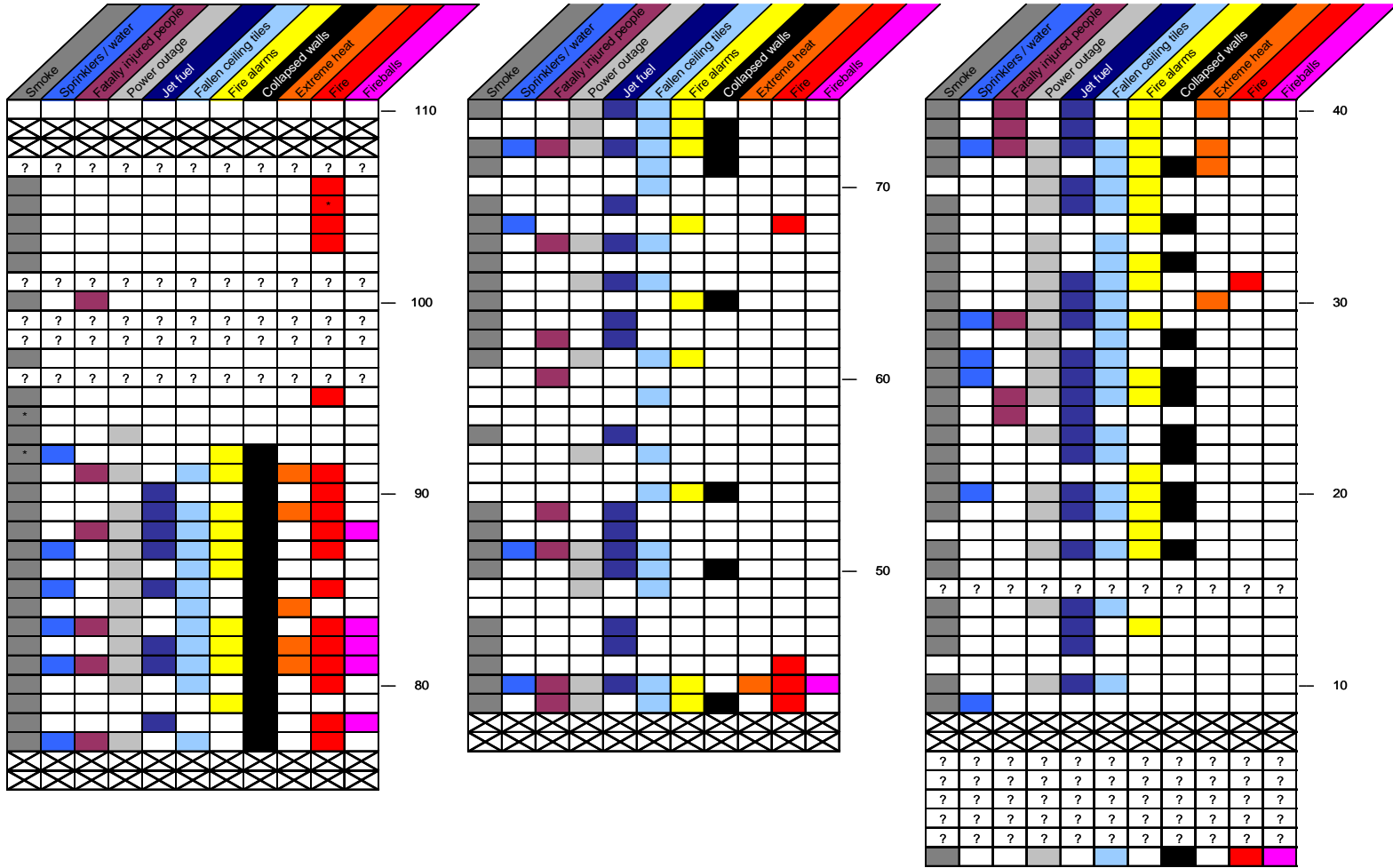

Figure 7-3. Observations of building damage after initial awareness but before beginning evacuation in WTC 1.

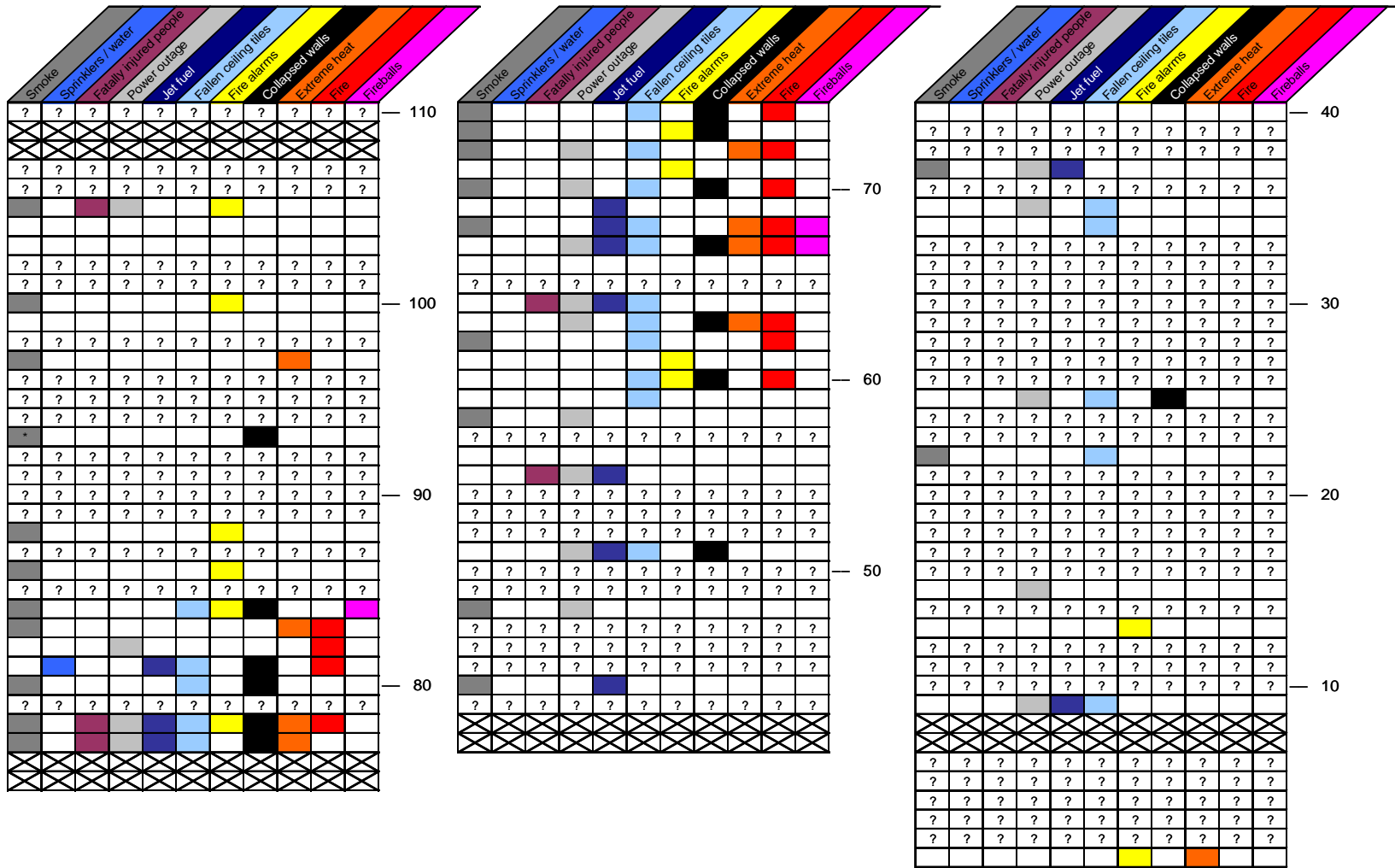

Figure 7-4. Observations of building damage from tenant spaces in WTC 2.

## **7.2 EMERGENCY RESPONDERS**

### **7.2.1 Data Gathered**

The attack on the World Trade Center produced a massive response from the emergency services within New York City. As a result, copious information was produced concerning the attack and the emergency response. Although some key information was lost when the buildings collapsed, an extensive amount was obtained from three organizations that contributed to the emergency response: The Port Authority of New York and New Jersey (Port Authority), FDNY, and the New York City Police Department (NYPD). There also was a significant amount of information available through the various media services. Some of the items were transferred to NIST; the Investigation Team examined others at locations in the New York City area. The data fell into four categories.

#### **Documentary Data**

This included procedures for conducting operations at the WTC, records generated during the WTC operations, and records generated following the event. The last group of documents included detailed investigative reports of the FDNY and NYPD operations by McKinsey and Company, documents of investigative first-person interviews, and lists of decedents.

#### **Electronic Data**

These were recordings of radio and telephone communications. Some were already in digital format; those on tape were digitized and/or transcribed. Some recordings required sound enhancement to improve comprehension.

#### **First-Person Interviews**

In October 2003, NIST entered into a three-party agreement between NIST, New York City (NYC), and the National Commission on Terrorist Acts Upon the United States (the 9/11 Commission). The agreement provided procedures under which NIST and the 9/11 Commission would interview a maximum of 125 NYC emergency responders, 100 from FDNY and 25 from NYPD. In December 2003, NIST officially requested and the Port Authority agreed to interviews with 15 Port Authority personnel, including emergency responders, safety, security, and management personnel. In addition to the interviews conducted under the agreements described above, NIST interviewed eight people who contacted NIST directly and volunteered. The first-person interviews were conducted beginning in October 2003 and were completed in December 2004.

The organizations and the number of interviews conducted were:

- FDNY (68 interviews): Senior management and officers, mid-level officers, company officers, firefighters, emergency medical personnel, and dispatchers
- NYPD (25 interviews): Senior management and officers, mid-level officers, Emergency Service Unit personnel, aviation personnel, and dispatchers

- PANYNJ/PAPD (15 interviews): Senior management personnel, facility safety personnel, building security personnel, facility communications personnel, building vertical transportation personnel, senior PAPD officers, mid-level PAPD officers, and line PAPD officers
- Other (8 interviews): A building security guard, dispatcher, firefighters, WTC building engineer, and a fire safety director

Each interview generally took from 1 hour to 4 hours to complete, depending on the person's job and the complexity of their involvement in emergency operations.

An interview included a self-narrative regarding the emergency responder's experience at the WTC and follow-up questions by staff from NIST and the 9/11 Commission.

### **Visual Data**

These still photographs and video footage became part of the collection described in Section 6.3.

### **7.2.2 Operation Changes following the WTC 1 Bombing on February 26, 1993**

This unprecedented act had provided insight into the complex nature of responding to a large incident at the WTC towers. As a result, numerous issues were raised concerning the WTC buildings in relationship to the emergency response. A multiagency study identified issues of security, occupant safety, and emergency responder operations and safety. The following changes made by The Port Authority and the FDNY had a direct impact on emergency responder operations on September 11, 2001.

#### **The Port Authority**

- Improved egress from the towers at the Concourse Level.
- Made improvements to the stairwells: battery operated emergency lighting, photoluminescent floor strips indicating the path to be followed, and explicit signs on each doorway to indicate where it led.
- Established a PAPD Command Center inside of WTC 5.
- Installed Fire Command Desks in the lobbies of WTC 1 and WTC 2.
- Installed in WTC 5 a radio repeater that operated on the FDNY city-wide high-rise frequency. (The radio repeater's function was to receive FDNY radio communication on a specified radio frequency, amplify the signal power, and retransmit the radio communications on another specified radio frequency that the FDNY radios could receive. This could enhance communications in buildings made of steel and reinforced concrete that pose challenges to radio-frequency communication.) The antenna was located on the top of WTC 5 and was directed at WTC 1 and WTC 2 (Figure 7-5). On September 11, 2001, the controls for operating the repeater were located at the Fire Command Desks in the tower lobbies.

- Upgraded the elevator intercom system to be monitored at the lobby Fire Command Desks.
- Constructed an Operations Control Center on the B1 level of WTC 2 with the capability to monitor all HVAC systems and elevators.
- Installed a decentralized fire alarm system, with three separate data risers to transponders located every three floors, redundant control panels and electronics, and multiple control station announcement capability.
- Conducted fire drills in conjunction with FDNY.

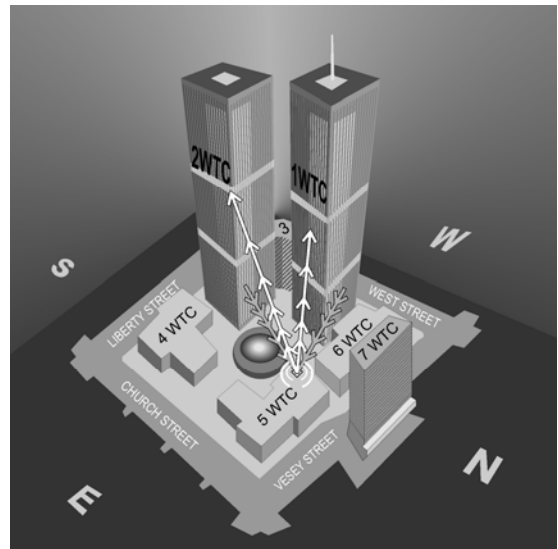

**Source:** Original artwork by Marco Crupi.  
Enhanced by NIST.

**Figure 7–5. Location of the radio repeater.**

## FDNY

- Published a new Incident Command System manual in May 1997.
- Purchased eighty 800 MHz radios for use by deputy fire commissioners, each staff chief, and the Field Communications Unit. Twenty of the radios were to be distributed by the Field Communications unit at an incident, if needed.
- Issued Port Authority radios to those FDNY companies located near the WTC that often responded to the WTC, allowing them to communicate with the building's Deputy Fire Safety Directors and with PAPD.

In addition, The Port Authority and New York City signed two agreements applying to the fire safety of Port Authority facilities located in New York City. The first agreement was for the implementation of fire safety recommendations that would be made by FDNY after they had inspected Port Authority facilities located in New York City. The second recognized the agreement that FDNY could conduct fire safety inspections of Port Authority properties in New York City. It provided guidelines for FDNY to communicate needed corrective actions to The Port Authority, and it assured that new or modified fire safety systems were to be in compliance with local codes and regulations. It also required a third party review of the systems by a New York State licensed architect or engineer.

### 7.2.3 Responder Organization

The emergency response to the attack was immediate. Within 3 min of the aircraft impact on WTC 1, PAPD was providing information on the attack to the police desk, FDNY had dispatched 26 units to the scene, and NYPD had called a department mobilization that included dispatching aviation units to the WTC for visual assessment. Within 10 min, PAPD had called a chemical mobilization; NYPD had dispatched five Emergency Service Unit (ESU) teams and had two aviation units at the scene providing observations. Within 30 min, 121 FDNY units had been dispatched to the scene and 30 units had signaled their arrival at the scene by pushing the “10-84” button on the vehicle’s communications console (Figure 7–6).

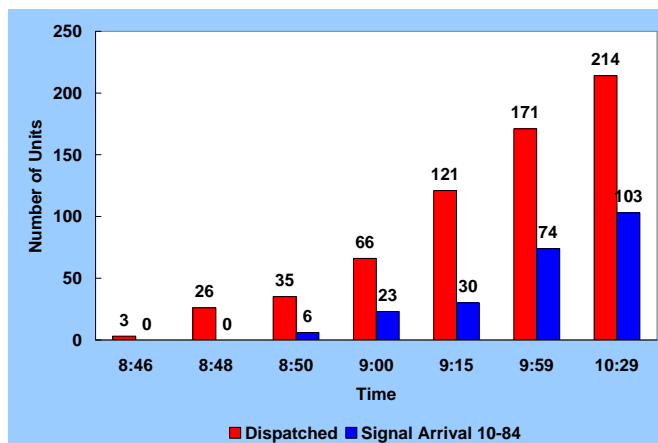

**Figure 7–6. Timing of FDNY unit arrivals.**

#### FDNY

Under New York City policy, since this was identified as a fire incident, FDNY was to be in control of the site. By 8:50, FDNY was operating from the Fire Command Desk in the lobby of WTC 1. Within minutes, the Incident Command Post was moved outside to West Street. The FDNY also maintained the lobby Command Post inside WTC 1 and established one in WTC 2. Additional command posts were established in the lobby of the Marriott Hotel (WTC 3) and on the corner of West and Liberty Streets.

Some of the first FDNY personnel on the scene had actually seen the aircraft hit the building and knew that the upper floors were badly damaged, including the building safety systems. They also saw the victims burned by the fireball that came into the building lobby. Upon meeting with Port Authority personnel and the previous WTC 1 Deputy Fire Safety Director, who had recently trained the new Fire Safety Director, to learn more about building conditions, FDNY personnel quickly made judgments related to building conditions and emergency response operations that were, in retrospect, highly accurate, for example:

- There were large fires burning on multiple floors at and above the impact zone.
- Smoke, fire, and structural damage in the buildings prevented many building occupants from evacuating floors above the impact zones.
- Many of the people trapped above the impact zones were already dead or would likely die before emergency responders could reach them.
- Localized collapses within and above the impact zones were possible due to the structural damage and fires.



- The elevators, some with people trapped inside, were generally not working and/or were not safe for use during the WTC operations.
- Firefighters would have to gain access to the injured and trapped occupants by climbing the stairs and carrying the equipment needed up the stairs.
- It would take hours to accumulate sufficient people and equipment to access the impact zones.
- The sprinkler and standpipe systems were compromised at the impact zone and firefighting would not be an option until a reliable water supply was established and equipment was carried up.
- Jet fuel had flowed into the elevator shafts and into other parts of the buildings and presented a danger to building occupants and emergency responder personnel.

Those in command decided that the response strategy was to enable the evacuation of those below the impact and fire zones. However, those directing initial operations inside the buildings followed an additional strategy: get sufficient people and equipment upstairs to cut a path through the fire and debris to rescue occupants above the fires. The strategy of company-level personnel, who were trained to fight fires and perceived this as a conventional, large high-rise fire, was to get to the fire floors and extinguish the fires.

Overlaying this trinity of operational strategies was the fact that this was the largest emergency response in FDNY history, with roughly 1,000 firefighters on the scene. Even the singularly large response to the 1993 bombing involved about 700 emergency personnel. A typical two-alarm fire might have involved about 100 personnel.

Thus, keeping track of what all these people were doing, where there were located, where they were going, and what they would do when they got there was a task without precedent. The principal tools for this were three 18 in. x 28 in. magnetic boards known as Fire Command Boards (Figure 7–7). They were located in the lobbies of WTC 1 and WTC 2 and at the Incident command Post on West Street. On each Board, magnetic identifiers of different colors identified engines, ladder and tower ladders, battalions, special units, and sectors. Unit numbers were written on the identifiers with marking pens. These Boards became overwhelmed after about 30 min due to the large number of people and units arriving at the scene. Some emergency personnel that arrived at the site did not report to the Command Posts or were not logged in on the Command Board. A formal analysis of arrivals and missions of the various units was compromised by the loss of the Boards in the collapse of the towers; there were no backup records.

## **NYPD**

The roles of the NYPD were to establish traffic control and perimeter security at the site, provide security for the command posts, and conduct evacuation and rescue operations within the towers. Their aviation units supplied observation capability and assessed the potential for roof rescue.

The primary mobilization point for the NYPD Special Operations Division (SOD) that sent Emergency Service Unit (ESU) rescue teams into the WTC was at the corner of Church and Vesey Streets at the



**Figure 7–7. Fire Command Board located in the lobby of WTC 1.**

northeast corner of the WTC tract. The post was managed by a SOD detective who had just gone off of duty and was still at his office when the attack occurred. He dispatched six ESU teams, each consisting of about five people. Records for each team were written on paper attached to a clipboard.

A second SOD mobilization point was established at the corner of West and Vesey Streets at the northwest corner of the WTC tract. The armed NYPD officers and ESU teams provided security for the FDNY Incident Command Post.

Since there were few NYPD units and since they typically arrived with all members, keeping track of the units was less problematic than for the FDNY. However, with the collapse of WTC 2, all written records were lost as the high winds and debris blew through the mobilization points. Since NYPD had only about 50 personnel operating in or near the towers, the managers of the mobilization points were able to easily reconstruct the lost data on their personnel.

Although The Port Authority had not endorsed a plan for roof rescue from the towers, it appeared to be one of the few options available for occupants trapped above the fires. NYPD helicopters reached the scene by 8:52 to assess the possibility of roof rescue. They were unable to land on the roof due to heavy smoke conditions. During the first hour, FDNY did not consider the option of roof rescue. When the aircraft struck WTC 2, it was clear that this was criminal activity, and the decision regarding roof top operations became the responsibility of NYPD. The NYPD First Deputy Commissioner ordered that no roof rescues were to be attempted, and at 9:43 a.m., this directive was passed to all units.

Roof rescue was not intended to be an option, and The Port Authority reported that it never advised tenants to evacuate upward. The Port Authority's standard full-building occupant evacuation procedures and drills required the use of stairways to exit at the bottom of the WTC towers. The standard procedures were to keep the doors to the roof locked. Roof access required use of an electronic swipe card to get through the first two doors and a security officer watching a closed-circuit camera on the 22nd floor of WTC 1 to open the third door via a buzzer. (The 1968 NYC Building Code required access to roofs like these, most likely to provide FDNY access. The 2003 code does not intend roof access to be used for evacuation and has no prohibition on locking this access.)

The NYPD and FDNY did not consider roof rescue a viable strategy for general evacuation. First, the NYPD and FDNY policies for roof operations were focused mainly on providing emergency responders with access into the building above the fire floors for firefighting, conventional rescue, and comforting occupants. Roof rescue was considered a measure of last resort to be used, for example, to assist occupants with medical emergencies. Second, although on September 11, an NYPD aviation unit was early on the scene to consider the possibility, smoke and heat conditions at the top of the towers prevented the conduct of safe roof operations, despite repeated attempts. Even if it had been possible for a helicopter to gain access to the roof, only a very small fraction of the large number of people trapped above the impact zone could have been rescued before the towers collapsed. Nonetheless, perhaps as an indication of the dire situation in the top floors of the towers, at least two decedents tried to get to the roof and found the roof access locked in both the WTC towers. Personnel at the WTC 1 Security Control Center on the 22<sup>nd</sup> floor attempted to electronically release the doors to the roof, but were unsuccessful due to damage to the computerized control system.

## **PAPD**

The roles of the PAPD were to establish security at the WTC and to conduct evacuation operations.

PAPD officers were performing their normal law enforcement duties at the WTC site when the attack on WTC 1 occurred. Several additional PAPD teams were dispatched from various locations from around the city and from Jersey City, with some arriving before the collapse of WTC 2 and reporting to PAPD personnel at the WTC 1 lobby Fire Command Desk. There were dozens of PAPD officers on site and on orders to report to the site. With the collapse of WTC 2, the PAPD Police Desk (in WTC 5) and the Command Center were evacuated. Many of the emergency response records were lost initially, but were recovered some days later.

## **Interdepartmental Interactions**

The coordination of communications and operations between the responding authorities at the WTC site was a challenge for all emergency responders working that morning. The short time duration between the initial attack and the collapse of the towers, coupled with the large number of responders and their staggered arrivals, compounded the difficulty of establishing a unified operation.

FDNY (and the Emergency Medical Services), NYPD, PAPD, The Port Authority, and OEM were attempting to work together. These efforts were stymied by a lack of existing protocols that clearly defined authorities and responsibilities, communications systems problems, and multiple major attacks and threats. Although there was merit to having the FDNY and NYPD Command Posts separated, there was no uniform means for communicating between the two Command Posts at the time when WTC 2 collapsed. FDNY and NYPD were primarily operating as independent organizations based on their operational responsibilities.

### **7.2.4 Responder Access**

Fighting fires in the upper levels of tall buildings is not the same as fighting fires in buildings that are less than 100 ft high. In the case of the WTC towers, the people needing assistance were mostly many stories above the ground, and climbing tens of flights of stairs was the only way upward for the emergency

responders. In the time available, they were not able to get very far. For example, emergency responders wearing police uniforms, not wearing Self-contained Breathing Apparatus (SCBA), and not carrying extra equipment, were able to climb the stairs at a rate of approximately 1.4 min per floor while climbing to floors in the 40s inside of WTC 1. The climbing rate for firefighters wearing protective clothing and SCBA and carrying extra firefighting and rescue equipment was about 2 min per floor. The downward flow of evacuees, especially those who had physical disabilities or were obese, also slowed the responders' progress, especially in the 44 in. wide stairwells. The flow of the evacuees caused teams of emergency responders to become separated, further disrupting team operations.

Neither the number of responders who entered the towers nor the floors they reached are known, due to the incompleteness of the Command Boards and their eventual destruction. From radio communications and first-person interviews, it appears that there were responders as high as floors in the 50s in WTC 1 and the 78<sup>th</sup> floor in WTC 2.

### **7.2.5 Communications**

There were multiple equipment systems for command-to-field communications, for responders to communicate among themselves, and for contact to and from building occupants:

- Landline telephone system (including access to the 9-1-1 system),
- Emergency announcement systems within WTC 1 and WTC 2,
- Cellular systems (including access to the 9-1-1 system),
- Warden phones (tower stair landings to Command Post),
- Firefighter phones, called standpipe phones, in the WTC towers, and
- FDNY handie-talkies, with booster support from a repeaters on WTC 5 and a Battalion car repeater located inside WTC 2.

Within WTC 1, the system used to make the emergency announcements was disabled by the first aircraft impact, communications to the elevators in the upper third of the buildings were lost, the Warden phones did not work, and attempts to use the landline phones to contact people upstairs were unsuccessful due to the failure of some phones in the building.

Little is known about the function of the internal communications inside WTC 2 after the aircraft struck the building. This is because all of the key emergency responders working inside WTC 2 died when the building collapsed. However, interviews with some occupants who evacuated from the building and interviews with emergency responders who communicated with counterparts inside WTC 2 indicated the following: some of the building's public address systems were working, some of the elevator phone systems were working, and some of the landline telephones were working. It is not known if the Warden Phone system was fully operational or if the standpipe phones were operational. Emergency responder communications inside WTC 2 primarily depended on radio and face-to-face communications.

The collapse of WTC 2 caused the cellular phone system in Lower Manhattan to fail. However, there were still landlines working in the city blocks adjacent to the WTC site, and calls were still emanating from inside WTC 1.

All of the radio systems analyzed were working well just before the attack on the WTC. However, PAPD, FDNY, and NYPD were aware that radio communications had not fared well in high-rise buildings, including WTC 1 following the 1993 bombing. The vast amount of metal and steel-reinforced concrete in high-rise buildings was known to attenuate and block radio signals, especially the low output power emergency responder handie-talkies. This was again a problem on September 11, 2001, when all three agencies encountered difficulties with their hand-held units.

Thus, there was a heavy burden placed on the FDNY repeater to boost the weak signals to a discernable level. The repeater was functional during operations at the WTC; apparently the antenna was not damaged by debris from the aircraft impacts. However, within WTC 1, the system did not function correctly. The cause of this malfunction could not be determined since the unit was destroyed in the collapse of WTC 1. Repeater recording communications suggest that it was used within WTC 2. The radio recordings showed that communications readability using the repeater channel was generally good to excellent. Where readability levels were poor, it was generally caused by multiple people attempting to communicate over the radio at one time. The heavy traffic continued until the repeater failed with the collapse of WTC 2.

Had communications using the repeater been adequate in WTC 1, there would have been opposing effects on the quality of operations and life safety. On the positive side, the emergency personnel in the tower would have been in at least some contact with the Command Posts. However, two serious counterpoints would have occurred. First, if the responders in both towers were using the same repeater at the same time, the traffic would have been heavier, and more of the calls would have been indecipherable. Second, a firefighter in either tower would have had difficulty discerning which communications related to operations in his tower. Given the inadequate markings within the towers and the unfamiliarity of some emergency responders with the site, there was already a high degree of confusion as to which tower a responder was in.

The poor radio communications at the WTC had a serious impact on the FDNY Command Post's attempts to maintain command and control in general. All emergency responders struggled with the high volume and low quality of radio communications traffic at the WTC, described as "radio gridlock." NIST estimates that one-third to one-half of the emergency responder radio communications were undecipherable or incomplete.

The poor communications had a critical effect on the conveyance of evacuation instructions. As early as 8:48, there was an order to WTC personnel to clear WTC 1. At 8:59 a.m., a senior PAPD officer called for the evacuation of the two towers. At 9:01 a.m., this was extended to the entire complex. This was before the second aircraft struck. At 9:04 a.m., WTC Operations told people to evacuate an unidentified building. At 10:06 a.m., an NYPD aviation unit reported that it wouldn't be much longer before WTC 1 would come down. Some survivors reported not having received any of these messages. It is not known how many others did not, nor whether their locations were such that they could have made it out of the buildings in time.

## **7.2.6 The Overall Response**

It was difficult to quantify the responders' degree of success. There were multiple reports of FDNY, NYPD, and PAPD efforts making the difference between death and survival. There were reports of assistance where the survival of the occupants was not determined. There were reports of firefighters quenching small fires on the lower floors of the towers and at the impact point in WTC 2. However, it would have been impossible for them to have had any significant effect on the fires that eventually led to the collapse of the structures.

## **7.3 FACTORS THAT CONTRIBUTED TO ENHANCED LIFE SAFETY**

### **7.3.1 Aggregate Factors**

- Reduced number of people in the buildings at the times of aircraft impact.
- Functioning elevators in WTC 2 for the 16 min prior to 9:02:59 a.m.
- Remoteness of Stairwell A from the impact zone and debris field.
- Participation of two-thirds of surviving occupants in recent fire drills.
- Upgrades to the life safety system components after the 1993 bombing.
- Evacuation assistance provided by emergency responders to evacuees.

### **7.3.2 Individual Factors**

- Location below the floor of impact.
- Shortness of delay in starting to evacuate.

## **PART III: THE OUTCOME OF THE INVESTIGATION**

---

This page intentionally left blank.



# Chapter 8

## PRINCIPAL FINDINGS

---

### 8.1 INTRODUCTION

This chapter presents the findings of the National Institute of Standards and Technology (NIST), organized according to the first three of the Investigation objectives for the World Trade Center (WTC) towers. The fourth objective is the subject of Chapter 9. WTC 7 is the subject of a companion report. The findings were derived from the extensive documentation summarized in the preceding chapters and described in detail in the accompanying reports. While NIST was not able to compile a complete documentation of the history of the towers, due to the loss of records over time and due to the collapses, the Investigators were able to acquire information adequate to support the findings and recommendations compiled in this chapter and the next. The chapter begins with summary statements and continues with the listing of the full set of principal findings.

### 8.2 SUMMARY

**Objective 1: Determine why and how WTC 1 and WTC 2 collapsed following the initial impacts of the aircraft.**

- The two aircraft hit the towers at high speed and did considerable damage to principal structural components (core columns, perimeter columns, and floors) that were directly impacted by the aircraft or associated debris. However, the towers withstood the impacts and would have remained standing were it not for the dislodged insulation and the subsequent multi-floor fires. The robustness of the perimeter frame-tube system and the large size of the buildings helped the towers withstand the impact. The structural system redistributed loads in places of aircraft impact, avoiding larger scale damage upon impact. The hat truss, which was intended to support a television antenna atop each tower, prevented earlier collapse of the building core. In each tower, a different combination of impact damage and heat-weakened structural components contributed to the abrupt structural collapse.
- In WTC 1, the fires weakened the core columns and caused the floors on the south side of the building to sag. The floors pulled the heated south perimeter columns inward, reducing their capacity to support the building above. Their neighboring columns quickly became overloaded as the south wall buckled. The top section of the building tilted to the south and began its descent. The time from aircraft impact to collapse initiation was largely determined by how long it took for the fires to weaken the building core and to reach the south side of the building and weaken the perimeter columns and floors.
- In WTC 2, the core was damaged severely at the southeast corner and was restrained by the east and south walls via the hat truss and the floors. The steady burning fires on the east side of the building caused the floors there to sag. The floors pulled the heated east perimeter columns inward, reducing their capacity to support the building above. Their neighboring

columns quickly became overloaded as the east wall buckled. The top section of the building tilted to the east and to the south and began its descent. The time from aircraft impact to collapse initiation was largely determined by the time for the fires to weaken the perimeter columns and floor assemblies on the east and south sides of the building. WTC 2 collapsed more quickly than WTC 1 because there was more aircraft damage to the building core, including one of the heavily loaded corner columns, and there were early and persistent fires on the east side of the building where the aircraft had extensively dislodged insulation from the structural steel.

- The WTC towers would likely not have collapsed under the combined effects of aircraft impact damage and the extensive, multi-floor fires that were encountered on September 11, 2001, if the thermal insulation had not been widely dislodged or had been only minimally dislodged by aircraft impact.
- In the absence of structural and insulation damage, a conventional fire substantially similar to or less intense than the fires encountered on September 11, 2001, likely would not have led to the collapse of a WTC tower.
- NIST found no corroborating evidence for alternative hypotheses suggesting that the WTC towers were brought down by controlled demolition using explosives planted prior to September 11, 2001. NIST also did not find any evidence that missiles were fired at or hit the towers. Instead, photographs and videos from several angles clearly showed that the collapse initiated at the fire and impact floors and that the collapse progressed from the initiating floors downward, until the dust clouds obscured the view.

**Objective 2: Determine why the injuries and fatalities were so high or low depending on location, including all technical aspects of fire protection, occupant behavior, evacuation, and emergency response.**

- Approximately 87 percent of the estimated 17,400 occupants of the towers, and 99 percent of those located below the impact floors, evacuated successfully. In WTC 1, where the aircraft destroyed all escape routes, 1,355 people were trapped in the upper floors when the building collapsed. One hundred seven people who were below the impact floors did not survive. Because the flow of people from the building had slowed considerably 20 min before the tower collapsed, the stairwell capacity was adequate to evacuate the occupants on that morning.
- In WTC 2, before the second aircraft strike, about 3,000 people got low enough in the building to escape by a combination of self-evacuation and use of elevators. The aircraft destroyed the operation of the elevators and the use of two of the three stairways. Eighteen people from above the impact zone found a passage through the damaged third stairway (Stairwell A) and escaped. The other 619 people in or above the impact zone perished. Eleven people who were below the impact floors did not survive. As in WTC 1, shortly before collapse, the flow of people from the building had slowed considerably, indicating that the stairwell capacity was adequate that morning. It is presumed that the 11 people did not escape for the same reasons as the victims in WTC 1.

- About 6 percent of the survivors described themselves as mobility impaired, with recent injury and chronic illness being the most common causes; few, however, required a wheelchair. Among the 118 decedents below the aircraft impact floors, investigators identified seven who were mobility impaired, but were unable to determine the mobility capability of the remaining 111.
- A principal factor limiting the loss of life was that the buildings were one-third to one-half occupied at the time of the attacks. NIST estimated that if the towers had been fully occupied with 20,000 occupants each, it would have taken just over 3 hours to evacuate the buildings using the stairs and about 14,000 people might have perished because the stairwell capacity would not have been sufficient to evacuate that many people in the available time. Egress capacity required by current building codes is determined by single floor calculations that are independent of building height and does not consider the time for full building evacuation.
- Due to the presence of assembly use spaces at the top of each tower that were designed to accommodate over 1,000 occupants per floor for the Windows on the World restaurant complex and the Top of the World observation deck, the New York City (NYC) Building Code would have required a minimum of four independent means of egress (stairs), one more than the three that were available in the buildings. Given the low occupancy level on September 11, 2001, NIST found that the issue of egress capacity from these places of assembly, or from elsewhere in the buildings, was not a significant factor on that day. It is conceivable that such a fourth stairwell, depending on its location and the effects of aircraft impact on its functional integrity, could have remained passable, allowing evacuation by an unknown number of additional occupants from above the floors of impact. Moreover, if the buildings had been filled to their capacity with 20,000 occupants, the required fourth stairway would likely have mitigated the insufficient egress capacity for conducting a full building evacuation within the available time.
- Evacuation was assisted by participation in fire drills within the previous year by two-thirds of survivors and perhaps hindered by a Local Law that prevented employers from *requiring* occupants to practice using the stairways. The stairways were not easily navigated in some locations due to their design, which included “transfer hallways” where evacuees had to traverse from one stairway to another location where the stairs continued. Additionally, many occupants were unprepared for the physical challenge of full building evacuation.
- The functional integrity and survivability of the stairwells was affected by the separation of the stairwells and the structural integrity of stairwell enclosures. In the impact region of WTC 1, the stairwell separation was the smallest over the building height—clustered well within the building core—and all stairwells were destroyed by the aircraft impact. By contrast, the separation of stairwells in the impact region of WTC 2 was the largest over the building height—located along different boundaries of the building core—and one of three stairwells remained passable after the aircraft impact. The shaft enclosures were fire rated but were not required to have structural integrity under typical accidental loads—there were numerous reports of stairwells obstructed by fallen debris from damaged enclosures.
- The active fire safety systems (sprinklers, smoke purge, fire alarms, and emergency occupant communications) were designed to meet or exceed current practice. However, with the

exception of the evacuation announcements, they played no role in the safety of life on September 11 because the water supplies to the sprinklers were damaged by the aircraft impact. The smoke purge systems, operated under the direction of the fire department after the fires, were not turned on, but they also would have been ineffective due to aircraft damage. The violence of the aircraft impact served as its own alarm. In WTC 2, contradictory public address announcements contributed to occupant confusion and some delay in occupants beginning to evacuate.

- For the approximately 1,000 emergency responders on the scene, this was the largest disaster they had ever seen. Despite attempts by the responding agencies to work together and perform their own tasks, the extent of the incident was well beyond their capabilities. Communications were erratic due to the high number of calls and the inadequate performance of some of the gear. Even so, there was no way to digest, test for accuracy, and disseminate the vast amount of information being received. In the opinion of some first responders, communications and information sharing cost the lives of some emergency responders. Their jobs were complicated by the loss of command centers in WTC 7 and then in the towers after WTC 2 collapsed. With nearly all elevator service disrupted and progress up the stairs taking about 2 min per floor, it would have taken hours for the responders to reach their destinations, assist survivors, and escape before the towers collapsed.

**Objective 3: Determine what procedures and practices were used in the design, construction, operation, and maintenance of WTC 1 and WTC 2.**

- Because of The Port Authority of New York and New Jersey's (Port Authority's) establishment under a clause of the United States Constitution, its buildings were not subject to any state or local building regulations. The buildings were unlike any others previously built, both in their height and in their innovative structural features. Nevertheless, the actual design and approval process produced two buildings that generally were consistent with nearly all of the provisions of the NYC Building Code and other building codes of that time that were reviewed by NIST. The loads for which the buildings were designed exceeded the New York City code requirements. The quality of the structural steels was consistent with the building specifications. The departures from the building codes and standards identified by NIST did not have a significant effect on the outcome of September 11.
- For the floor systems, the fire rating and insulation thickness used on the floor trusses were of concern from the time of initial construction. NIST found no technical basis or test data on which the thermal protection of the steel was based. However, on September 11, 2001, the minimum specified thickness of the insulation was adequate to delay heating of the trusses and the amount of insulation dislodged by the aircraft impact was sufficient to enable the critical heating of the structural steel.
- Based on four standard fire resistance tests that were conducted under a range of insulation and test conditions, NIST found the fire rating of the floor system to vary between 3/4 hour and 2 hours; in all cases, the floors continued to support the full design load without collapse for over 2 hours.

- The wind loads used for the WTC towers, which governed the design of the external columns, significantly exceeded the requirements of the NYC Building Code and other building codes of the day that were reviewed by NIST. Two sets of wind load estimates for the towers obtained by independent commercial consultants in 2002, however, differed by as much as 40 percent. These estimates were based on wind tunnel tests conducted as part of insurance litigation unrelated to the Investigation.

The tragic consequences of the September 11, 2001, attacks were largely a result of the fact that terrorists flew large jet-fuel laden commercial airliners into the WTC towers. Buildings for use by the general population are not designed to withstand attacks of such severity; building regulations do not require building designs to consider aircraft impact. In our cities, there has been no experience with a disaster of such magnitude, nor has there been any in which the total collapse of a high-rise building occurred so rapidly and with little warning.

While there were unique aspects to the design of the WTC towers and the terrorist attacks of September 11, 2001, there are several possibilities to improve the safety of tall buildings, occupants, and emergency responders that result from this investigation of commonly used procedures and practices that were used in the design, construction, operation, and maintenance of the WTC towers. There also are possible improvements for selected buildings that owners may determine to be at higher risk due to their iconic status, critical function, or design. The recommendations in Chapter 9 suggest a variety of ways in which to achieve these safety improvements.

## **8.3 FINDINGS ON THE MECHANISMS OF BUILDING COLLAPSE**

### **8.3.1 Summary of Probable Collapse Sequences**

WTC 1 was struck by a hijacked aircraft at 8:46:30 a.m. and began to collapse at 10:28:22 a.m. WTC 2 was struck by a hijacked aircraft at 9:02:59 a.m. and began to collapse at 9:58:59 a.m. The specific factors in the collapse sequences relevant to both towers (the sequences vary in detail for WTC 1 and WTC 2) are:

- Each aircraft severed exterior columns, damaged interior core columns and knocked off insulation from steel as the planes penetrated the buildings. The weight carried by the severed columns was distributed to other columns.
- Subsequently, fires began to grow and spread. They were initiated by the aircraft's jet fuel, but were fed for the most part by the building contents and the air supply resulting from breached walls and fire-induced window breakage.
- These fires, in combination with the dislodged insulation, were responsible for a chain of events in which the building core weakened and began losing its ability to carry loads.
- The floors weakened and sagged from the fires, pulling inward on the exterior columns.
- Floor sagging and exposure to high temperatures caused the exterior columns to bow inward and buckle—a process that spread across the faces of the buildings.

- Collapse then ensued.

Seven major factors led to the collapse of WTC 1 and WTC 2:

- Structural damage from the aircraft impact;
- Large amount of jet fuel sprayed into the building interior, that ignited widespread fires over several floors;
- Dislodging of SFRM from structural members due to the aircraft impact, that enabled rapid heating of the unprotected structural steel;
- Open plan of the impact floors and the breaking of the partition walls by the impact debris that resulted in increased ventilation;
- Weakened core columns that increased the load on the perimeter walls;
- Sagging of the floors, that led to pull-in forces on the perimeter columns; and
- Bowed perimeter columns that had a reduced capacity to carry loads.

### 8.3.2 Structural Steels

- Fourteen different strengths of steel were specified in the structural engineering plans, but only 12 steels of different strength were actually used in construction due to an upgrade of two steels. Ten different steel companies fabricated structural elements for the towers, using steel supplied from at least eight different suppliers. Four fabricators supplied the major structural elements of the 9<sup>th</sup> to the 107<sup>th</sup> floors. Material substitutions of higher strength steels were not uncommon in the perimeter columns and floor trusses.
- About 87 percent of the tested steel specimens (columns, trusses and bolts) met or exceeded the required yield strengths specified in design documents. About 13 percent had NIST-measured strengths that were slightly lower than the design values, but this may have arisen from mechanical damage during the collapse, the natural variability of structural steel, and slight differences between the NIST and original mill test report testing protocols.
- The safety of the WTC towers on September 11, 2001, was most likely not affected by the fraction of steel that, according to NIST testing, was modestly below the required minimum yield strength. The typical factors of safety in allowable stress design were capable of accommodating the measured property variations below the minimum.
- The pre-collapse photographic analysis showed that 16 recovered exterior panels were exposed to fire prior to collapse of WTC 1. None of the nine recovered panels from within the fire floors of WTC 2 were observed to have been directly exposed to fire.
- None of the recovered steel samples showed evidence of exposure to temperatures above 600 °C for as long as 15 min. This was based on NIST annealing studies that established the

set of time and temperature conditions necessary to alter the steel microstructure. These results provide some confirmation of the thermal modeling of the structures, since none of the samples were from zones where such heating was predicted.

- Only three of the recovered samples of exterior panels reached temperatures in excess of 250 °C during the fires or after the collapse. This was based on a method developed by NIST to characterize maximum temperatures experienced by steel members through observations of paint cracking.
- Perimeter columns exposed to fire had a great tendency for local buckling of the inner web; a similar correlation did not exist for weld failure.
- Observations of the recovered steel provided significant guidance for modeling the damage from the aircraft impact with the towers.
- For the perimeter columns struck by the aircraft, fractures of the plates in areas away from a welded joint exhibited ductile behavior (necking and thinning away from the fracture) under very high strain rates. Conversely, fractures occurring next to a welded joint exhibited little or no ductile characteristics.
- There was no evidence to indicate that the type of joining method, materials, or welding procedures were improper. The welds appeared to perform as intended.
- The failure mode of spandrel connections on perimeter panels differed above and below the impact zone. Spandrel connections on exterior panels at or above the impact zone were more likely to fail by bolt tear out. For those exterior panels below the impact zone, there was a higher propensity for the spandrels to be ripped off from the panels. This may be due to shear failures as the weight of the building came down on these lower panels. There was no difference in failure mode for the spandrel connections whether the exterior panels were exposed to fire or not.
- With the exception of the mechanical floors, the perimeter panel column splices failed by fracture of the bolts. At mechanical floors, where splices were welded in addition to being bolted, the majority of the splices did not fail.
- Core columns failed at both splice connection and by fracture of the columns themselves.
- The damage to truss seats on perimeter panels differed above and below the impact zone in both towers. The majority of recovered perimeter panel floor truss connectors (perimeter seats) below the impact floors were either missing or bent downward. Above this level, the failure modes were more randomly distributed.
- In the floor trusses, a large majority of the electric resistance welds at the web-to-chord connections failed. The floor truss and the perimeter panel floor truss connectors typically failed at welds and bolts.

- The NIST-measured properties of the steels (strain rate, impact toughness, high-temperature yield and tensile strengths) were similar to literature values for other construction steels of the WTC era.
- The creep behavior of the steels could be modeled by scaling WTC-era literature data using room temperature tensile strength ratios.

### 8.3.3 Aircraft Impact Damage Analysis

- Both towers withstood the significant structural damage to the exterior walls, core columns, and floor systems due to the aircraft impact. WTC 2 was the more severely damaged building and the first to collapse. WTC 2 displayed significant reserve capacity, as evidenced by a post-impact rooftop sway that was more than one-third of that under the hurricane force winds for which the building was designed. The oscillation period of this swaying was nearly equal to that calculated for the undamaged structure. (Such an analysis was not possible for the less severely damaged WTC 1 due to the absence of equivalent video footage for the analysis.)
- American Airlines Flight 11 impacted the north wall of WTC 1 at a speed of 443 mph  $\pm$  30 mph, banked 25 degrees  $\pm$  2 degrees to the left (left wing downward) and with the nose tilted slightly downward. United Airlines Flight 175 impacted the south wall of WTC 2 at a speed of 542 mph  $\pm$  24 mph, banked 38 degrees  $\pm$  2 degrees to the left (left wing downward) and with the nose pointed slightly downward and to the right.
- The aircraft impact on WTC 1 caused extensive damage to the north wall of the tower, principally in the regions impacted by the fuselage, engine, and fuel-filled wing sections. Photographic evidence showed that 34 perimeter columns were completely severed, while four columns were heavily damaged, and two columns were moderately damaged.
- The impact simulations of WTC 1 indicated that three to six core columns were severed, and three to four columns were heavily damaged. The floor trusses, core beams, and floor slabs experienced significant impact-induced damage on floors 94 through 96, particularly in the path of the fuselage. The wing structures were fragmented at the exterior wall, and aircraft fuel was dispersed on multiple floors. Aircraft debris substantially damaged the nonstructural interior partitions and the workstations and dislodged insulation in its path. The bulk of the fuel and aircraft debris was deposited in floors 93 through 97 with the largest concentration on floor 94.
- The aircraft impact on WTC 2 caused extensive damage to the south wall of the tower and to the regions impacted by the fuselage, engine, and fuel-filled wing sections. Photographic evidence showed that 29 perimeter columns were completely severed, one was heavily damaged, and three were moderately damaged. Four perimeter columns on the north wall also were severed.
- The impact simulations of WTC 2 indicated that five to ten core columns were severed and up to four columns were heavily damaged. The rupture of some column splices on floors 77, 80, and 83 contributed significantly to the failure of the core columns. The floor trusses, core



beams, and floor slabs experienced significant impact-induced damage on floors 79 to 81, particularly in the path of the fuselage. The analyses indicated that the wing structures were fragmented due to the interaction with the exterior wall and, as a result, aircraft fuel was dispersed on multiple floors. The aircraft debris substantially damaged the building's contents and also dislodged insulation in its path. The bulk of the fuel was concentrated on floors 79, 81, and 82, while the bulk of the aircraft debris was deposited in floors 78 through 80, with the largest concentration on floor 80.

- Other effects of the aircraft impacts included (a) severing of the sprinkler and fire hose water supply systems, negating any possible fire suppression efforts; (b) dispersing of jet fuel and ignition of building contents over large areas; (c) increasing the air supply into the damaged buildings that permitted very large fires; and (d) damaging ceilings, enabling unabated heat transport to the floor structure above and over the floor-to-ceiling partition walls to the next compartment. These effects were consistent with photographic evidence and with the accounts of building occupants and emergency responders.
- The simulations fairly closely matched the exterior wall damage patterns from each of the aircraft impacts and correctly predicted the collapse of five of the six stairwell walls and the lesser damage to the sixth, the trajectories of the engine and wheels that penetrated the buildings, and the accumulation of furnishings and debris in the northeast corner of the 80<sup>th</sup> and 81<sup>st</sup> floors of WTC 2.

#### 8.3.4 Reconstruction of the Fires

- In each tower, the fires were initiated simultaneously on multiple floors by ignition of some of the jet fuel from the aircraft. The initial jet fuel fires themselves lasted at most a few minutes.
- The principal combustibles on the fire floors were workstations. The total combustible fuel load on the WTC floors was about 4 lb/ft<sup>2</sup>. Higher combusted fuel loadings resulted in slower fire spread rates that did not match the patterns observed in the photographic evidence. Under these higher combusted fuel loadings, the fires likely would not have reached the south side of WTC 1 in the time needed to cause inward bowing and collapse initiation.
- The aircrafts added significant combustible material to their paths (and the paths of their breakup fragments) through the buildings.
- It is possible to reconstruct a complex fire in a large building, even if the building is no longer standing. However, this requires extraordinary information to replace what might have been gleaned from an inspection of the post-fire premises. In the case of the WTC tower, this information included floor plans of the fire zones, burning behavior of the combustibles, simulations of damage to the building interior, and frequent photographic observations of the fire progress from the building exterior.
- The fires in WTC 1 were generally ventilation limited, i.e., they burned and spread only as fast as windows broke. Where the combustibles were not significantly relocated by the aircraft debris, they tended to burn out in about 20 min. This was consistent with the results

of workstation fire tests conducted by NIST, in which the fuel load was 4 lb/ft<sup>2</sup>. Although there were multiple fires on some of the impact floors, the general trend was for the fires to move toward the south side of the tenant spaces.

- The fires in WTC 2 had sufficient air to burn at a rate determined by the properties of the combustibles. This was in large part due to the extensive breakage of windows in the fire zone by the aircraft impact. In contrast with WTC 1, there was little spread in WTC 2. The early fires persisted on the east side of the tower and particularly in the northeast corner of the 80<sup>th</sup> and 81<sup>st</sup> floors, where the aircraft debris had pushed a lot of fractured combustibles
- The Fire Dynamics Simulator can predict the room temperatures and heat release rate values for complex fires to within 20 percent, when the building geometry, fire ventilation, and combustibles are properly described.
- The Fire Structure Interface, developed for this Investigation, mapped the fire-generated temperature and thermal radiation fields onto and through layered structural materials to within the accuracy of the fire-generated fields and the thermophysical data for the structural components.
- Conventional office workstations reached a peak burning rate in about 10 min and continued burning for a total of about a half hour. Partial covering of surfaces with inert material reduced the peak burning rate proportional to the fraction covered, but did not affect the total amount of heat release during the entire burning.
- Jet fuel sprayed onto the surfaces of typical office workstations burned away within a few minutes. The jet fuel accelerated the burning of the workstation, but did not significantly affect the overall heat released.
- In the simulations, none of the columns with intact insulation reached temperatures over 300 °C. Only a few isolated truss members with intact insulation were heated to temperatures over 400 °C in the WTC 1 simulations and to temperatures over 500 °C in the WTC 2 simulations. In WTC 1, if the fires had been allowed to continue past the time of building collapse, complete burnout would likely have occurred within a short time since the fires had already traversed around the entire floor, and most of the combustibles would already have been consumed. In WTC 2, if the fire simulation were extended for 2 hours past the time of building collapse with all windows broken, the temperatures in the truss steel on the west side of the building (where the insulation was undamaged) would likely have increased for about 40 min before falling off rapidly as the combustibles were consumed. Temperatures of 700 °C to 760 °C were reached over approximately 15 percent of the west floor area for less than 10 min. Approximately 60 percent of the floor steel had temperatures between 600 °C and 700 °C for about 15 min. Approximately 70 percent of the floor steel had temperatures that exceeded 500 °C for about 45 min. At these temperatures, the floors would be expected to sag and then recover a portion of the sag as the steel began to cool. The temperatures of the insulated exterior and core columns would not have increased to the point where they would have experienced significant loss of strength or stiffness.

### 8.3.5 Structural Response and Collapse Analysis

- The core columns were weakened significantly by the aircraft impact damage and thermal effects. Thermal effects dominated the weakening of WTC 1. As the fires moved from the north to the south side of the core, the core was weakened over time by significant creep strains on the south side of the core. Aircraft impact damage dominated the weakening of WTC 2. With the impact damage, the core subsystem leaned to the southeast and was supported by the south and east perimeter walls via the hat truss and floors. As the core weakened, it redistributed loads to the perimeter walls through the hat truss and floors. Additional axial loads redistributed to the exterior columns from the core were not significant (only about 20 percent to 25 percent on average) as the exterior columns were loaded to approximately 20 percent of their capacity before the aircraft impact.
- The primary role of the floors in the collapse of the towers was to provide inward pull forces that induced inward bowing of perimeter columns (south face of WTC 1; east face of WTC 2). Sagging floors continued to support floor loads as they pulled inward on the perimeter columns. There would have been no inward pull forces if the floors connections had failed and disconnected.
- Column buckling over an extended region of the perimeter face ultimately triggered the global system collapse as the loads could not be redistributed through the hat truss to the already weakened building core. As the exterior wall buckled (south face for WTC 1 and east face for WTC 2), the column instability propagated to adjacent faces and caused the initiation of the building collapse. Perimeter wall buckling was induced by a combination of thermal weakening of the columns, inward pull forces from sagging floors, and to a much lesser degree, additional axial loads redistributed from the core.
- The WTC towers would likely not have collapsed under the combined effects of aircraft impact damage and the extensive, multi-floor fires that were encountered on September 11, 2001, if the thermal insulation had not been widely dislodged or had been only minimally dislodged by aircraft impact.
- In the absence of structural and insulation damage, a conventional fire substantially similar to or less intense than the fires encountered on September 11, 2001, likely would not have led to the collapse of a WTC tower.
- The insulation damage estimates were conservative as they ignored possibly damaged and dislodged insulation in a much larger region that was not in the direct path of the debris but was subject to strong vibrations during and after the aircraft impact. A robust criterion to generate a coherent pattern of vibration-induced dislodging could not be established to estimate the larger region of damaged insulation.
- For WTC 1, partitions were damaged and insulation was dislodged by direct debris impact over five floors (floors 94, 95, 96, 97, and 98) and included most of the north floor areas in front of the core, the core, and central regions of the south floor areas, and on some floors, extended to the south wall.

- For WTC 2, partitions were damaged and insulation was dislodged by direct debris impact over six floors (floors 78, 79, 80, 81, 82, and 83) and included the south floor area in front of the core, the central and east regions of the core, and most of the east floor area, and extended to the north wall.
- The adhesive strength of BLAZE-SHIELD D to steel coated with primer paint was found to be one-third to one-half of the adhesive strength to steel that had not been coated with primer paint. The SFRM products used in the WTC towers were applied to steel components with primer paint.
- The average thickness of the original thermal insulation on the floor trusses was estimated to be 0.75 in. with a standard deviation of 0.3 in. The average thickness of the upgraded thermal insulation was estimated to be 2.5 in. with a standard deviation of 0.6 in. Based on finite-element simulations, the thermal analyses for determining temperature histories of structural components used a thermally equivalent thickness of 0.6 in. and 2.2 in. for the original and upgraded insulation, respectively. For thermal analyses of the perimeter columns, spandrel beams, core beams, and core columns, the insulation on these elements was set to the specified thickness, due to a lack of field measurements.
- Based on four Standard Fire Tests conducted for various length scales, insulation thickness, and end restraints, the floor assemblies were shown to be capable of sagging without collapsing and supported their full design load under standard fire conditions for 2 hours or more without failure.
- For assemblies with a  $\frac{3}{4}$  in. SFRM thickness, the 17 ft assembly's fire rating was 2 hours; the 35 ft assembly's rating was  $1\frac{1}{2}$  hours. This result raised the question of whether or not a fire rating of a 17 ft floor assembly is scalable to the longer spans in the WTC towers.
- The specimen with  $\frac{1}{2}$  in. SFRM thickness and a 17 ft span would not have met the 2 hour requirement of the NYC Building Code.
- There is far greater knowledge of how fires influence structures in 2005 than there was in the 1960s. The analysis tools available to calculate the response of structures to fires are also far better now than they were when the WTC towers were designed and built.

## **8.4 FINDINGS ON FACTORS AFFECTING LIFE SAFETY**

### **8.4.1 Active Fire Protection**

- Active fire protection systems for many buildings are designed to the same performance specifications, regardless of height, size, and threat profile.
- The active fire protection systems (alarms, suppression, and smoke purging) in the WTC towers were designed to meet or exceed then-current practice. However, the successful operation of these systems depended upon the fire threat being consistent with what had been anticipated based upon previous experience and best engineering practices of the day.

- The fire alarm systems in the towers provided for automatic fire detection, but required manual activation of notification devices. On September 11, 2001, the impact of the aircraft itself alerted occupants in the WTC buildings to the unfolding danger when the first aircraft hit.
- Soon after the first aircraft impact, an overwhelming number of alarms were displayed at the Fire Command Station in WTC 1. The alarm systems were only capable of determining and displaying (a) areas that had at some time reached alarm point conditions and (b) areas that had not. The quality and reliability of information available to emergency responders at the Fire Command Station was not sufficient to understand the fire conditions.
- Although the fire alarm systems used multiple communication path risers, the systems experienced performance degradation, especially in WTC 1 where all fire alarm notification and communication functions appear to have been lost above the floors of impact.
- There was no means at the Fire Command Stations to determine whether or not announcements reached and could be heard on the intended floors.
- Alarm systems store information that is valuable for understanding the fire and smoke development in a building, but no information from the fire alarm systems was located, and there was no indication that anyone looked for it during the cleanup of the WTC site. Survivability of alarm systems data on computer hard drives, memory modules, or printouts in building fires and collapse environments is not addressed in present installation standards.
- Transmission of critical data outside the building to a monitoring station would provide means to preserve event data.
- Except for specific areas that were exempted from required sprinkler coverage, sprinkler systems were installed throughout the towers. As designed, the water supplies (storage tanks and pumped city water), automatic sprinklers, and standpipe/pre-connected hose systems met or exceeded the applicable installation requirements in the NYC Building Code. There were other design features that were considered inconsistent with engineering best practices, but no evidence was found to indicate that these features affected the events that occurred on September 11.
- All the fires that occurred in sprinklered spaces in the towers prior to September 11, 2001, were controlled with three or fewer sprinklers, in some cases supplemented by manual fire fighting.
- On the floors where the major fires occurred on September 11, 2001, the sprinkler system played no part since their water supply was damaged by the aircraft impact. The typical sprinkler system was installed with one connection to the sprinkler riser, providing a single point of failure of the water supply to the floor level sprinklers.
- The sprinkler systems could have provided fire control at coverage areas up to two or three times the specified design area of 1,500 ft<sup>2</sup>. However, 4,500 ft<sup>2</sup> constituted less than 15 percent of the area of a single floor in these buildings, and estimates of the extent of the

initial fires in WTC 1 and WTC 2 in 2001 were considerably greater than three times the specified design areas.

- There were redundant and sufficient supplies of water for the standpipe and sprinkler systems for control of normally expected fires on the floors where the September 11 fires occurred. Activating the secondary water supplies required manual operation of electric fire pumps by a sizable number of people at various locations.
- No information was available at the Fire Command Desk about the water supply in areas that were burning, leading to a Port Authority employee being sent up to assess the status.
- There was no information available regarding the performance of the non-aqueous fire suppression systems on September 11, 2001. The manually operated smoke purge systems were designed to be activated by the fire department after a fire was suppressed, and, therefore, were not initiated on September 11. It is unlikely the systems would have functioned as designed, due to loss of electrical power and damage to the HVAC shafts and other structural elements in the impact zone that were integral parts of the systems.
- Analysis indicated that the aircraft impact rupture of large return air shafts and related ductwork created a major path for vertical smoke spread in the towers.

#### **8.4.2 Evacuation**

- Approximately 87 percent of WTC occupants, and over 99 percent of those below the floors of impact, were able to evacuate successfully.
- At the time of the aircraft impacts, the towers were only about one-third to one-half occupied. Had they been at the full capacity of 20,000 workers and visitors per tower, computer egress modeling indicated that a full evacuation would have required just over 3 hours. Under those circumstances, about 14,000 occupants might have perished in the building collapses.
- There were  $8,900 \pm 750$  people in WTC 1 at 8:46 a.m. on September 11, 2001. Of those, 7,470 (or 84 percent) survived, while 1,462 to 1,533 occupants died.<sup>15</sup> At least 107 occupants were killed below the aircraft impact zone. No one who was above the 91<sup>st</sup> floor in WTC 1 after the aircraft impact survived. This was due to the fact that the stairwells and elevators were destroyed and helicopter rescue was impossible.
- There were  $8,540 \pm 920$  people in WTC 2 at 8:46 a.m. on September 11, 2001. Of those, 7,940 (or 93 percent) survived, while 630 to 701 occupants were killed.<sup>15</sup> Eleven of those killed were employed on floors located below the aircraft impact zone. Approximately 75 percent of the occupants above the 78<sup>th</sup> floor at 8:46 a.m. had successfully descended below the 78<sup>th</sup> floor prior to the aircraft impact at 9:03 a.m. The use of elevators and self-initiated evacuation during this period saved roughly 3,000 lives.

---

<sup>15</sup> As shown in Table 4–1, there were a total of 71 decedents whose initial locations in the towers were not certain: 30 below the impact zone in either WTC 1 or WTC 2, 24 at an unknown location in WTC 1 or WTC 2, and 17 people for whom no location information was available.

- The evacuation from WTC 2 occurred in spite of conflicting announcements, first urging people to return to their offices around 9:00 a.m., and then informing them around 9:02 a.m. that they may initiate an evacuation if conditions warranted. A subsequent announcement at 9:20 a.m., after the second aircraft strike, informed occupants that they could use the Concourse if they wished to leave the building. An announcement at 9:37 a.m. instructed occupants to go down the stairs.
- Stairwell A in WTC 2 remained passable for at least some period of time after the aircraft impact because (1) only the end of the left wing, empty of jet fuel, was in line with the stairwell; (2) Stairwell A was behind the structural/architectural core in the area of impact; and (3) the aircraft debris had to travel through the longer dimension of the core and thus was slowed by a greater number of columns, shafts, walls, and mechanical equipment, and (4) Stairwell A was widely separated from Stairwells B and C.
- Eighteen people successfully used the debris-cluttered Stairwell A in WTC 2 to leave the building after being on or above the 78<sup>th</sup> floor when United Airlines Flight 175 hit the building. It is possible that additional occupants from above the impact floors were making their way down the stairwell some minutes before building collapse.
- Two-thirds of the WTC 1 occupants and half of the WTC 2 occupants had started working at the WTC in the previous 4 years.
- Two-thirds of the WTC 1 and WTC 2 occupants participated in at least one fire drill in the twelve months prior to September 11, 2001. Nearly all (93 percent) of these occupants were instructed about the location of the nearest stairwell. However, only half of the survivors had previously used a stairwell, in part since NYC Local Law 5 prohibited requiring occupants to practice stairwell evacuation.
- The NIST Investigation found no evidence that the occupants of WTC 1 heard public address system announcements, although the fire command station was attempting to make such announcements.
- The delays of about 5 min in starting evacuation were largely spent trying to obtain additional information, trying to make sense of the situation, and generally preparing to evacuate.
- People who started their evacuation on higher floors took longer to start leaving and substantially increased their odds of encountering smoke, damage or fire. These encounters, along with interruption for any reason, had a significant effect on increasing the amount of time that people spent to traverse their evacuation stairwell.
- The WTC occupants were inadequately prepared to encounter horizontal transfers during the evacuation process and were occasionally delayed by the confusion as to whether a hallway led to a stairwell and confusion about whether the transfer hallway doors would open or be locked.
- The WTC occupants were often unprepared for the physical challenge of full building evacuation. Numerous occupants required one or more rest periods during stairwell descent.

- In WTC 1, the average surviving occupant spent approximately 48 seconds per floor in the stairwell, about twice that observed in non-emergency evacuation drills. The 48 seconds does not include the time prior to entering the stairwell, which was often substantial. Some occupants delayed or interrupted their evacuation, either by choice or instruction.
- Downward traveling evacuees reported slowing of their travel due to ascending emergency responders, but this counterflow was not a major factor in determining the length of their evacuation time. Emergency responders reported trouble ascending the stairs because of the volume of evacuees in the stairwells.
- During the last 20 min before each building collapsed, the evacuation rate in each building had slowed to about one-fifth the immediately prior evacuation rate. This suggests that for those seeking and able to reach and use the undamaged exits and stairways, the egress capacity was adequate to accommodate survivors.
- Many opportunities to communicate important information in a timely manner were missed, such as the general location of the impact region or whether to evacuate or not. As a result, building occupants, 9-1-1 operators, fire department dispatch, WTC building officials, and Port Authority personnel lacked necessary information about the situation.
- Faced with an uncertain situation, occupants of both buildings received conflicting feedback / advice from a variety of sources (including 9-1-1 operators, FDNY, family and friends, and The Port Authority) regarding whether to evacuate, whether to break windows, and the nature of their situation. It is likely that, in many instances, the people giving advice had as little accurate information as those seeking it.
- The decision to establish the primary evacuation route underground through the Concourse and then up to street level near WTC 5 prevented a significant number of injuries and/or deaths.
- Approximately 1,000 surviving occupants had a limitation that impacted their ability to evacuate, including recent surgery or injury, obesity, heart condition, asthma, advanced age, and pregnancy. The most frequently reported disabilities were recent injuries and chronic illnesses. The fraction of occupants requiring use of a wheelchair was very small.
- Mobility-impaired occupants were not universally accounted for by existing evacuation procedures, as some were left by colleagues (later rescued by strangers), some in WTC 1 were temporarily removed from the stairwells in order to allow more able occupants to evacuate the building, and others chose not to identify their mobility challenge to any colleagues.
- Most mobility-impaired individuals were able to evacuate successfully, often with assistance from co-workers or emergency responders, and it is not clear how many were among the 118 from below the impact floors who did not survive. It does not appear that mobility-impaired individuals were significantly over-represented amongst the decedents. As many as 40 to 60 mobility-impaired occupants and their companions were found on the 12<sup>th</sup> floor of



WTC 1 by emergency responders. About 20 of these were making their way down the stairs shortly before the building collapsed. It is not known how many from this group survived.

- Due to the presence of assembly use spaces at the top of each tower that were designed to accommodate over 1,000 occupants per floor for the Windows on the World restaurant complex and the Top of the World observation deck, the NYC Building Code would have required a minimum of four independent means of egress (stairs), one more than the three that were available in the buildings. Given the low occupancy level on September 11, 2001, NIST found that the issue of egress capacity from these places of assembly, or from elsewhere in the buildings, was not a significant factor on that day. It is conceivable that such a fourth stairwell, depending on its location and the effects of aircraft impact on its functional integrity, could have remained passable, allowing evacuation by an unknown number of additional occupants from above the floors of impact. Moreover, if the buildings had been filled to their capacity with 20,000 occupants, the required fourth stairway would likely have mitigated the insufficient egress capacity for conducting a full building evacuation within the available time.

### 8.4.3 Emergency Response

- New York City's emergency responders had never experienced an operation of the size presented by the attack on the WTC. They typically followed their department policies and procedures for the operations they were required to carry out. Under these procedures, almost all emergency responder departments established their command posts within the potential collapse zone of the buildings.
- In general, all departments attempted to work together to save as many lives as possible. This was done with no formal structure of unified command between departments below the Commissioner level of operations.
- Unified operations were hindered by the FDNY and NYPD command posts being separated. Department Chiefs could not directly communicate with each other using their handie-talkies and did not formulate unified orders and directions for their departments. Neither FDNY nor NYPD had liaison officers working with the other department's command posts until after WTC 1 collapsed.
- The first emergency responders were colleagues and regular building occupants. Acts of individual heroism saved many people whom traditional emergency responders would have been unable to reach in time.
- The initial fire department assessment of the situation was correct regarding the general magnitude of damage, the status of the water supply, and the further limitations imposed on firefighting by the height of the impact. FDNY command personnel learned from 9-1-1 dispatch operators that smoke, fire, and structural damage in the buildings prevented many building occupants from evacuating floors above the impact zones. The decision was quickly made that fire department efforts should be directed toward evacuation and rescue of building occupants and should not focus on firefighting.

- Only one elevator in each building was of use to the responders. To gain access to the injured and trapped occupants, firefighters had to climb the stairs, carrying the equipment with them.
- NIST estimated that emergency responder climbing rates varied between approximately 1.4 min per floor for personnel not carrying extra equipment to approximately 2.0 min per floor for personnel wearing protective clothing and carrying extra equipment.
- Intense smoke and heat conditions on the top of the two WTC buildings prevented the NYPD helicopters from conducting roof evacuations.
- NYPD aviation unit personnel reported critical information about degrading building conditions before WTC 2 collapsed and critical information about the impending collapse of WTC 1 several minutes prior to its collapse. No evidence has been found to suggest that the information was further communicated to all emergency responders at the scene.
- There were roughly 1,000 emergency responders on the site. The Command Board approach to managing operations became overwhelmed with this large number of personnel and units reporting in for operations. The responding units generally followed good practices as related to accountability of staff. However, there were cases where individuals and ambulances did not report to the Command Posts. There was no way to locate or track units and individuals once they had departed to accomplish their tasks.
- Generally, the equipment used by the emergency responders was adequate for the operations being carried out. Flashlights were valuable, since the stairwells were generally dark and many areas were opaque with smoke and dust, especially in WTC 1 after the collapse of WTC 2. Self-contained breathing apparatus enabled responders to breathe when they were in the zones where the air was contaminated.
- For PAPD and NYPD, radio equipment did not appear to be a major problem during the operations. The PAPD's new radio antenna system provided it with a reasonable quality of radio communications until the collapse of WTC 2, at which time personnel were forced to switch to point-to-point communications. NYPD experienced successful operations with its radio equipment, mainly since only a few entered the WTC towers and the location of the mobilization point (a city block or more away from the towers) provided an unobstructed line of sight route for radio signals to enter and exit the building's windows.
- The overall emergency response was hampered by the loss of the Office of Emergency Management Command Center.
- The FDNY Incident Command Desk was hampered by the lack of a fully functional Field Communications unit, poor radio communications, and limited access to shared information critical to operations.
- The FDNY radio system was inadequate for locating and tracking the large number of personnel at the site. The FDNY relied heavily on hand-held units and knew that even the new handie-talkie radios did not work well in high-rise buildings where the signals were attenuated by the large amounts of metal and steel-reinforced concrete. Thus, the location of

Command Posts inside the buildings made calls to them subject to attenuation. Nonetheless, there were reports by emergency responders that their radios played a part in saving their lives.

- Radio communications overload quickly became a problem. After the first aircraft strike, there was a factor-of-five increase in emergency responder radio communications. This resulted in situations where the base station radio operators were unable to relay important information. Approximately 1/3 to 1/2 of the emergency radio communications were not complete messages or were not understandable.
- Communications within, from, and to WTC 1 were problematic. The building emergency communications system used to make the emergency announcements inside was inoperable as a result of the aircraft impact. The warden and standpipe phone systems were also not operating. The radio repeater in WTC 5, though found to be operational, was not effective in WTC 1. Eventually, only about half of the responders located in WTC 1 heard radio messages calling for the immediate evacuation of the building. Emergency responders who had the evacuation information told others.
- The WTC 5 repeater appeared to be effective in WTC 2. The Battalion Car Cross-band Repeater, recently developed by the FDNY and taken to the lobby of WTC 2, was used as a backup.
- Information overload led to an inability to pool and analyze information in real time and to distribute it to the emergency responders and the WTC occupants in a timely fashion. As a result, many emergency responders did not get the critical information they needed to maintain good situational awareness. Some occupants did not get information that potentially could have saved their lives, such as notification that Stairwell A was possibly passable from above the impact zone.
- A preponderance of evidence indicted that lack of timely information sharing and inadequate communication capabilities likely contributed to the loss of emergency responder lives.
- The collapse of WTC 2 totally disrupted the ongoing Incident Command System Operations being carried out by FDNY, NYPD, and PAPD.
- The private ambulances and Emergency Medical Service teams that responded to the WTC had limitations to their effectiveness. They had no protective clothing. They did not have the same radios, so the other agencies could not communicate with them. Only paper records were kept of patients being treated by official and self-dispatched emergency medical units. These records were lost when the buildings collapsed.
- Communications between the emergency response agencies and the media were problematic. Critical life safety and evacuation information from the WTC towers was not communicated to the news media so that it could be broadcast to people trapped inside the WTC towers above the building fires. By bypassing the appropriate emergency response agency contact points, some media firms interfered with the on-site operations.

## 8.5 FINDINGS ON OPERATIONAL CODES, STANDARDS, AND PRACTICES

### 8.5.1 General

- Although not required to conform to NYC codes, The Port Authority adopted the provisions of the proposed 1968 edition of the NYC Building Code, more than three years before it went into effect. The proposed 1968 edition allowed Port Authority to take advantage of less restrictive provisions and of technological advances compared with the 1938 edition, which was in effect when design for the WTC towers began in 1962.
- The NYC Department of Buildings reviewed the WTC tower drawings in 1968 and provided comments to The Port Authority concerning the plans in relation to the 1938 NYC Building Code. The architect-of-record submitted to The Port Authority responses to those comments, noting how the plans conformed to the 1968 NYC Building Code
- In 1993, The Port Authority and the NYC Department of Buildings entered into a memorandum of understanding that restated The Port Authority's longstanding policy to ensure that its facilities in the City of New York meet and, where appropriate, exceed the requirements of the NYC Building Code.
- The Port Authority was not required to yield, and appears not to have yielded, jurisdictional authority for regulatory and enforcement oversight to the New York City Department of Buildings. The Port Authority was created as an interstate entity, under a clause of the U.S. Constitution permitting compacts between states, and is not bound by the authority of any local or state jurisdiction.
- It was remarkable that the Investigation Team was able to obtain the large quantity of documentation of the construction and subsequent modification of the WTC towers. Such documents are normally not archived for more than about 6 years to 7 years, with no requirements for storage remote from the building. In the case of the WTC towers, The Port Authority and its contractors and consultants maintained an unusually comprehensive set of documents, a dominant portion of which had not been destroyed in the collapse of the buildings but was assembled and provided to the Investigation Team.
- The Architect of Record was responsible for specifying the fire protection and designing the evacuation system. There was not, and still is not, a requirement for a fire protection engineer to be part of the process. In the case of the WTC towers, the building owner played a significant role in specifying the fire protection and evacuation systems.
- The current state-of-practice is not sufficiently advanced for engineers to routinely analyze the performance of a whole structural system under a prescribed design-basis fire scenario.
- Buildings were not (and still are not) specifically designed to withstand the impact of fuel-laden commercial aircraft, and building codes in the United States do not require building designs to consider aircraft impact.

- While two documents from The Port Authority indicated that the safety of the WTC towers and their occupants in an aircraft collision was a consideration in the original design, it appears that the effect of the subsequent fires was not considered. NIST was unable to locate any documentary evidence on the aircraft impact analysis considered by The Port Authority.

### 8.5.2 Structural Safety

- At the time of the design and construction of the WTC towers, there were no explicit structural integrity provisions to mitigate progressive collapse. U.S. Federal agencies and the United Kingdom have since developed and implemented such guidelines. New York City adopted by rule in 1973 a requirement for buildings to resist progressive collapse under extreme local loads. The rules apply specifically to buildings that used precast concrete wall panels and not to other types of buildings.
- At the time of the design and construction of the WTC towers, there were no explicit minimum structural integrity provisions for the means of egress (stairwells and elevator shafts) in the building core that were critical to life safety. The building core, generally designed to be part of the vertical gravity load-carrying system of the structure, need not be part of the lateral load-carrying system of the structure. In this case, the structural designer may have preferred the use of partition walls rather than structural walls in the core area to reduce building weight. In the case of the WTC towers, the core had 2 hour fire-rated, gypsum partition walls with little structural integrity, and the core framing was required to carry only gravity loads. Had there been a minimum structural integrity requirement to satisfy normal building and fire safety considerations, it is conceivable that the damage to stairways, especially at the floors of impact, may have been less extensive.
- Wind loads were a major factor in the design of structural components that made up the frame-tube steel framing system. Building codes allow the determination of wind forces from wind tunnel tests for use in design, but there were not (and still are not) standards for conducting wind tunnel tests and for the methods used in practice to estimate design wind loads from test results. Results of two sets of wind tunnel tests conducted for the WTC towers in 2002 by independent commercial laboratories as part of insurance litigation, and voluntarily provided to NIST by the parties to the litigation, show up to 40 percent differences in resultant forces on the structures. There were also significant differences among various specified design wind speeds. Such disparities are indicative of the limitations associated with the current state of practice in wind engineering for tall buildings.
- The original design wind loads on the towers exceeded those established in the prescriptive provisions of the NYC Building Code from 1968 through 2001. These wind loads were also higher than those required by other selected building codes and the relevant model building code of the time. Note, however, that the approach in these codes was oversimplified, and as a result, these codes may not be applicable for super-tall building design.
- In the original design of the towers, the calculated drift (the maximum sway of the building) was significantly larger than what is currently used in practice. However, drift was not, and is not, a design factor prescribed in building codes.

- The demand/capacity ratios (DCRs) of the columns, estimated from the original WTC design loads, were in general close to those obtained under current wind design practice. The DCRs for over 99 percent of the floor trusses and beams were less than unity as they should have been. The safety of the WTC towers on September 11, 2001 was most likely not affected by the fraction of structural members for which the demand exceeded allowable capacity due to: (1) the factor of safety in the allowable stress design method, (2) the load redistribution capability of the steel structures, and (3) the towers having been subjected to lighter than routine live loads and minimal wind loads at the time of the attacks.
- Under a combination of the original WTC design dead and wind loads, tension forces were developed in the exterior walls of both towers. The forces were largest at the base of the building and at the corners. The Investigation showed that the DCRs for the exterior wall splice connections were less than 1.0.
- For the towers' resistance to shear sliding under wind loads, the factor of safety was between 10 and 11.5, while the factor of safety against overturning ranged from 1.9 to 2.7 for both towers.
- The period of natural building oscillations calculated from the reference global model of the WTC 1 matched well those determined from accelerometers located atop the tower. This lent credence to the global models of the towers.

### 8.5.3 Fire Safety

- By being consistent with the proposed 1968 edition of the NYC Building Code, rather than the requirements of the 1938 Code, the tower design:
  - Eliminated a fire tower<sup>16</sup> (also called a smoke-proof stairway) as a required means of egress;
  - Reduced the number of required stairwells from 6 to 3 (see discussion in Section 5.35) and the size of doors leading to the stairs from 44 in. to 36 in.;
  - Reduced the fire rating of the shaft walls in the building core from 3 hours to 2 hours; and
  - Permitted a 1 hour reduction in fire rating for all structural components (columns from 4 hours to 3 hours and floor framing members from 3 hours to 2 hours) by allowing the owner/architect to select Class 1B construction for business occupancy and unlimited building height.

Many of these allowances in the 1968 NYC Building Code are contained in current codes.

---

<sup>16</sup> A fire tower (also called a smoke-proof stair) is a stairway that is accessed through an enclosed vestibule that is open to the outside or to an open ventilation shaft providing natural ventilation that prevents any accumulation of smoke without the need for mechanical pressurization.

- In 1993, The Port Authority adopted a policy providing for implementation of fire safety recommendations made by local government fire departments after a fire safety inspection of a Port Authority facility and for the prior review by local fire safety agencies of fire safety systems to be introduced or added to a facility. Later that year, The Port Authority entered into an agreement with FDNY that reiterated the policy adopted by The Port Authority, recognized the right of FDNY to conduct fire safety inspections of Port Authority properties in the City of New York, provided guidelines for FDNY to communicate needed corrective actions to The Port Authority, ensured that new or modified fire safety systems are in compliance with local codes and regulations, and required third-party review of such systems by a New York State licensed architect or engineer.
- Compartmentation of spaces is a key building fire safety requirement to limit fire spread. The WTC towers initially had 1 hour fire-rated partitions separating tenants (demising walls) that extended from the floor to the suspended ceiling, not the floor above (the ceiling tiles were not fire rated). Over the years, these partitions were replaced with partitions that were continuous from floor to floor (separation wall), consistent with the 1968 NYC Building Code. Some partitions had not been upgraded by 1997, and a consultant recommended to The Port Authority that it develop and implement a survey program to ensure that the remediation process occurred as quickly as possible. It appears that with few exceptions, nearly all of the floors not upgraded were occupied by a single tenant. The Port Authority adopted guidelines in 1998 that required such partitions to provide a continuous fire barrier from top of floor to underside of slab.
- No technical basis was found for selecting the sprayed fire-resistive material (SFRM) used or its thickness for the large-span open-web floor trusses of the WTC towers. The assessment of the insulation thickness needed to meet the 2 hour fire rating requirement for the untested WTC floor system evolved over time:
  - In October 1969, The Port Authority directed the insulation contractor to apply 1/2 in. of insulation to the floor trusses.
  - In 1999, The Port Authority issued guidelines requiring that insulation be upgraded to 1 1/2 in. for full floors undergoing alterations.
  - Unrelated to the WTC buildings, an International Conference of Building Officials (ICBO) Evaluation Service report (ER-1244), re-issued June 1, 2001, using the same SFRM recommends a minimum thickness of 2 in. for “unrestrained steel joists” with “lightweight concrete” slab.
- There was no code provision that specifically required the conduct of a fire resistance test if adequate data did not exist from other building components and assemblies to qualify an untested building element. Instead, several alternate methods were permitted, with limited guidance on detailed procedures to be followed. Both the Architect of Record (in 1966) and the Structural Engineer of Record (in 1975) stated that the fire rating of the floor system of the WTC towers could not be determined without testing. NIST did not find evidence indicating that such a test was conducted to determine the fire rating of the WTC floor system. The Port Authority informed NIST that there are no such test records in its files.

- Neither the 1968 edition of the NYC Building Code, which was used in the design of the WTC towers, nor the 2001 edition of the code, adopted the “structural frame” requirement. Use of the “structural frame” approach, in conjunction with the prescriptive fire rating, would have required the floor trusses, the core floor framing, and perimeter spandrels in the WTC towers to be 3 hour fire-rated, like the columns for Class 1B construction in the 1968 NYC Building Code. This approach, which appeared in the Uniform Building Code (a model building code) as early as 1953, was carried into the 2000 International Building Code (one of two current model codes). The WTC floor system was essential to the stability of the building as a whole since it provided lateral stability to the columns and diaphragm action to distribute wind loads to the columns of the frame-tube system.
- There was, and is, no technical basis to establish whether the construction classification and fire rating requirements were risk-consistent with respect to the design-basis hazard and the consequences of that hazard. For tall buildings, the likely consequences of a given threat to an occupant on the upper floors are more severe than the consequences to an occupant on the first floor, especially considering more difficult access by firefighters and increased time required for stairwell evacuation. There were, and are, no additional categories for tall buildings, where different building classification and fire ratings requirements may be appropriate.
- There were no field application and inspection requirements to ensure that the as-built condition of the passive fire protection, such as SFRM, conformed to conditions found in fire resistance tests of building components and assemblies. This includes determination of whether the as-applied average insulation thickness and variability was thermally equivalent to the specified minimum fire proofing thickness. (Currently, the NYC Building Code and the IBC require inspection of the SFRM, although self-certification is becoming common. NFPA 5000 requires a quality assurance program.) In addition, requirements were not available for in-service inspections of passive fire protection during the life of the building. The adequacy of the insulation of the WTC towers posed an issue of some concern to The Port Authority over the life of the buildings.
- Structural design did not, and does not, consider fire as a design condition, as it does the effects of dead loads, live loads, wind loads, and earthquake loads. Current prescriptive code provisions are based on tests that provide *relative* ratings of fire resistance. These may be adequate for simple structures and for comparing the relative performance of structural components in more complex structures. The state-of-the-art did not enable evaluation of the actual performance (i.e., load-carrying capacity) in a real fire of the structural components, or the structure as a whole system, including the connections between components.
- The provisions that were used for the WTC towers did not require specification of a fire-rating requirement for connections separate from those for the connected elements. The Investigation Team was unable to determine the fire rating of a connection where the connected elements had different fire ratings, and whether the applied insulation achieved that rating.
- There was, and is, no technical basis to establish whether the minimum mechanical and durability related properties of SFRM were sufficient to ensure acceptable in-service



performance in buildings. This includes the ability of such materials to withstand typical shock, impact, vibration, or abrasion effects over the life of a building. There are now measurement methods for many of these properties, but the relationship of the results to serviceability requirements is in need of technical support.

- There were no validated tools to analyze the dynamics of building fires and their effects on the structural system that would have allowed engineers to evaluate structural performance under alternative fire scenarios and fire protection strategies. While considerable progress has been made in recent years, significant work remains to be done before adequate tools are available for use in routine practice. NIST had to further develop and validate tools to investigate the fire performance of the WTC towers.
- Building code provisions for sprinkler installation in office buildings were an option in lieu of compartmentation. NYC has since promulgated local laws to encourage installation of sprinklers in new buildings, and is now considering a law to require sprinklers in existing buildings. The WTC towers were fully sprinklered by 2001, about 30 years after their construction.
- Active smoke management systems and/or combination fire/smoke dampers were not required in fully sprinklered buildings by the 1968 NYC Building Code or any subsequent, retroactive provisions.
- With a few special exceptions, building codes in the United States did not, and do not, require the use of fire-protected elevators for routine emergency access by first responders or as a secondary method (after stairways) for full building evacuation of occupants in emergencies.
- Firefighters moving up the stairs did not significantly lengthen the average time evacuees spent in the stairways. However, the climbing rate of the firefighter was hampered by the presence and movement of the evacuees.
- The separation of the three stairwells in each tower exceeded the requirements of the 1968 NYC Building Code. On some floors, the separation distances were not as large as the current model building codes require, while on other floors, the separation distances significantly exceeded the provisions in those codes.

## 8.6 FUTURE FACTORS THAT COULD HAVE IMPROVED LIFE SAFETY

In the course of the Investigation, NIST and its contractors were aware that there were modern, emerging, or even imagined capabilities that could have increased the survival rate of those in the WTC towers, had they been in place on September 11, 2001. These are listed here, not posed as recommendations for implementation, but presented for completeness in the portrayal of the findings of the Investigation. NIST has not conducted studies to evaluate the degree to which building performance and human factors could have been improved on September 11, 2001, had the capabilities been available.

### **8.6.1 Building Performance Factors**

- Thermal insulation that bonds more firmly to structural steel.
- Perimeter column and floor framing with greater mass to enhance thermal and buckling resistance.
- Improved compartmentation and stairwell enclosures.
- Thermally resistant window assemblies to limit the air supply and retard fire growth.
- Steels with improved high temperature properties, especially with regard to creep.
- Fire protected and structurally hardened elevators for use in occupant evacuation and responder access.

### **8.6.2 Human Performance Factors**

- More accurate and reliable communications among emergency responders and building occupants.
- Better management of large-scale emergency incidents.
- Better evacuation training.
- Self-evacuation capability for the mobility impaired.

## Chapter 9

# RECOMMENDATIONS

---

### 9.1 BUILDING REGULATIONS

As described in Chapter 5, codes and standards for the design, construction, operation, and maintenance of buildings are the documents by which a society states its intent to provide public safety and functionality. In the United States, building and fire safety regulations, promulgated and enforced by state and local jurisdictions, are based on model codes developed by private sector organizations—the International Code Council (ICC) and the National Fire Protection Association (NFPA). At present (June 2005), all or parts of 45 states plus the District of Columbia use the ICC’s *International Building Code*, while 36 states plus the District of Columbia use the ICC’s *International Fire Code*. Similarly, NFPA’s *National Electrical Code* is used in virtually all jurisdictions. With the exception of standards for manufactured housing, the federal government’s role in determining specific codes is mandatory only for federally owned, leased, regulated, or financed facilities.

The model codes adopt by reference voluntary consensus standards that are developed by a large number of private sector standards development organizations (SDOs). The SDOs include NFPA, ASTM International, the American Society of Civil Engineers (ASCE), the American Institute of Steel Construction (AISC), the American Concrete Institute (ACI), and the American Forest & Paper Association (AF&PA). The processes used by these organizations are accredited by the American National Standards Institute (ANSI), which administers and coordinates the U.S. voluntary standardization and conformity assessment system.

In addition to standards and codes organizations, there are other key stakeholder groups that either are responsible for or influence the practices used in the design, construction, operation, and maintenance of buildings in the United States. These typically include organizations representing building owners and managers (e.g., Building Owners and Managers Association, Construction Industry Institute), real estate developers (e.g., Real Estate Board of New York), contractors (e.g., Associated General Contractors, Associated Builders and Contractors), architects (e.g., American Institute of Architects), engineers (e.g., National Society of Professional Engineers, Society of Fire Protection Engineers, Structural Engineering Institute, National Council of Structural Engineering Associations), suppliers, and insurers. These groups also provide training, especially as it affects the ability to implement code provisions in practice. Lack of adequate training programs can limit the usefulness or widespread acceptance of improved code provisions. Very few members of the general public and building occupants participate in this process.

The National Conference of States on Building Codes and Standards (NCSBCS)—a body of the National Governors Association and the Council of State Governments—includes members representing chief building regulatory officials of the states and local code officials from across the nation. While NCSBCS does not develop or implement building codes, it provides a national forum to discuss issues related to codes, standards, and practices that cut across jurisdictional boundaries.

The National Institute of Standards and Technology (NIST) is a nonregulatory agency of the U.S. Department of Commerce. *NIST does not set building codes or standards, but provides technical support to the private sector and to other government agencies in the development of U.S. building and fire practice, standards and codes.* NIST provides this support by conducting research which helps to form the technical basis for such practice, standards, and codes; disseminating research results to practicing professionals; having its staff participate on technical and standards committees; and, providing technical assistance to the building and fire safety communities.

*Rigorous enforcement of building codes and standards by state and local agencies, well trained and managed, is critical in order for standards and codes to ensure the expected level of safety. Unless they are complied with, the best codes and standards cannot protect occupants, emergency responders, or buildings.*

## **9.2 NIST'S RECOMMENDATIONS FOR IMPROVING THE SAFETY OF BUILDINGS, OCCUPANTS, AND EMERGENCY RESPONDERS**

NIST conducted its building and fire safety investigation of the World Trade Center (WTC) disaster of September 11, 2001, under the authority of the National Construction Safety Team Act (15 USC 7301 et seq.). The National Construction Safety Team's final report is required by the Act to include recommendations that address (1) specific improvements to building standards, codes, and practices, (2) changes to, or the establishment of, evacuation and emergency response procedures, and (3) research and other appropriate actions needed to help prevent future building failures.

As part of its WTC Investigation, NIST is issuing 30 recommendations that identify specific improvements in the way buildings are designed, constructed, maintained, and used and in evacuation and emergency response procedures.

- NIST believes that these recommendations are both realistic and achievable within a reasonable period of time and that their implementation would make buildings safer for occupants and emergency responders in future emergencies.
- NIST strongly urges that immediate and serious consideration be given to these recommendations by the building and fire safety communities—especially designers, owners, developers, codes and standards development organizations, regulators, fire safety professionals, and emergency responders.
- NIST also strongly urges building owners and public officials to (1) evaluate the safety implications of these recommendations to their existing inventory of buildings, and (2) take the steps necessary to mitigate any unwarranted risks without waiting for changes to occur in codes, standards, and practices.

NIST has assigned top priority to work vigorously with these communities to ensure that there is a complete understanding of the recommendations and their technical basis and to provide needed technical assistance. As part of this effort, NIST will develop and maintain a web-based system with information on the status of NIST's recommendations that will be available to the public so that progress in implementing them can be tracked.

In formulating its recommendations from the WTC Investigation, NIST considered:

- The relevant commonly used procedures and practices<sup>17</sup> and established baseline performance for the buildings, evacuation, and emergency response;
- The performance on September 11, 2001, compared to the baseline performance;
- Findings related to building performance, evacuation and emergency response, and to procedures and practices used in the design, construction, operation, and maintenance of the buildings;
- Whether these findings relate to the unique circumstances surrounding the terrorist attacks of September 11, 2001, or to normal building and fire safety considerations (including evacuation and emergency response);
- Technical solutions that are needed to address potential risks to buildings, occupants, and emergency responders, considering both identifiable hazards and the consequences of those hazards; and
- Whether the risks apply to all buildings or are limited to certain building types (e.g., buildings that exceed a certain height and floor area or that employ a specific type of structural system), buildings that contain specific design features, iconic/signature buildings, or buildings that house critical functions.

The 30 recommendations resulting from the NIST Investigation were prepared by the Investigation Team with benefit of review by the National Construction Safety Team Advisory Committee and the public. These improvements are to be achieved both by complying with existing codes and through provisions that address new requirements. Table 9–1 (which follows the recommendations) shows a crosswalk between the recommendations in each of eight groups and three categories. The topics addressed in each group of recommendations are:

1. Increased structural integrity, including methods for preventing conditions that could result in progressive collapse (when a building or a significant portion of a building collapses due to disproportionate spread of an initial local failure), standardizing the estimation of wind loads that frequently govern the design of tall buildings, and enhancing the stability of tall buildings.
2. Enhanced fire endurance of structures, including the technical basis for determining construction classification and fire resistance ratings, improvements to the technical basis for standard fire resistance testing methods, adoption of the “structural frame” approach to fire resistance ratings, and in-service performance requirements and conformance assessment criteria for spray-applied fire-resistive materials.
3. New methods for designing structures to resist fires, including the objective of burnout without collapse, the development of performance-based methods as an alternative to current prescriptive

---

<sup>17</sup> While there were unique aspects to the design of the WTC towers and the terrorist attacks of September 11, 2001, the design, construction, operation, and maintenance of the WTC towers—and the emergency response to the WTC towers—were based on procedures and practices that were commonly used for normal conditions.

design methods, the development and evaluation of new fire-resistive coating materials and technologies, evaluation of the fire performance of conventional and high-performance structural materials, and elimination of technical and standards barriers to the introduction of new materials and technologies.

4. Improved active fire protection, including the design, performance, reliability, and redundancy of sprinklers, standpipes/hoses, fire alarms, and smoke management systems.
5. Improved building evacuation, including system designs that facilitate safe and rapid egress, methods for ensuring clear and timely emergency communications to occupants, better occupant preparedness for evacuation during emergencies, and incorporation of appropriate egress technologies.
6. Improved emergency response, including better access to the buildings and better operations, emergency communications, and command and control in large-scale emergencies.
7. Improved procedures and practices, including encouraging code compliance by nongovernmental and quasi-governmental entities, adoption and application of egress requirements in available code provisions for existing buildings, and retention and availability of building documents over the life of a building.
8. Education and training programs for fire protection engineers, structural engineers, architects, and building regulatory and fire service personnel.

Each recommendation has been assigned a number (1, 2, 3, etc.) for easy reference. *The numerical ordering does not reflect any priority.*

The three categories and their subdivisions (also included in Table 9–1) are:

- Responsible Community:
  - Professional practices
  - Provisions in standards, codes, and regulations
  - Adoption and enforcement of the provisions
  - Research and development or requiring further study
  - Education and training

- Affected Population of Buildings:
  - All tall buildings<sup>18</sup>; building owners and public officials will need to determine appropriate performance requirements for buildings that are at risk due to types of structural, fire safety, or egress systems used, location, use, historic/iconic status, nature of occupancy, etc.
  - Selected other buildings (buildings that are at risk due to types of systems used, location, use, historic/iconic status, nature of occupancy, etc.).
- Relation to the outcome on September 11, 2001:
  - If in place, could have changed the outcome on September 11, 2001
  - Would not have changed the outcome, yet is an important building and fire safety issue that was identified during the course of the Investigation

In its recommendations, NIST does *not* prescribe:

- Specific systems, materials, or technologies. NIST encourages competition among different systems, materials, and technologies *that can meet performance requirements*.
- Specific threshold levels. NIST believes that the responsibility for the establishment of threshold levels properly belongs in the public policy setting process, in which the standards and codes development process plays a key role.

Only a few of the recommendations call for new requirements in standards and codes. Most of the recommendations deal with improving an existing standard or code requirement, establishing a standard for an existing practice without one, establishing the technical basis for an existing requirement, making a current requirement risk-consistent, adopting or enforcing a current requirement, or establishing a performance-based alternative to a current prescriptive requirement.

### 9.2.1 Group 1. Increased Structural Integrity

**The standards for estimating the load effects of potential hazards (e.g., progressive collapse, wind) and the design of structural systems to mitigate the effects of those hazards should be improved to enhance structural integrity.**

**Recommendation 1. NIST recommends that: (1) progressive collapse be prevented in buildings through the development and nationwide adoption of consensus standards and code provisions, along with the tools and guidelines needed for their use in practice; and (2) a standard methodology be developed—supported by analytical design tools and practical design**

---

<sup>18</sup> NIST has found that the physiological impacts on emergency responders of climbing numerous (e.g., 20 or more) stories makes it difficult to conduct effective and timely firefighting and rescue operations in building emergencies without functioning elevators. Consideration and better knowledge of factors such as ladder height, physiological factors involving emergency responders and building occupants, use of working elevators, and installation and use of protected elevators could refine the currently used definition of tall buildings to include multiple threshold levels.

**guidance—to reliably predict the potential for complex failures in structural systems subjected to multiple hazards.**

- a. Progressive collapse<sup>19</sup> should be prevented in buildings. The primary structural systems should provide alternate paths for carrying loads in case certain components fail (e.g., transfer girders or columns). This is especially important in buildings where structural components (e.g., columns, girders) support unusually large floor areas.<sup>20</sup> Progressive collapse is addressed only in a very limited way in practice and by codes and standards. For example, the initiating event in design to prevent progressive collapse may be removal of one or two columns at the bottom of the structure. Initiating events at multiple locations within the structure, or involving other key components and subsystems, should be analyzed commensurate with the risks considered in the design. The effectiveness of mitigation approaches involving new system and subsystem design concepts should be evaluated with conventional approaches based on indirect design (continuity, strength, and ductility of connections), direct design (local hardening), and redundant (alternate) load paths. The capability to prevent progressive collapse due to abnormal loads should include: (i) comprehensive design rules and practice guides; (ii) evaluation criteria, methodology, and tools for assessing the vulnerability of structures to progressive collapse; (iii) performance-based criteria for abnormal loads and load combinations; (iv) analytical tools to predict potential collapse mechanisms; and (v) computer models and analysis procedures for use in routine design practice. The federal government should coordinate the existing programs that address this need: those in the Department of Defense; the General Services Administration; the Defense Threat Reduction Agency; and NIST. *Affected Standards*<sup>21</sup>: ASCE-7, AISC Specifications, and ACI 318. These standards and other relevant committees should draw on expertise from ASCE/SFPE 29 for issues concerning progressive collapse under fire conditions. *Model Building Codes*: The consensus standards should be adopted in model building codes (i.e., the *International Building Code* and NFPA 5000) by mandatory reference to, or incorporation of, the latest edition of the standard. State and local jurisdictions should adopt and enforce the improved model building codes and national standards based on all 30 WTC recommendations. The codes and standards may vary from the WTC recommendations, but satisfy their intent.
- b. A robust, integrated predictive capability should be developed, validated, and maintained to routinely assess the vulnerability of whole structures to the effects of credible hazards. This capability to evaluate the performance and reserve capacity of structures does not exist and is a significant cause for concern. This capability also would assist in investigations of building failure—as demonstrated by the analyses of the WTC building collapses carried out in this Investigation. The failure analysis capability should include all possible complex failure phenomena that may occur under multiple hazards (e.g., bomb blasts, fires, impacts, gas explosions, earthquakes, and hurricane winds), experimentally validated models, and robust tools for routine analysis to predict such failures and their consequences. This capability should be developed via a coordinated effort involving federal, private sector, and academic research organizations in close partnership with practicing engineers.

---

<sup>19</sup> *Progressive collapse* (or *disproportionate collapse*) occurs when an initial local failure spreads from structural element to structural element resulting in the collapse of an entire structure or a disproportionately large part of it.

<sup>20</sup> While the WTC towers eventually collapsed, they had the capacity to redistribute loads from impact and fire damaged structural components and subsystems to undamaged components and subsystems. However, the core columns in the WTC towers lacked sufficient redundant (alternate) paths for carrying gravity loads.

<sup>21</sup> A full listing of the affected standards, including the complete names of these standards, is provided in Table 9–2, which is located following the recommendations.



**Recommendation 2.** NIST recommends that nationally accepted performance standards be developed for: (1) conducting wind tunnel testing of prototype structures based on sound technical methods that result in repeatable and reproducible results among testing laboratories; and (2) estimating wind loads and their effects on tall buildings for use in design, based on wind tunnel testing data and directional wind speed data. Wind loads specified in current prescriptive codes may not be appropriate for the design of very tall buildings since they do not account for building-specific aerodynamic effects. Further, a review of wind load estimates for the WTC towers indicated differences by as much as 40 percent from wind tunnel studies conducted in 2002 by two independent commercial laboratories. Major sources of differences in estimation methods currently used in practice occur in the selection of design wind speeds and directionality, the nature of hurricane wind profiles, the estimation of “component” wind effects by integrating wind tunnel data with wind speed and direction information, and the estimation of “resultant” wind effects using load combination methods. Wind loads were a major factor in the design of the WTC tower structures and were relevant to evaluating the baseline capacity of the structures to withstand abnormal events such as major fires or impact damage. Yet, there is lack of consensus on how to evaluate and estimate winds and their load effects on buildings.

- a. Nationally accepted standards should be developed and implemented for conducting wind tunnel tests, estimating site-specific wind speed and directionality based on available data, and estimating wind loads associated with specified design probabilities from wind tunnel test results and directional wind speed data.
- b. Nationally accepted standards should be developed for estimating wind loads in the design of tall buildings. The development of performance standards for estimating wind loads should consider (1) appropriate load combinations and load factors, including performance criteria for static and dynamic behavior, based on both ultimate and serviceability limit states, and (2) validation of wind load provisions in prescriptive design standards for tall buildings, given the universally acknowledged use of wind-tunnel testing and associated performance criteria. Limitations to the use of prescriptive wind load provisions should be clearly identified in codes and standards.

The standards development work can begin immediately to address many of the above needs. The results of those efforts should be adopted in practice as soon as they become available. The research that will be required to address the remaining needs also should begin immediately and results should be made available for standards development and use in practice. *Affected National Standard: ASCE-7. Model Building Codes:* The standard should be adopted in model building codes by mandatory reference to, or incorporation of, the latest edition of the standard.

**Recommendation 3.** NIST recommends that an appropriate criterion be developed and implemented to enhance the performance of tall buildings by limiting how much they sway under lateral load design conditions (e.g., winds and earthquakes). The stability and safety of tall buildings depend upon, among other factors, the magnitude of building sway or deflection, which tends to increase with building height. Conventional strength-based design methods, such as those used in the design of the WTC towers, do not limit deflections. The deflection limit state criterion, which is proposed here is in addition to the stress limit and serviceability requirement; it should be adopted either to complement the safety provided by conventional strength-based design or independently as an alternate deflection-based approach to the design of tall buildings for life safety. The recommended deflection limit state criterion is independent of the criterion used to ensure occupant comfort, which is met in current practice by limiting accelerations (e.g., in the 15 to 20 milli-g range). Lateral deflections, which already are limited in the design of tall buildings to

control damage in earthquake-prone regions, should also be limited in non-seismic areas.<sup>22</sup> *Affected National Standards:* ASCE-7, AISC Specifications, and ACI 318. *Model Building Codes:* The standards should be adopted in model building codes by mandatory reference to, or incorporation of, the latest edition of the standard.

## 9.2.2 Group 2. Enhanced Fire Endurance of Structures

**The procedures and practices used to ensure the fire endurance of structures be enhanced by improving the technical basis for construction classifications and fire resistance ratings, improving the technical basis for standard fire resistance testing methods, use of the “structural frame” approach to fire resistance ratings, and developing in-service performance requirements and conformance criteria for sprayed fire-resistive materials.**

**Recommendation 4. NIST recommends evaluating, and where needed improving, the technical basis for determining appropriate construction classification and fire rating requirements (especially for tall buildings)—and making related code changes now as much as possible—by explicitly considering factors including:**<sup>23</sup>

- **timely access by emergency responders and full evacuation of occupants, or the time required for burnout without partial collapse;**
- **the extent to which redundancy in active fire protection (sprinkler and standpipe, fire alarm, and smoke management) systems should be credited for occupant life safety;**<sup>24</sup>
- **the need for redundancy in fire protection systems that are critical to structural integrity;**<sup>25</sup>
- **the ability of the structure and local floor systems to withstand a maximum credible fire scenario<sup>26</sup> without collapse, recognizing that sprinklers could be compromised, not operational, or non-existent;**
- **compartmentation requirements (e.g., 12,000 ft<sup>2</sup> (27)) to protect the structure, including fire rated doors and automatic enclosures, and limiting air supply (e.g., thermally resistant window assemblies) to retard fire spread in buildings with large, open floor plans;**

<sup>22</sup> Analysis of baseline performance under the original design wind loads indicated that the WTC towers would need to have been between 50 percent and 90 percent stiffer to achieve a typical drift ratio used in current practice for non-seismic regions, though not required by building codes. Limiting drift would have required increasing exterior column areas in lower stories and/or significant additional damping.

<sup>23</sup> The construction classification and fire rating requirements should be *risk-consistent* with respect to the *design-basis hazards* and the *consequences* of those hazards. The fire rating requirements, which were originally developed based on experience with buildings less than 20 stories in height, have generally decreased over the past 80 years since historical fire data for buildings suggests considerable conservatism in those requirements. For tall buildings, the likely consequences of a given threat to an occupant on the upper floors are more severe than the consequences to an occupant on the first floor or the lower floors. For example, with non-functioning elevators, both the time requirements are much greater for full building evacuation from upper floors and emergency responder access to those floors. It is not clear how the current height and areas tables in building codes consider the technical basis for the progressively increasing risk to an occupant on the upper floors of tall buildings that are much greater than 20 stories in height.

<sup>24</sup> Occupant life safety, prevention of fire spread, and structural integrity are considered separate safety objectives.

<sup>25</sup> The passive fire protection system (includes fireproofing insulation, compartmentation, and firestopping) and the active sprinkler system each provide redundancy for maintaining structural integrity in a building fire, should one of the systems fail to perform its intended function.

<sup>26</sup> A maximum credible fire scenario includes conditions that are severe, but reasonable to anticipate, conditions related to building construction, occupancy, fire loads, ignition sources, compartment geometry, fire control methods, etc., as well as adverse, but reasonable to anticipate operating conditions.

- **the effect of spaces containing unusually large fuel concentrations for the expected occupancy of the building; and**
- **the extent to which fire control systems, including suppression by automatic or manual means, should be credited as part of the prevention of fire spread.**

Adoption of this recommendation will allow building codes to distinguish the risks associated with different building heights, fuel concentrations, and fire protection systems. Research is needed to develop the data and evaluate alternative proposals for construction classifications and fire ratings. *Model Building Codes:* A comprehensive review of current construction classification and fire rating requirements and the establishment of a uniform set of revised thresholds with a firm technical basis that considers the factors identified above should be undertaken.<sup>28</sup>

**Recommendation 5. NIST recommends that the technical basis for the century-old standard for fire resistance testing of components, assemblies, and systems be improved through a national effort. Necessary guidance also should be developed for extrapolating the results of tested assemblies to prototypical building systems. A key step in fulfilling this recommendation is to establish a capability for studying and testing the components, assemblies, and systems under realistic fire and load conditions.**

This effort should address the technical issues listed below:<sup>29</sup>

- a. Criteria and test methods for determining:
  - structural limit states, including failure, and means for measurement;
  - effect of scale of test assembly versus prototype application, especially for long-span structures that significantly exceed the size of testing furnaces;
  - effect of restraining thermal expansion (end-restraint conditions) on test results, especially for long-span structures that have greater flexibility;
  - fire resistance of structural connections, especially the fire protection required for a loaded connection to achieve a specified rating;<sup>30</sup>
  - effect of the combination of loading and exposure (time-temperature profile) required to adequately represent expected conditions;
  - the repeatability and reproducibility of test results (typically results from a single test are used to determine rating for a component or assembly); and

<sup>27</sup> Or a more appropriate limit, which represents a reasonable area for active firefighting operations.

<sup>28</sup> The National Fire Protection Association (NFPA) 5000 model code and the International Building Code (IBC) both recognize the risks associated with different building heights and accepted changes in 2001 and 2004, respectively. Both model codes now require that buildings 420 feet and higher have a minimum 4 hour structural fire-resistance rating. The previous requirement was 2 hours. The change provides increased fire resistance for the structural system leading to enhanced tenability of the structure and gives firefighters additional protection while fighting a fire. While NIST supports these changes as an interim step, NIST believes that it is essential to complete a comprehensive review that will establish a firm technical basis for construction classification and fire rating requirements.

<sup>29</sup> The technical issues were identified from the series of four fire resistance tests of the WTC floor system and the review and analysis of relevant documents that were conducted as part of this Investigation.

<sup>30</sup> There is a lack of test data on the fire resistance ratings of loaded connections. The fire resistance of structural connections is not rated in current practice. Also, standards and codes do not provide guidance on fireproofing requirements for structural connections when the connected members have different fire resistance ratings.

- realistic ratings for structural assemblies made with materials that have improved elevated temperature properties (strength, modulus, creep behavior).
- b. Improved procedures and guidance to analyze and evaluate existing data from fire resistance tests of building components and assemblies for use in qualifying an untested building element.
- c. Relationships between prescriptive ratings and performance of the assembly in real fires.

*Affected National and International Standards*<sup>31</sup>: ASTM E 119, NFPA 251, UL 263, and ISO 834. *Model Building Codes*: The standards should be adopted in model building codes by mandatory reference to, or incorporation of, the latest edition of the standard.

**Recommendation 6.** NIST recommends the development of criteria, test methods, and standards: (1) for the in-service performance of sprayed fire-resistive materials (SFRM, also commonly referred to as fireproofing or insulation) used to protect structural components; and (2) to ensure that these materials, as-installed, conform to conditions in tests used to establish the fire resistance rating of components, assemblies, and systems. This should include:

- Improved criteria and testing methodology for the performance and durability of SFRM (e.g., adhesion, cohesion, abrasion and impact resistance) under in-service exposure conditions (e.g., temperature, humidity, vibration, impact, with/without primer paint on steel<sup>32</sup>) for use in acceptance and quality control. The current test method to measure the bond strength, for example, does not distinguish the cohesive strength from the tensile and shear adhesive strengths. Nor does it consider the effect of primer paint on the steel surface. Test requirements that explicitly consider the effects of abrasion, vibration, shock, and impact under normal service conditions are limited or do not exist. Also, the effects of elevated temperatures on thermal properties and bond strength are not considered in evaluating the performance and durability of SFRM.
- Inspection procedures, including measurement techniques and practical conformance criteria, for SFRM in both the building codes and fire codes for use after installation, renovation, or modification of all mechanical and electrical systems and by fire inspectors over the life of the building. Existing standards of practice (AIA MasterSpec and AWCI Standard 12), often required by codes for some buildings need to be broadly applied to both new and existing buildings. These standards may require improvements to address the issues identified in this recommendation.
- Criteria for determining the effective uniform SFRM thickness—thermally equivalent to the variable thickness of the product as it actually is applied—that can be used to ensure that the product in the field conforms to the near uniform thickness conditions in the tests used to establish the fire resistance rating of the component, assembly, or system. Such criteria are needed to ensure that the as-installed SFRM will provide the intended performance.

<sup>31</sup> While the WTC recommendations are focused mainly on U.S. national standards, each U.S. standard has counterpart international standards. In a recent report (ISO/TMB AGS N 46), the International Organization for Standardization (ISO), through its Advisory Group for Security (AGS), has recommended that since many of the ISO standards for the design of buildings date to the 1980s, they should be reviewed and updated to make use of the studies done by NIST on the World Trade Center disaster, the applicability of new technology for rescue from high buildings, natural disasters, etc. ISO's Technical Advisory Group 8 coordinates standards work for buildings.

<sup>32</sup> NIST tests showed that the adhesive strength of SFRM on steel coated with primer paint was a third to half of the adhesive strength on steel that had not been coated with primer paint. The SFRM products used in the WTC towers were applied to steel components coated with primer paint.

- Methods for predicting the effectiveness of SFRM insulation as a function of its properties, the application characteristics, and the duration and intensity of the fire.
- Methods for predicting service life performance of SFRM under in-service conditions.

*Affected Standards:* AIA MasterSpec and AWCI Standard 12 for field inspection and conformance criteria; ASTM standards for SFRM performance criteria and test methods. *Model Building Codes:* The standards should be adopted in model building codes by mandatory reference to, or incorporation of, the latest edition of the standard. (See Recommendation 10 for more on this issue.)

**Recommendation 7.** NIST recommends the adoption and use of the “structural frame” approach to fire resistance ratings. This approach requires that structural members—such as girders, beams, trusses and spandrels having direct connection to the columns, and bracing members designed to carry gravity loads—be fire protected to the same fire resistance rating as columns. This approach is currently required by the International Building Code (IBC), one of the model codes, and is in the process of adoption by NFPA 5000, the other model code. This requirement ensures consistency in the fire protection provided to all of the structural elements that contribute to overall structural stability.<sup>33</sup> State and local jurisdictions should adopt and enforce this requirement.

### 9.2.3 Group 3. New Methods for Fire Resistant Design of Structures

**The procedures and practices used in the fire resistant design of structures should be enhanced by requiring an objective that uncontrolled fires result in burnout without partial or global (total) collapse. Performance-based methods are an alternative to prescriptive design methods. This effort should include the development and evaluation of new fire-resistive coating materials and technologies and evaluation of the fire performance of conventional and high-performance structural materials.**

**Recommendation 8.** NIST recommends that the fire resistance of structures be enhanced by requiring a performance objective that uncontrolled building fires result in burnout without partial or global (total) collapse. Such a provision should recognize that sprinklers could be compromised, nonoperational, or nonexistent. Current methods for determining the fire resistance rating of structural assemblies do not explicitly specify a performance objective. The rating resulting from current test methods indicates that the assembly (component or subsystem) continued to support its superimposed load (simulating a maximum load condition) during the test exposure without collapse. *Model Building Codes:* This recommendation should be included into the national model codes as an objective and adopted as an integral part of fire resistance design for structures. The issue of non-operational sprinklers could be addressed using the existing concept of Design Scenario 8 of NFPA 5000, where such compromise is assumed and the result is required to be acceptable to the Authority Having Jurisdiction. *Affected Standards:* ASCE-7, AISC Specifications, ACI 318, and ASCE/SFPE 29.

**Recommendation 9.** NIST recommends the development of: (1) performance-based standards and code provisions, as an alternative to current prescriptive design methods, to enable the design and retrofit of structures to resist real building fire conditions, including their ability to achieve the performance objective of burnout without structural or local floor collapse; and (2) the tools, guidelines, and test methods necessary to evaluate the fire performance of the

<sup>33</sup> Had this requirement been adopted by the 1968 New York City building code, the WTC floor system, including its connections, would have had the 3 hour rating required for the columns since the floors braced the columns.

**structure as a whole system.** Standards development organizations, including the American Institute of Steel Construction, have already begun developing performance-based provisions to consider the effects of fire in structural design.

This performance-based capability should include the development of, but not be limited to:

- a. Standard methodology, supported by performance criteria, analytical design tools, and practical design guidance; related building standards and codes for fire resistance design and retrofit of structures, working through the consensus process for nationwide adoption; comprehensive design rules and guidelines; methodology for evaluating thermostructural performance of structures; and computational models and analysis procedures for use in routine design practice.
- b. Standard methodology for specifying multi-compartment, multi-floor fire scenarios for use in the design and analysis of structures to resist fires, accounting for building-specific conditions such as geometry, compartmentation, fuel load (e.g., building contents and any flammable fuels such as oil and gas), fire spread, and ventilation; and methodology for rating the fire resistance of structural systems and barriers under realistic design-basis fire scenarios.
- c. Publicly available computational software to predict the effects of fires in buildings—developed, validated, and maintained through a national effort—for use in the design of fire protection systems and the analysis of building response to fires. Improvements should include the fire behavior and contribution of real combustibles; the performance of openings, including door openings and window breakage, that controls the amount of oxygen available to support the growth and spread of fires and whether the fire is fuel-controlled or ventilation-controlled; the floor-to-floor flame spread; the temperature rise in both insulated and uninsulated structural members and fire barriers; and the structural response of components, subsystems, and the total building system due to the fire.
- d. Temperature-dependent thermal and mechanical property data for conventional and innovative construction materials
- e. New test methods, together with associated conformance assessment criteria, to support the performance-based methods for fire resistance design and retrofit of structures. The performance objective of burnout without collapse will require the development of standard fire exposures that differ from those currently used.

*Affected National and International Standards:* ASCE-7, AISC Specifications, ACI 318, and ASCE/SFPE 29 for fire resistance design and retrofit of structures; NFPA, SFPE, ASCE, and ISO TC92 SC4 for building-specific multi-compartment, multi-floor design basis fire scenarios; and ASTM, NFPA, UL, and ISO for new test methods. *Model Building Codes:* The performance standards should be adopted as an alternate method in model building codes by mandatory reference to, or incorporation of, the latest edition of the standard.

**Recommendation 10.** NIST recommends the development and evaluation of new fire-resistive coating materials, systems, and technologies with significantly enhanced performance and durability to provide protection following major events. This could include, for example, technologies with improved adhesion, double-layered materials, intumescent coatings, and more energy absorbing SFRMs.<sup>34</sup> Consideration should be given to pre-treatment of structural steel

---

<sup>34</sup> Other possibilities include encapsulation of SFRM by highly elastic energy absorbing membranes or commodity grade carbon fiber or other wraps. The membrane would remain intact under shock, vibration, and impact but may be compromised in a fire, yet allowing the SFRM to perform its thermal insulation function. The carbon wrap would remain intact under shock, vibration, and impact and, possibly, under fire conditions as well.

members with some type of mill-applied fire protection to minimize the uncertainties associated with field application and in-use damage. If such an approach was feasible, only connections and any fire protection damaged during construction and fit-out would need to be field-treated. *Affected Standards:* Technical barriers, if any, to the introduction of new structural fire resistance materials, systems, and technologies should be identified and eliminated in the AIA MasterSpec, AWCI Standard 12 and ASTM standards for field inspection, conformance criteria, and test methods. *Model Building Codes:* Technical barriers, if any, to the introduction of new structural fire resistance materials, systems, and technologies should be eliminated from the model building codes.

**Recommendation 11.** NIST recommends that the performance and suitability of advanced structural steel, reinforced and pre-stressed concrete, and other high-performance material systems be evaluated for use under conditions expected in building fires. This evaluation should consider both presently available and new types of steels, concrete, and high-performance materials to establish the properties (e.g., yield and ultimate strength, modulus, creep behavior, failure) that are important for fire resistance, establish needed test protocols and acceptance criteria for such materials and systems, compare the performance of newer systems to conventional systems, and the cost-effectiveness of alternate approaches. Technical and standards barriers to the introduction and use of such advanced steel, concrete, and other high-performance material systems should be identified and eliminated, or at least minimized, if they are found to exist. *Affected Standards:* AISC Specifications and ACI 318. Technical barriers, if any, to the introduction of these advanced systems should be eliminated in ASTM E 119, NFPA 251, UL 263, ISO 834. *Model Building Codes:* Technical barriers, if any, to the introduction of these advanced systems should be eliminated from the model building codes.

#### 9.2.4 Group 4. Improved Active Fire Protection

Active fire protection systems (i.e., sprinklers, standpipes/hoses, fire alarms, and smoke management systems) should be enhanced through improvements to design, performance, reliability, and redundancy of such systems.

**Recommendation 12.** NIST recommends that the performance and possibly the redundancy of active fire protection systems (sprinklers, standpipes/hoses, fire alarms, and smoke management systems) in buildings be enhanced to accommodate the greater risks associated with increasing building height and population, increased use of open spaces, high-risk building activities, fire department response limits, transient fuel loads, and higher threat profile. The performance attributes should deal realistically with the system design basis, reliability of automatic/manual operations, redundancy, and reduction of vulnerabilities due to single point failures. *Affected Standards:* NFPA 13, NFPA 14, NFPA 20, NFPA 72, NFPA 90A, NFPA 92A, NFPA 92B, and NFPA 101. *Model Building Codes:* The performance standards should be adopted in model building codes by mandatory reference to, or incorporation of, the latest edition of the standard.

**Recommendation 13.** NIST recommends that fire alarm and communications systems in buildings be developed to provide continuous, reliable, and accurate information on the status of life safety conditions at a level of detail sufficient to manage the evacuation process in building fire emergencies; all communication and control paths in buildings need to be designed and installed to have the same resistance to failure and increased survivability above that specified in present standards. This should include means to maintain communications with evacuating occupants that can both reassure them and redirect them if conditions change. Pre-installed fire warden telephone systems in buildings can serve a useful purpose and may be installed in buildings, and if so, they should be made available for use by emergency responders. All

communication and control paths in buildings need to be designed and installed to have the same resistance to failure and increased survivability above that specified in present standards. *Affected Standards:* NFPA 1, NFPA 72, and NFPA 101. *Model Building and Fire Codes:* The performance standards should be adopted in model building and fire codes by mandatory reference to, or incorporation of, the latest edition of the standard.

**Recommendation 14.** NIST recommends that control panels at fire/emergency command stations in buildings be adapted to accept and interpret a larger quantity of more reliable information from the active fire protection systems that provide tactical decision aids to fireground commanders, including water flow rates from pressure and flow measurement devices, and that standards for their performance be developed. *Affected Standards:* NFPA 1, NFPA 72, and NFPA 101. *Model Building and Fire Codes:* The performance standards should be adopted in model building and fire codes by mandatory reference to, or incorporation of, the latest edition of the standard.

**Recommendation 15.** NIST recommends that systems be developed and implemented for: (1) real-time off-site secure transmission of valuable information from fire alarm and other monitored building systems for use by emergency responders, at any location, to enhance situational awareness and response decisions and maintain safe and efficient operations;<sup>35</sup> and (2) preservation of that information either off-site or in a black box that will survive a fire or other building failure for purposes of subsequent investigations and analysis. Standards for the performance of such systems should be developed, and their use should be required. *Affected Standards:* NFPA 1, NFPA 72, and NFPA 101. *Model Building and Fire Codes:* The performance standards should be adopted in model building and fire codes by mandatory reference to, or incorporation of, the latest edition of the standard.

## 9.2.5 Group 5. Improved Building Evacuation

Building evacuation should be improved to include system designs that facilitate safe and rapid egress, methods for ensuring clear and timely emergency communications to occupants, better occupant preparedness regarding their roles and duties for evacuation during emergencies, and incorporation of appropriate egress technologies.<sup>36</sup>

**Recommendation 16.** NIST recommends that public agencies, non-profit organizations concerned with building and fire safety, and building owners and managers develop and carry out public education and training campaigns, jointly and on a nationwide scale, to improve building occupants' preparedness for evacuation in case of building emergencies. This effort

---

<sup>35</sup> The alarm systems in the WTC towers were only capable of determining and displaying: (a) areas that had at some time reached alarm point conditions; and (b) areas that had not. The quality and reliability of information available to emergency responders at the Fire Command Station was not sufficient to understand the fire conditions. The only information transmitted outside the building was the fact that the building had gone into alarm. Further, the fire alarm system in WTC 7, which was transmitted to a monitoring service, was on "test" the morning of September 11, 2001, because routine maintenance was being performed. Under test conditions (1) the system is typically disabled for the entire building, not just for the area where work is being performed, and (2) alarm signals typically do not show up on an operator console.

<sup>36</sup> This effort should include standards and guidelines for the development and evaluation of emergency evacuation plans, including best practices for both partial and full evacuation, and the development of contingency plans that account for expected conditions that may require adaptation, including the compromise of all or part of an egress path before or during evacuation, or conditions such as widespread power failure, earthquake, or security threat that restrict egress from the building. Evacuation planning should include the process from initial notification of the need to evacuate to the point the occupants arrive at a place where their safety is ensured. These standards and guidelines should be suitable for assessing the adequacy of evacuation plans submitted for approval and should require occupant training through the conduct of regular drills.



should include better training and self-preparation of occupants, an effectively implemented system of floor wardens and building safety personnel, and needed improvements to standards. Occupant preparedness should include:

- a. Improved training and drills for building occupants to ensure that they know evacuation procedures for a variety of emergency scenarios (e.g., including evacuation and shelter in place), are familiar with the egress route, and are sufficiently aware of what is necessary if evacuation is required with minimal notice (e.g., footwear consistent with the distance to be traveled, a flashlight/glow stick for pathway illumination, and dust masks).
- b. Building owners and managers should educate tenants on the life safety systems present in their building(s), provide training materials explaining egress routes and stairwell and elevator information, and develop educational programs explaining the most appropriate responses in emergency situations. It is further recommended that the owners and managers of office buildings implement the necessary systems for collecting and storing the training history of each building occupant.
- c. Improved training and drills that routinely inform building occupants that roof rescue is not (or is) presently feasible as a standard evacuation option, that they should evacuate down the stairs in any full-building evacuation unless explicitly instructed otherwise by on-site incident commanders, and that elevators can be used if they are still in service and haven't been recalled or stopped.
- d. Improved codes, laws, and regulations that do not restrict or impede building occupants during evacuation drills from familiarizing themselves with the detailed layout of alternate egress routes for a full building evacuation.<sup>37</sup>

*Affected Standard:* ICC/ANSI A117-1. *Model Building and Fire Codes:* The standard should be adopted in model building and fire codes by mandatory reference to, or incorporation of, the latest edition of the standard. *Affected Organizations:* NFPA, NIBS, NCSBCS, BOMA, and CTBUH.

**Recommendation 17.** NIST recommends that tall buildings be designed to accommodate timely full building evacuation of occupants when required in building-specific or large-scale emergencies such as widespread power outages, major earthquakes, tornadoes, hurricanes without sufficient advanced warning, fires, explosions, and terrorist attack. Building size, population, function, and iconic status should be taken into account in designing the egress system. Stairwell capacity and stair discharge door width<sup>38</sup> should be adequate to accommodate counterflow due to emergency access by responders.

- a. Improved egress analysis models, design methodology, and supporting data should be developed to achieve a target evacuation performance (e.g., time for full building evacuation<sup>39</sup>) for the design building population by considering the building and egress system designs and human factors such as occupant size, mobility status, stairwell tenability conditions, visibility, and congestion.

<sup>37</sup> New York City Local Law 5 prohibits *requiring* occupants to practice stairwell evacuation during drills.

<sup>38</sup> Egress capacity should be based on an all-hazards approach that considers the number and width of stairs (and doors) as well as the possible use of scissor stairs credited as a single stair.

<sup>39</sup> Use of egress models is required to estimate the egress capacity for a range of different evacuation strategies, including full building evacuation. NIST found that the average surviving occupant in the WTC towers descended stairwells at about half the slowest speed previously measured for non-emergency evacuations.

- b. To the degree possible, mobility-impaired occupants should be provided a means for self-evacuation in the event of a building emergency. Current strategies (and law) generally require the mobility impaired to shelter-in-place and await assistance. New procedures, which provide redundancy in the event that the floor warden system or co-worker assistance fails, should consider full building evacuation, and may include use of fire-protected and structurally hardened elevators,<sup>40</sup> motorized evacuation technology, and/or dedicated communication technologies for the mobility impaired.
- c. If protected/hardened elevators are provided for emergency responders but become unusable during an emergency, due to a malfunction or a conventional threat whose magnitude exceeds the magnitude considered in design, sufficient stairwell capacity should be provided to ensure timely emergency responder access to buildings that are undergoing full evacuation. Such capacity could be provided either via dedicated stairways for fire service use or by building sufficient stairway capacity (i.e., number and width of stairways and/or use of scissor stairs credited as a single stair) to accommodate the evacuation of building occupants while allowing access to emergency responders with minimal hindrance from occupant counterflow.
- d. The egress allowance in assembly use spaces should be limited in state and local laws and regulations to no more than a doubling of the stairway capacity for the provision of a horizontal exit on a floor, as is the case now in the national model codes.<sup>41</sup> The use of a horizontal exit creates an area of refuge with a 2 hour fire rated separation, at least one stair on each side, and sufficient space for the expected occupant load.

*Affected Standards:* NFPA 101, ASME A 17. *Model Building and Fire Codes:* The standards should be adopted in model building and fire codes by mandatory reference to, or incorporation of, the latest edition of the standard.

**Recommendation 18.** NIST recommends that egress systems be designed: (1) to maximize remoteness of egress components (i.e., stairs, elevators, exits) without negatively impacting the average travel distance; (2) to maintain their functional integrity and survivability under foreseeable building-specific or large-scale emergencies; and (3) with consistent layouts, standard signage, and guidance so that systems become intuitive and obvious to building occupants during evacuations.

- a. Within a safety-based design hierarchy that should be developed, highest priority should be assigned to maintain the functional integrity, survivability, and remoteness of egress components and active fire protection systems (sprinklers, standpipes, associated water supply, fire alarms, and smoke management systems). The design hierarchy should consider the many systems (e.g., stairs, elevators, active fire protection, mechanical, electrical, plumbing, and structural) and system components, as well as functional integrity, tenant access, emergency responder access, building configuration, security, and structural design.

---

<sup>40</sup> Elevators should be explicitly designed to provide protection against large, but conventional, building fires. *Fire-protected* elevators also should be *structurally hardened* to withstand the range of foreseeable building-specific or large-scale emergencies. While progress has been made in developing the requirements and technologies for fire-protected elevators, similar criteria and designs for structurally hardened elevators remain to be developed.

<sup>41</sup> The New York City Building Code permits a *doubling* of allowed stair capacity when one area of refuge is provided on a floor and a *tripling* of stair capacity for two or more areas of refuge on a floor. In the world of post-September 11, 2001, it is difficult to predict (1) if, and for how long, occupants will be willing to wait in a refuge area before entering an egress stairway, and (2) what the impact would be of such a large group of people moving down the stairs on the orderly evacuation of lower floors.

- b. The design, functional integrity, and survivability of the egress and other life safety systems (e.g., stairwell and elevator shafts and active fire protection systems) should be enhanced by considering accidental structural loads such as those induced by overpressures (e.g., gas explosions), impacts, or major hurricanes and earthquakes, in addition to fire separation requirements. In selected buildings, structural loads due to other risks such as those due to terrorism may need to be considered. While NIST does not believe that buildings should be designed for aircraft impact, as the last line of defense for life safety, the stairwells and elevator shafts individually, or the core if these egress components are contained within the core, should have adequate structural integrity to withstand accidental structural loads and anticipated risks.
- c. Stairwell remoteness requirements should be met by a physical separation of the stairwells that provide a barrier to both fire and accidental structural loads. Maximizing stairwell remoteness, without negatively impacting the average travel distance, would allow a stairwell to maintain its structural integrity independent of any other stairwell that is subject to accidental loads, even if the stairwells are located within the same structural barrier such as the core. The current “walking path” measurement allows stairwells to be physically next to each other, separated only by a fire barrier. Reducing the clustering of stairways that also contain standpipe water systems provide the fire service with increased options for formulating firefighting strategies. This should not preclude the use of scissor stairs<sup>42</sup> as a means of increasing stair capacity—provided the scissor stair is only credited as a single stair.
- d. Egress systems should have consistent layouts with standard signage and guidance so that the systems become intuitive and obvious to all building occupants, including visitors, during evacuations. Particular consideration should be given to unexpected deviations in the stairwells (e.g., floors with transfer hallways).

*Affected Standard:* NFPA 101. *Model Building and Fire Codes:* The standard should be adopted in model building and fire codes by mandatory reference to, or incorporation of, the latest edition of the standard.

**Recommendation 19. NIST recommends that building owners, managers, and emergency responders develop a joint plan and take steps to ensure that accurate emergency information is communicated in a timely manner to enhance the situational awareness of building occupants and emergency responders affected by an event. This should be accomplished through better coordination of information among different emergency responder groups, efficient sharing of that information among building occupants and emergency responders, more robust design of emergency public address systems, improved emergency responder communication systems, and use of the Emergency Broadcast System (now known as the Integrated Public Alert and Warning System) and Community Emergency Alert Networks.**

- a. Situational awareness of building occupants and emergency responders in the form of information and event knowledge should be improved through better coordination of such information among emergency responder groups (9-1-1 dispatch, fire department or police department dispatch, emergency management dispatch, site security, and appropriate federal agencies), efficient sharing and communication of information between building occupants and emergency responders, and improved emergency responder communication systems (i.e., including effective communication within steel and reinforced concrete buildings, capacity commensurate with the scale of operations, and interoperability among different communication systems).

---

<sup>42</sup> Two separate stairways within the same enclosure and separated by a fire rated partition.

- b. The emergency communications systems in buildings should be designed with sufficient robustness and redundancy to continue providing public address announcements or instructions in foreseeable building-specific or large-scale emergencies, including widespread power outage, major earthquakes, tornadoes, hurricanes, fires, and accidental explosions. Consideration should be given to placement of building announcement speakers in stairways in addition to other standard locations.
- c. The Integrated Public Alert and Warning System (IPAWS) should be activated and used, especially during large-scale emergencies, as a means to rapidly and widely communicate information to building occupants and emergency responders to enhance their situational awareness and assist with evacuation.
- d. Local jurisdictions (cities and counties or boroughs) should seriously consider establishing a Community Emergency Alert Network (CEAN), within the framework of IPAWS, and make it available to the citizens and emergency responders of their jurisdiction to enhance situational awareness in emergencies.<sup>43</sup> The network should deliver important emergency alerts, information and real-time updates to all electronic communications systems or devices registered with the CEAN. These devices may include e-mail accounts, cell phones, text pagers, satellite phones, and wireless PDAs.

*Affected Standard:* NFPA 101 and/or a new standard. *Model Building and Fire Codes:* The standard should be adopted in model building and fire codes by mandatory reference to, or incorporation of, the latest edition of the standard to the extent it is within the scope of building and fire codes.

**Recommendation 20.** NIST recommends that the full range of current and next generation evacuation technologies should be evaluated for future use, including protected/hardened elevators, exterior escape devices, and stairwell descent devices, which may allow all occupants an equal opportunity for evacuation and facilitate emergency response access. *Affected Standards:* NFPA 101, ASME A 17, ASTM E 06, ANSI A117.1. *Model Building and Fire Codes:* The standards should be adopted in model building and fire codes by mandatory reference to, or incorporation of, the latest edition of the standard.

### 9.2.6 Group 6. Improved Emergency Response

**Technologies and procedures for emergency response should be improved to enable better access to buildings, response operations, emergency communications, and command and control in large-scale emergencies.**

**Recommendation 21.** NIST recommends the installation of fire-protected and structurally hardened elevators to improve emergency response activities in tall buildings by providing timely emergency access to responders and allowing evacuation of mobility-impaired building occupants. Such elevators should be installed for exclusive use by emergency responders during emergencies.<sup>44</sup> In tall buildings, consideration also should be given to installing such elevators for

---

<sup>43</sup> Types of emergency communications could include life safety information, severe weather warnings, disaster notifications (including information on terrorist attacks), directions for self-protection, locations of nearest available shelters, precautionary evacuation information, identification of available evacuation routes, and accidents or obstructions associated with roadways and utilities.

<sup>44</sup> The access time for emergency responders, in tall building emergencies where elevators are not functioning and only stairways can be used, averages between 1 min and 2 min per floor, which, for example, corresponds to between 1 1/2 hour and 2 hours (depending on the amount of gear and equipment carried) to reach the 60<sup>th</sup> floor of a tall building. Further, the physiological

use by all occupants. NIST has found that the physiological impacts on emergency responders of climbing numerous (e.g., 20 or more) stories makes it difficult to conduct effective and timely firefighting and rescue operations in building emergencies without functioning elevators. The use of elevators for these purposes will require additional operating procedures and protocols, as well as a requirement for release of elevator door restrictors by emergency response personnel.

*Affected Standards:* ASME A 17, ANSI 117.1, NFPA 70, NFPA 101, NFPA 1221, NFPA 1500, NFPA 1561, NFPA 1620, and NFPA 1710. *Model Building and Fire Codes:* The standards should be adopted in model building and fire codes by mandatory reference to, or incorporation of, the latest edition of the standard.

**Recommendation 22.** NIST recommends the installation, inspection, and testing of emergency communications systems, radio communications, and associated operating protocols to ensure that the systems and protocols: (1) are effective for large-scale emergencies in buildings with challenging radio frequency propagation environments; and (2) can be used to identify, locate, and track emergency responders within indoor building environments and in the field. The federal government should coordinate its efforts that address this need within the framework provided by the SAFECOM program of the Department of Homeland Security.

- a. Rigorous procedures, including pre-emergency inspection and testing, should be developed and implemented for ensuring the operation of emergency communications systems and radio communications in tall buildings and other large structures (including tunnels and subways), or at locations where communications are difficult.
- b. Performance requirements should be developed for emergency communications systems and radio communications that are used within buildings or in built-up urban environments, including standards for design, testing, certification, maintenance, and inspection of such systems.
- c. An interoperable architecture for emergency communications networks—and associated operating protocols—should be developed for unit operations within and across agencies in large-scale emergencies. The overall network architecture should cover local networking at incident sites, dispatching, and area-wide networks, considering: (a) the scale of needed communications in terms of the number of emergency responders using the system in a large-scale emergency and the organizational hierarchy; (b) challenges associated with radio frequency propagation especially in buildings; (c) interoperability with existing legacy emergency communications systems (i.e., between conventional two-way systems and newer wireless network systems); and (d) the need to identify, locate, and track emergency responders at an incident site.

*Affected Standards:* FCC, SAFECOM, NFPA Standards on Electronic Safety Equipment, NFPA 70, NFPA 297, and NFPA 1221. *Model Building Codes:* The standards should be adopted in model building codes by mandatory reference to, or incorporation of, the latest edition of the standard.

**Recommendation 23.** NIST recommends the establishment and implementation of detailed procedures and methods for gathering, processing, and delivering critical information through integration of relevant voice, video, graphical, and written data to enhance the situational awareness of all emergency responders. An information intelligence sector<sup>45</sup> should be established to coordinate the effort for each incident. *Affected Standards:* National Incident

---

impact on the emergency responders of climbing more than 10 to 12 floors in a tall building makes it difficult for them to immediately begin aggressive firefighting and rescue operations.

<sup>45</sup> A group of individuals that is knowledgeable, experienced, and specifically trained in gathering, processing, and delivering information critical for emergency response operations and is ready for activation in large and/or dangerous events.

Management System (NIMS), NRP, SAFECOM, FCC, NFPA Standards on Electronic Safety Equipment, NFPA 1500, NFPA 1561, NFPA 1620, NFPA 1710, and NFPA 1221. *Model Building Codes*: The standards should be adopted in model building codes by mandatory reference to, or incorporation of, the latest edition of the standard.

**Recommendation 24. NIST recommends the establishment and implementation of codes and protocols for ensuring effective and uninterrupted operation of the command and control system for large-scale building emergencies.**

- a. State, local, and federal jurisdictions should implement NIMS. The jurisdictions should work with the Department of Homeland Security to review, test, evaluate, and implement an effective unified command and control system. NIMS addresses interagency coordination and establishes a response matrix—assigning lead agency responsibilities for different types of emergencies and functions. At a minimum, each supporting agency should assign an individual to provide coordination with the lead agency at each incident command post.
- b. State, local, and federal emergency operations centers (EOCs) should be located, designed, built, and operated with security and operational integrity as a key consideration.
- c. Command posts should be established outside the potential collapse footprint of any building which shows evidence of large multi-floor fires or has serious structural damage. A continual assessment of building stability and safety should be made in such emergencies to guide ongoing operations and enhance emergency responder safety. The information necessary to make these assessments should be made available to those assigned responsibility (see related Recommendations 15 and 23).
- d. An effective command system should be established and operating before a large number of emergency responders and apparatus are dispatched and deployed. Through training and drills, emergency responders and ambulances should be required to await dispatch requests from the incident command system and not to self-dispatch in large-scale emergencies.
- e. Actions should be taken via training and drills to ensure a coordinated and effective emergency response at all levels of the incident command chain by requiring all emergency responders that are given an assignment to immediately adopt and execute the assignment objectives.
- f. Command post information and incident operations data should be managed and broadcast to command and control centers at remote locations so that information is secure and accessible by all personnel needing the information. Methods should be developed and implemented so that any information that is available at an interior information center is transmitted to a emergency responder vehicle or command post outside the building.

*Affected Standards*: NIMS, NRP, SAFECOM, FCC, NFPA Standards on Electronic Safety Equipment, NFPA 1221, NFPA 1500, NFPA 1561, NFPA 1620, and NFPA 1710. *Model Building Codes*: The standards should be adopted in model building codes by mandatory reference to, or incorporation of, the latest edition of the standard.

### 9.2.7 Group 7. Improved Procedures and Practices

**The procedures and practices used in the design, construction, maintenance, and operation of buildings should be improved to include encouraging code compliance by nongovernmental and quasi-governmental entities, adoption and application of egress and sprinkler requirements in codes for existing buildings, and retention and availability of building documents over the life of a building.**

**Recommendation 25.** Nongovernmental and quasi-governmental entities that own or lease buildings and are not subject to building and fire safety code requirements of any governmental jurisdiction are nevertheless concerned about the safety of the building occupants and the responding emergency personnel. NIST recommends that such entities be encouraged to provide a level of safety that equals or exceeds the level of safety that would be provided by strict compliance with the code requirements of an appropriate governmental jurisdiction. To gain broad public confidence in the safety of such buildings, NIST further recommends that as-designed and as-built safety be certified by a qualified third party, independent of the building owner(s). The process should not use self-approval for code enforcement in areas including interpretation of code provisions, design approval, product acceptance, certification of the final construction, and post-occupancy inspections over the life of the buildings.<sup>46</sup>

**Recommendation 26.** NIST recommends that state and local jurisdictions adopt and aggressively enforce available provisions in building codes to ensure that egress and sprinkler requirements are met by existing buildings.<sup>47</sup> Further, occupancy requirements should be modified where needed (such as when there are assembly use spaces within an office building) to meet the requirements in model building codes. Provisions related to egress and sprinkler requirements in existing buildings are available in such codes as the *International Existing Building Code (IEBC)*, *International Fire Code*, NFPA 1, NFPA 101, and ASME A 17.3. For example, the IEBC defines three levels of building alteration (removal and replacement or covering of existing materials and equipment, reconfiguration of space or system or installation of new equipment, and work area in excess of 50 percent of the aggregate area of the building). At the lowest level there are no upgrade implications for sprinklers and the egress system. At the next level, sprinklers are required in work areas serving greater than 30 persons if certain other conditions related to building height and use such as shared exists also are met. There are numerous requirements for means of egress, including number of exits, specification of doors, dead-end corridors and travel distances, lighting, signage, and handrails. At the highest level, the sprinkler and egress requirements are identical to the second level without the minimum 30 person restriction and the other conditions related to building height and use. The Life Safety Code (NFPA 101) applies retroactively to all buildings, independent of whether any work is currently being done on the building, and ASME 17.3 applies retroactively to all elevators as a minimum set of requirements.

**Recommendation 27.** NIST recommends that building codes incorporate a provision that requires building owners to retain documents, including supporting calculations and test data, related to building design, construction, maintenance and modifications over the entire life of

<sup>46</sup> The long-standing stated policy of The Port Authority of New York and New Jersey (PANYNJ) was to meet and, where appropriate, exceed the requirements of local building and fire codes, and it entered into agreements with the New York City Department of Buildings and The Fire Department of the City of New York in accordance with that policy. Although the PANYNJ sought review and concurrence from New York City in the areas listed in the recommendation, the PANYNJ was not required to yield, and appears not to have yielded, approval authority to New York City. The PANYNJ was created as an interstate entity, a “body corporate and politic,” under its charter, pursuant to Article 1, Section 10 of the U.S. Constitution permitting compacts between states. Further, there are many other similar nongovernmental and quasi-governmental entities in the United States. A comprehensive review of documents conducted as part of this Investigation suggests that the WTC towers generally were designed and maintained consistent with the requirements of the 1968 New York City Building Code. Areas of concern included fireproofing of WTC floor system, height of tenant separation walls, and egress requirements for the assembly use space for the Windows of the World in WTC 1 and Top of the World observation deck in WTC 2. These areas of concern did not play a significant role in determining the outcomes related to the events of September 11, 2001.

<sup>47</sup> The WTC towers were unsprinklered when built. It took nearly 28 years after passage of New York City Local Law 5 in 1973, which required either compartmentation or sprinklering, for the buildings to be fully sprinklered (the Port Authority chose not to use the compartmentation option in Local Law 5). This was about 13 years more than the 15-year period for full compliance with Local Law 5 that was set by Local Law 84 of 1979.

**the building.**<sup>48</sup> Means should be developed for offsite storage and maintenance of the documents. In addition, NIST recommends that relevant building information be made available in suitably designed hard copy or electronic format for use by emergency responders. Such information should be easily accessible by responders during emergencies. *Model Building Codes:* Model building codes should incorporate this recommendation. State and local jurisdictions should adopt and enforce these requirements.

**Recommendation 28.** NIST recommends that the role of the “Design Professional in Responsible Charge”<sup>49</sup> be clarified to ensure that: (1) all appropriate design professionals (including, e.g., the fire protection engineer) are part of the design team providing the standard of care when designing buildings employing innovative or unusual fire safety systems,<sup>50</sup> and (2) all appropriate design professionals (including, e.g., the structural engineer and the fire protection engineer) are part of the design team providing the standard of care when designing the structure to resist fires, in buildings that employ innovative or unusual structural and fire safety systems. *Affected Standards:* AIA Practice Guidelines. *Model Building Codes:* The IBC, which already defines the “Design Professional in Responsible Charge,” be clarified to address this recommendation. The NFPA 5000 should incorporate the “Design Professional in Responsible Charge” concept and address this recommendation.

### 9.2.8 Group 8. Education and Training

The professional skills of building and fire safety professionals should be upgraded through a national education and training effort for fire protection engineers, structural engineers, and architects. The skills of the building regulatory and fire service personnel should also be upgraded to provide sufficient understanding and the necessary skills to conduct the review, inspection, and approval tasks for which they are responsible.

**Recommendation 29.** NIST recommends that continuing education curricula be developed and programs be implemented for (1) training fire protection engineers and architects in structural engineering principles and design, and (2) training structural engineers, architects, fire protection engineers, and code enforcement officials in modern fire protection principles and technologies, including fire-resistance design of structures, and (3) training building regulatory and fire service personnel to upgrade their understanding and skills to conduct the review, inspection, and approval tasks for which they are responsible. The outcome would further the integration of the disciplines in effective fire-safe design of buildings. *Affected Organizations:* AIA, SFPE, ASCE, ASME, AISC, ACI, and state licensing boards. *Model Building Codes:* Detailed criteria and requirements should be incorporated into the model building codes under the topic “Design Professional in Responsible Charge.”

<sup>48</sup> The availability of inexpensive electronic storage media and tools for creating large searchable databases make this feasible.

<sup>49</sup> In projects involving a design team, the “Design Professional in Responsible Charge”—usually the lead architect—ensures that the team members use consistent design data and assumptions, coordinates overlapping specifications, and serves as the liaison to the enforcement and reviewing officials and to the owner. The term is defined in the International Building Code and in the ICC Performance Code for Buildings and Facilities (where it is the Principal Design Professional).

<sup>50</sup> If the fire safety concepts in tall buildings had been sufficiently mature in the 1960s, it is possible that the risks associated with jet-fuel ignited multi-floor fires might have been recognized and taken into account when the impact of a Boeing 707 aircraft was considered by the structural engineer during the design of the WTC towers.



**Recommendation 30.** NIST recommends that academic, professional short-course, and web-based training materials in the use of computational fire dynamics and thermostructural analysis tools be developed and delivered to strengthen the base of available technical capabilities and human resources. *Affected Organizations:* AIA, SFPE, ASCE, ASME, AISC, and ACI, ICC, NFPA.

### 9.3 NEXT STEPS

After issuance of the final report, the National Construction Safety Team Act requires NIST to:

- Conduct, or enable or encourage the conducting of, appropriate research recommended by the Team;
- Promote (consistent with existing procedures for the establishment of building standards, codes, and practices) the appropriate adoption by the Federal Government, and encourage the appropriate adoption by other agencies and organizations, of the recommendations of the Team with respect to—
  - Technical aspects of evacuation and emergency response procedures;
  - Specific improvements to building standards, codes, and practices; and
  - Other actions needed to help prevent future building failures.

NIST is assigning top priority to work vigorously with the building and fire safety communities to assure that there is a complete understanding of the recommendations and to provide needed technical assistance in getting them implemented. NIST has identified specific codes, standards, and practices affected by each of the recommendations (Tables 9-2a, 9-2b, and 9-2c) and already begun to reach out to the responsible organizations to pave the way for a timely, expedited consideration of the recommendations. Toward this end, NIST held a conference September 13–15, 2005, that was attended by over 200 people, including all of the major standards and codes development organizations.

NIST also has awarded a contract to the National Institute of Building Sciences (NIBS) to convene a panel of building code experts to turn appropriate recommendations into code language suitable for submission of code change proposals to the two national model code developers.

In addition, NIST will implement a web-based system so that the public can track progress on implementing the recommendations. The web site will list each of the recommendations, the specific organization or organizations (e.g., standards and code developers, professional groups, state and local authorities) responsible for its implementation, the status of its implementation by organization, and the plans or work in progress to implement the recommendations.

**Table 9-1. Crosswalk of Recommendations to Categories.**

Recommendation Area	Recommendation Group	Recommendation Number	Responsible Community					Application		Relation to 9/11 Outcome	
			Practices	Codes, Regulations	Standards, Adoption & Enforcement	R&D/Further Study	Education & Training	All Tall Buildings	Selected Other Buildings	Related	Unrelated
Increased Structural Integrity	1	1	✓	✓	✓	✓	✓	✓	✓		
		2	✓	✓		✓	✓	✓		✓	
		3	✓	✓		✓	✓			✓	
Enhanced Fire Endurance of Structures	2	4	✓	✓		✓		✓		✓	
		5		✓		✓	✓		✓		
		6	✓	✓	✓	✓	✓			✓	
		7		✓	✓		✓	✓		✓	
New Methods for Fire Resistant Design of Structures	3	8	✓	✓	✓	✓	✓	✓	✓		
		9	✓	✓		✓	✓	✓		✓	
		10	✓	✓		✓		✓	✓		
		11	✓			✓		✓	✓	✓	
Improved Active Fire Protection	4	12	✓	✓		✓		✓	✓		
		13		✓		✓		✓	✓		
		14		✓		✓		✓	✓		
		15	✓	✓		✓		✓	✓	✓	
Improved Building Evacuation	5	16	✓	✓		✓	✓	✓	✓	✓	
		17	✓	✓		✓	✓	✓	✓	✓	
		18	✓	✓				✓		✓	
		19	✓	✓			✓	✓	✓	✓	
		20	✓	✓		✓		✓	✓	✓	

Recommendation Area	Recommendation Group	Recommendation Number	Responsible Community					Application		Relation to 9/11 Outcome	
			Practices	Standards, Codes, Regulations	Adoption & Enforcement	R&D/Further Study	Education & Training	All Tall Buildings	Selected Other Buildings	Related	Unrelated
Improved Emergency Response	6	21	✓	✓		✓		✓		✓	
		22	✓	✓	✓	✓	✓	✓	✓	✓	
		23	✓	✓	✓	✓	✓	✓	✓	✓	
		24	✓	✓	✓	✓	✓	✓	✓	✓	
Improved Procedures and Practices	7	25	✓	✓	✓			✓	✓		✓
		26	✓		✓			✓	✓		✓
		27	✓	✓	✓			✓	✓	✓	
		28	✓	✓			✓	✓	✓	✓	
Education and Training	8	29	✓	✓			✓	✓	✓	✓	
		30	✓				✓	✓	✓		✓

**Table 9–2a. Standards Affected by the Recommendations.**

<b>Affected Standard</b>	<b>Group Number</b>	<b>Recommendation</b>
American Concrete Institute, ACI 318 - Building Code Requirements for Structural Concrete	1. Increased Structural Integrity 3. New Methods for Fire Resistant Design of Structures	1, 3, 8, 9, 11
American Institute of Architects, AIA MASTERSPEC – Master Specification System for Design Professionals and the Building/Construction Industry	2. Enhanced Fire Endurance of Structures 3. New Methods for Fire Resistant Design of Structures	6, 10
American Institute of Architects Practice Guidelines	7. Improved Procedures and Practices	28
American Institute of Steel Construction Specification for Structural Steel Buildings	1. Increased Structural Integrity 3. New Methods for Fire Resistant Design of Structures	1, 3, 8, 9, 11
American Society of Civil Engineers, ASCE 7 – Minimum Design Loads for Buildings and Other Structures	1. Increased Structural Integrity 3. New Methods for Fire Resistant Design of Structures	1, 2, 3, 8, 9
American Society of Civil Engineers, ASCE 29 – Standard Calculation Methods for Structural Fire Protection	1. Increased Structural Integrity 3. New Methods for Fire Resistant Design of Structures	1, 8, 9
American Society of Mechanical Engineers, ASME A 17 – Elevators and Escalators, and A 17.1 – Safety Code for Elevators and Escalators	5. Improved Building Evacuation 6. Improved Emergency Response	17, 20, 21
American Society of Mechanical Engineers, ASME A 17.3 – Safety Code for Existing Elevators and Escalators	7. Improved Procedures and Practices	26
Association of the Wall and Ceiling Industry AWCI 12 – Design Selection Utilizing Sprayed Fire-Resistive Materials AWCI 12-A – Standard Practice for the Testing and Inspection of Field Applied Fire-Resistive Materials AWCI 12-B – Standard Practice for the Testing and Inspection of Field Applied Intumescent Fire-Resistive Materials	2. Enhanced Fire Endurance of Structures 3. New Methods for Fire Resistant Design of Structures	6, 10
ASTM International Committee E 06, Performance of Buildings; Subcommittee E 06.77, High-Rise Building External Evacuation Devices	5. Improved Building Evacuation	20
ASTM International, ASTM E 119 – Standard Test Methods for Fire Tests of Building Construction and Materials	2. Enhanced Fire Endurance of Structures 3. New Methods for Fire Resistant Design of Structures	5, 11
Department of Homeland Security, National Incident Management System (NIMS)	6. Improved Emergency Response	23, 24

Affected Standard	Group Number	Recommendation
Department of Homeland Security, National Response Plan (NRP)	6. Improved Emergency Response	23, 24
Department of Homeland Security, SAFECOM	6. Improved Emergency Response	22, 23, 24
Federal Communications Commission, Emergency Responder Radio Communications Regulations	6. Improved Emergency Response	22, 23, 24
International Code Commission/American National Standards Institute, ICC/ANSI A117.1 – Accessible and Usable Buildings and Facilities	5. Improved Building Evacuation 6. Improved Emergency Response	16, 20, 21
International Organization for Standardization, ISO 834 – Fire Resistance Tests	2. Enhanced Fire Endurance of Structures 3. New Methods for Fire Resistant Design of Structures	5, 11
National Fire Protection Association, NFPA 1 – Fire Prevention Code	4. Enhanced Active Fire Protection 7. Improved Procedures and Practices	12, 13, 14, 15, 26
National Fire Protection Association, NFPA 13 – Installation of Sprinkler Systems	4. Enhanced Active Fire Protection	12
National Fire Protection Association, NFPA 14 – Installation of Standpipe and Hose Systems	4. Enhanced Active Fire Protection	12
National Fire Protection Association, NFPA 20 – Installation of Stationary Pumps for Fire Protection	4. Enhanced Active Fire Protection	12
National Fire Protection Association, NFPA 70 – National Electrical Code	6. Improved Emergency Response	21, 22
National Fire Protection Association, NFPA 72 – National Fire Alarm Code	4. Enhanced Active Fire Protection	12, 13, 14, 15
National Fire Protection Association, NFPA 90A – Standard for Installation of Air-Conditioning and Ventilating Systems	4. Enhanced Active Fire Protection	12
National Fire Protection Association, NFPA 101 – Life Safety Code	4. Enhanced Active Fire Protection 5. Improved Building Evacuation 7. Improved Procedures and Practices	12, 13, 14, 15, 16, 17, 18, 19, 20, 21, 26
National Fire Protection Association, NFPA 251 – Standard Methods of Tests of Fire Endurance of Building Construction and Materials	2. Enhanced Fire Endurance of Structures 3. New Methods for Fire Resistant Design of Structures	5, 11
National Fire Protection Association, NFPA 297 – Guide on Principles and Practices for Communications Systems	6. Improved Emergency Response	22
National Fire Protection Association, NFPA 1221 – Standard for the Installation, Maintenance, and Use of Emergency Service Communications Systems	6. Improved Emergency Response	21, 22, 23, 24

Affected Standard	Group Number	Recommendation
National Fire Protection Association, NFPA 1500 – Standard on Fire Department Occupational Safety and Health	6. Improved Emergency Response	21, 23, 24
National Fire Protection Association, NFPA 1561 – Standard on Emergency Services Incident Management System	6. Improved Emergency Response	21, 23, 24
National Fire Protection Association, NFPA 1620 – Recommended Practice for Pre-Incident Planning	6. Improved Emergency Response	21, 23, 24
National Fire Protection Association, NFPA 1710 – Standard for the Organization and Deployment of Fire Suppression Operations, Emergency Medical Operations, and Special Operations to the Public by Career Fire Departments	6. Improved Emergency Response	21, 23, 24
Underwriters Laboratories, UL 263 – Fire Tests of Building Construction and Materials	2. Enhanced Fire Endurance of Structures 3. New Methods for Fire Resistant Design of Structures	5, 9, 11

**Table 9–2b. Model Codes Affected by the Recommendations.**

Affected Model Code	Group	Recommendation
International Building Code	1. Increased Structural Integrity 2. Enhanced Fire Endurance of Structures 3. New Methods for Fire Resistant Design of Structures 4. Improved Active Fire Protection 5. Improved Building Evacuation 6. Improved Emergency Response 7. Improved Procedures and Practices 8. Education and Training	1–24, 26–29
International Existing Building Code	7. Improved Procedures and Practices	26
International Fire Code	7. Improved Procedures and Practices	26
National Fire Protection Association, NFPA 5000 – Building Construction and Safety Code	1. Increased Structural Integrity 2. Enhanced Fire Endurance of Structures 3. New Methods for Fire Resistant Design of Structures 4. Improved Active Fire Protection 5. Improved Building Evacuation 6. Improved Emergency Response 7. Improved Procedures and Practices 8. Education and Training	1–24, 26–29

**Table 9–2c. Organizations Affected by the Recommendations.**

<b>Affected Organization</b>	<b>Group</b>	<b>Recommendation</b>
American Concrete Institute	1. Increased Structural Integrity 2. Enhanced Fire Endurance of Structures 3. New Methods for Fire Resistant Design of Structures 8. Education and Training	1, 3, 6, 8, 9, 11, 29, 30
American Institute of Architects	7. Improved Procedures and Practices 8. Education and Training	28, 29, 30
American Institute of Steel Construction	3. New Methods for Fire Resistant Design of Structures 8. Education and Training	1, 3, 8, 9, 29, 30
American National Standards Institute	5. Improved Building Evacuation 6. Improved Emergency Response	16, 20, 21
American Society of Civil Engineers	1. Increased Structural Integrity 3. New Methods for Fire Resistant Design of Structures 7. Improved Procedures and Practices 8. Education and Training	1, 2, 3, 8, 9, 26, 29, 30
American Society of Mechanical Engineers	2. Enhanced Fire Endurance of Structures 5. Improved Building Evacuation 6. Improved Emergency Response 8. Education and Training	5, 17, 20, 21, 29, 30
Association of the Wall and Ceiling Industry	2. Enhanced Fire Endurance of Structures	6
ASTM International	2. Enhanced Fire Endurance of Structures 3. New Methods for Fire Resistant Design of Structures 5. Improved Building Evacuation	6, 9, 10, 11, 20
Building Owners & Managers Association	5. Improved Building Evacuation	16
Council on Tall Buildings and Urban Habitat	5. Improved Building Evacuation	16
Department of Homeland Security	6. Improved Building Evacuation	22, 23, 24
Federal Communications Commission	6. Improved Emergency Response	22, 23, 24
International Code Council	1. Increased Structural Integrity 2. Enhanced Fire Endurance of Structures 5. Improved Building Evacuation 8. Education and Training	1, 4, 16, 30
International Organization for Standardization	2. Enhanced Fire Endurance of Structures 3. New Methods for Fire Resistant Design of Structures	5, 9, 11
National Conference of States on Building Codes & Standards, Inc.	5. Improved Building Evacuation	16

Affected Organization	Group	Recommendation
National Fire Protection Association	<ol style="list-style-type: none"> <li>1. Increased Structural Integrity</li> <li>2. Enhanced Fire Endurance of Structures</li> <li>3. New Methods for Fire Resistant Design of Structures</li> <li>4. Enhance Active Fire Protection</li> <li>5. Improved Building Evacuation</li> <li>6. Improved Emergency Response</li> <li>7. Improved Procedures and Practices</li> <li>8. Education and Training</li> </ol>	1, 4, 5, 8, 9, 11, 12, 13, 14, 15, 16, 17, 18, 19, 20, 21, 22, 23, 24, 26, 30
National Institute of Building Sciences	5. Improved Building Evacuation	16
Society of Fire Protection Engineers	<ol style="list-style-type: none"> <li>3. New Methods for Fire Resistant Design of Structures</li> <li>8. Education and Training</li> </ol>	8, 9, 29, 30
State licensing boards	8. Education and Training	29
Underwriters Laboratories	<ol style="list-style-type: none"> <li>2. Enhanced Fire Endurance of Structures</li> <li>3. New Methods for Fire Resistant Design of Structures</li> </ol>	5, 11



# Appendix A

## NATIONAL CONSTRUCTION SAFETY TEAM ACT

---

PUBLIC LAW 107-231—OCT. 1, 2002

116 STAT. 1471

Public Law 107-231  
107th Congress

### An Act

To provide for the establishment of investigative teams to assess building performance and emergency response and evacuation procedures in the wake of any building failure that has resulted in substantial loss of life or that posed significant potential of substantial loss of life.

Oct. 1, 2002  
[H.R. 4687]

*Be it enacted by the Senate and House of Representatives of the United States of America in Congress assembled,*

#### SECTION 1. SHORT TITLE.

This Act may be cited as the “National Construction Safety Team Act”.

National  
Construction  
Safety Team Act.  
15 USC 7301  
note.

#### SEC. 2. NATIONAL CONSTRUCTION SAFETY TEAMS.

15 USC 7301.

(a) **ESTABLISHMENT.**—The Director of the National Institute of Standards and Technology (in this Act referred to as the “Director”) is authorized to establish National Construction Safety Teams (in this Act referred to as a “Team”) for deployment after events causing the failure of a building or buildings that has resulted in substantial loss of life or that posed significant potential for substantial loss of life. To the maximum extent practicable, the Director shall establish and deploy a Team within 48 hours after such an event. The Director shall promptly publish in the Federal Register notice of the establishment of each Team.

Federal Register,  
publication.

#### (b) PURPOSE OF INVESTIGATION; DUTIES.—

(1) **PURPOSE.**—The purpose of investigations by Teams is to improve the safety and structural integrity of buildings in the United States.

#### (2) **DUTIES.**—A Team shall—

(A) establish the likely technical cause or causes of the building failure;

(B) evaluate the technical aspects of evacuation and emergency response procedures;

(C) recommend, as necessary, specific improvements to building standards, codes, and practices based on the findings made pursuant to subparagraphs (A) and (B); and

(D) recommend any research and other appropriate actions needed to improve the structural safety of buildings, and improve evacuation and emergency response procedures, based on the findings of the investigation.

#### (c) **PROCEDURES.**—

(1) **DEVELOPMENT.**—Not later than 3 months after the date of the enactment of this Act, the Director, in consultation with the United States Fire Administration and other appropriate Federal agencies, shall develop procedures for the establishment and deployment of Teams. The Director shall

Deadline.

116 STAT. 1472

PUBLIC LAW 107-231—OCT. 1, 2002

update such procedures as appropriate. Such procedures shall include provisions—

(A) regarding conflicts of interest related to service on the Team;

(B) defining the circumstances under which the Director will establish and deploy a Team;

(C) prescribing the appropriate size of Teams;

(D) guiding the disclosure of information under section 8;

(E) guiding the conduct of investigations under this Act, including procedures for providing written notice of inspection authority under section 4(a) and for ensuring compliance with any other applicable law;

(F) identifying and prescribing appropriate conditions for the provision by the Director of additional resources and services Teams may need;

(G) to ensure that investigations under this Act do not impede and are coordinated with any search and rescue efforts being undertaken at the site of the building failure;

(H) for regular briefings of the public on the status of the investigative proceedings and findings;

(I) guiding the Teams in moving and preserving evidence as described in section 4 (a)(4), (b)(2), and (d)(4);

(J) providing for coordination with Federal, State, and local entities that may sponsor research or investigations of building failures, including research conducted under the Earthquake Hazards Reduction Act of 1977; and

(K) regarding such other issues as the Director considers appropriate.

Federal Register,  
publication.

(2) PUBLICATION.—The Director shall publish promptly in the Federal Register final procedures, and subsequent updates thereof, developed under paragraph (1).

15 USC 7302.

### SEC. 3. COMPOSITION OF TEAMS.

Each Team shall be composed of individuals selected by the Director and led by an individual designated by the Director. Team members shall include at least 1 employee of the National Institute of Standards and Technology and shall include other experts who are not employees of the National Institute of Standards and Technology, who may include private sector experts, university experts, representatives of professional organizations with appropriate expertise, and appropriate Federal, State, or local officials. Team members who are not Federal employees shall be considered Federal Government contractors.

15 USC 7303.

### SEC. 4. AUTHORITIES.

(a) ENTRY AND INSPECTION.—In investigating a building failure under this Act, members of a Team, and any other person authorized by the Director to support a Team, on display of appropriate credentials provided by the Director and written notice of inspection authority, may—

(1) enter property where a building failure being investigated has occurred, or where building components, materials, and artifacts with respect to the building failure are located, and take action necessary, appropriate, and reasonable in light of the nature of the property to be inspected to carry out the duties of the Team under section 2(b)(2) (A) and (B);

PUBLIC LAW 107-231—OCT. 1, 2002

116 STAT. 1473

(2) during reasonable hours, inspect any record (including any design, construction, or maintenance record), process, or facility related to the investigation;

(3) inspect and test any building components, materials, and artifacts related to the building failure; and

(4) move such records, components, materials, and artifacts as provided by the procedures developed under section 2(c)(1).

(b) AVOIDING UNNECESSARY INTERFERENCE AND PRESERVING EVIDENCE.—An inspection, test, or other action taken by a Team under this section shall be conducted in a way that—

(1) does not interfere unnecessarily with services provided by the owner or operator of the building components, materials, or artifacts, property, records, process, or facility; and

(2) to the maximum extent feasible, preserves evidence related to the building failure, consistent with the ongoing needs of the investigation.

(c) COORDINATION.—

(1) WITH SEARCH AND RESCUE EFFORTS.—A Team shall not impede, and shall coordinate its investigation with, any search and rescue efforts being undertaken at the site of the building failure.

(2) WITH OTHER RESEARCH.—A Team shall coordinate its investigation, to the extent practicable, with qualified researchers who are conducting engineering or scientific (including social science) research relating to the building failure.

(3) MEMORANDA OF UNDERSTANDING.—The National Institute of Standards and Technology shall enter into a memorandum of understanding with each Federal agency that may conduct or sponsor a related investigation, providing for coordination of investigations.

(4) WITH STATE AND LOCAL AUTHORITIES.—A Team shall cooperate with State and local authorities carrying out any activities related to a Team's investigation.

(d) INTERAGENCY PRIORITIES.—

(1) IN GENERAL.—Except as provided in paragraph (2) or (3), a Team investigation shall have priority over any other investigation of any other Federal agency.

(2) NATIONAL TRANSPORTATION SAFETY BOARD.—If the National Transportation Safety Board is conducting an investigation related to an investigation of a Team, the National Transportation Safety Board investigation shall have priority over the Team investigation. Such priority shall not otherwise affect the authority of the Team to continue its investigation under this Act.

(3) CRIMINAL ACTS.—If the Attorney General, in consultation with the Director, determines, and notifies the Director, that circumstances reasonably indicate that the building failure being investigated by a Team may have been caused by a criminal act, the Team shall relinquish investigative priority to the appropriate law enforcement agency. The relinquishment of investigative priority by the Team shall not otherwise affect the authority of the Team to continue its investigation under this Act.

(4) PRESERVATION OF EVIDENCE.—If a Federal law enforcement agency suspects and notifies the Director that a building failure being investigated by a Team under this Act may have

116 STAT. 1474

PUBLIC LAW 107-231—OCT. 1, 2002

been caused by a criminal act, the Team, in consultation with the Federal law enforcement agency, shall take necessary actions to ensure that evidence of the criminal act is preserved.

15 USC 7304.

**SEC. 5. BRIEFINGS, HEARINGS, WITNESSES, AND SUBPOENAS.**

(a) **GENERAL AUTHORITY.**—The Director or his designee, on behalf of a Team, may conduct hearings, administer oaths, and require, by subpoena (pursuant to subsection (e)) and otherwise, necessary witnesses and evidence as necessary to carry out this Act.

(b) **BRIEFINGS.**—The Director or his designee (who may be the leader or a member of a Team), on behalf of a Team, shall hold regular public briefings on the status of investigative proceedings and findings, including a final briefing after the report required by section 8 is issued.

(c) **PUBLIC HEARINGS.**—During the course of an investigation by a Team, the National Institute of Standards and Technology may, if the Director considers it to be in the public interest, hold a public hearing for the purposes of—

(1) gathering testimony from witnesses; and

(2) informing the public on the progress of the investigation.

(d) **PRODUCTION OF WITNESSES.**—A witness or evidence in an investigation under this Act may be summoned or required to be produced from any place in the United States. A witness summoned under this subsection is entitled to the same fee and mileage the witness would have been paid in a court of the United States.

(e) **ISSUANCE OF SUBPOENAS.**—A subpoena shall be issued only under the signature of the Director but may be served by any person designated by the Director.

(f) **FAILURE TO OBEY SUBPOENA.**—If a person disobeys a subpoena issued by the Director under this Act, the Attorney General, acting on behalf of the Director, may bring a civil action in a district court of the United States to enforce the subpoena. An action under this subsection may be brought in the judicial district in which the person against whom the action is brought resides, is found, or does business. The court may punish a failure to obey an order of the court to comply with the subpoena as a contempt of court.

15 USC 7305.

**SEC. 6. ADDITIONAL POWERS.**

In order to support Teams in carrying out this Act, the Director may—

(1) procure the temporary or intermittent services of experts or consultants under section 3109 of title 5, United States Code;

(2) request the use, when appropriate, of available services, equipment, personnel, and facilities of a department, agency, or instrumentality of the United States Government on a reimbursable or other basis;

(3) confer with employees and request the use of services, records, and facilities of State and local governmental authorities;

(4) accept voluntary and uncompensated services;

(5) accept and use gifts of money and other property, to the extent provided in advance in appropriations Acts;

(6) make contracts with nonprofit entities to carry out studies related to purpose, functions, and authorities of the Teams; and

PUBLIC LAW 107-231—OCT. 1, 2002

116 STAT. 1475

(7) provide nongovernmental members of the Team reasonable compensation for time spent carrying out activities under this Act.

**SEC. 7. DISCLOSURE OF INFORMATION.**

15 USC 7306.

(a) **GENERAL RULE.**—Except as otherwise provided in this section, a copy of a record, information, or investigation submitted or received by a Team shall be made available to the public on request and at reasonable cost.

Records.

(b) **EXCEPTIONS.**—Subsection (a) does not require the release of—

(1) information described by section 552(b) of title 5, United States Code, or protected from disclosure by any other law of the United States; or

(2) information described in subsection (a) by the National Institute of Standards and Technology or by a Team until the report required by section 8 is issued.

(c) **PROTECTION OF VOLUNTARY SUBMISSION OF INFORMATION.**—Notwithstanding any other provision of law, a Team, the National Institute of Standards and Technology, and any agency receiving information from a Team or the National Institute of Standards and Technology, shall not disclose voluntarily provided safety-related information if that information is not directly related to the building failure being investigated and the Director finds that the disclosure of the information would inhibit the voluntary provision of that type of information.

(d) **PUBLIC SAFETY INFORMATION.**—A Team and the National Institute of Standards and Technology shall not publicly release any information it receives in the course of an investigation under this Act if the Director finds that the disclosure of that information might jeopardize public safety.

**SEC. 8. NATIONAL CONSTRUCTION SAFETY TEAM REPORT.**

15 USC 7307.

Not later than 90 days after completing an investigation, a Team shall issue a public report which includes—

Deadline.

(1) an analysis of the likely technical cause or causes of the building failure investigated;

(2) any technical recommendations for changes to or the establishment of evacuation and emergency response procedures;

(3) any recommended specific improvements to building standards, codes, and practices; and

(4) recommendations for research and other appropriate actions needed to help prevent future building failures.

**SEC. 9. NATIONAL INSTITUTE OF STANDARDS AND TECHNOLOGY ACTIONS.**

15 USC 7308.

After the issuance of a public report under section 8, the National Institute of Standards and Technology shall comprehensively review the report and, working with the United States Fire Administration and other appropriate Federal and non-Federal agencies and organizations—

(1) conduct, or enable or encourage the conducting of, appropriate research recommended by the Team; and

(2) promote (consistent with existing procedures for the establishment of building standards, codes, and practices) the

116 STAT. 1476

PUBLIC LAW 107-231—OCT. 1, 2002

appropriate adoption by the Federal Government, and encourage the appropriate adoption by other agencies and organizations, of the recommendations of the Team with respect to—

(A) technical aspects of evacuation and emergency response procedures;

(B) specific improvements to building standards, codes, and practices; and

(C) other actions needed to help prevent future building failures.

15 USC 7309.

**SEC. 10. NATIONAL INSTITUTE OF STANDARDS AND TECHNOLOGY ANNUAL REPORT.**

Deadline.

Not later than February 15 of each year, the Director shall transmit to the Committee on Science of the House of Representatives and to the Committee on Commerce, Science, and Transportation of the Senate a report that includes—

(1) a summary of the investigations conducted by Teams during the prior fiscal year;

(2) a summary of recommendations made by the Teams in reports issued under section 8 during the prior fiscal year and a description of the extent to which those recommendations have been implemented; and

(3) a description of the actions taken to improve building safety and structural integrity by the National Institute of Standards and Technology during the prior fiscal year in response to reports issued under section 8.

15 USC 7310.

**SEC. 11. ADVISORY COMMITTEE.**

(a) **ESTABLISHMENT AND FUNCTIONS.**—The Director, in consultation with the United States Fire Administration and other appropriate Federal agencies, shall establish an advisory committee to advise the Director on carrying out this Act and to review the procedures developed under section 2(c)(1) and the reports issued under section 8.

Deadline.

(b) **ANNUAL REPORT.**—On January 1 of each year, the advisory committee shall transmit to the Committee on Science of the House of Representatives and to the Committee on Commerce, Science, and Transportation of the Senate a report that includes—

(1) an evaluation of Team activities, along with recommendations to improve the operation and effectiveness of Teams; and

(2) an assessment of the implementation of the recommendations of Teams and of the advisory committee.

(c) **DURATION OF ADVISORY COMMITTEE.**—Section 14 of the Federal Advisory Committee Act shall not apply to the advisory committee established under this section.

15 USC 7311.

**SEC. 12. ADDITIONAL APPLICABILITY.**

The authorities and restrictions applicable under this Act to the Director and to Teams shall apply to the activities of the National Institute of Standards and Technology in response to the attacks of September 11, 2001.

**SEC. 13. AMENDMENT.**

Section 7 of the National Bureau of Standards Authorization Act for Fiscal Year 1986 (15 U.S.C. 281a) is amended by inserting “, or from an investigation under the National Construction Safety Team Act,” after “from such investigation”.

PUBLIC LAW 107-231—OCT. 1, 2002

116 STAT. 1477

**SEC. 14. CONSTRUCTION.**

15 USC 7312.

Nothing in this Act shall be construed to confer any authority on the National Institute of Standards and Technology to require the adoption of building standards, codes, or practices.

**SEC. 15. AUTHORIZATION OF APPROPRIATIONS.**

15 USC 7313.

The National Institute of Standards and Technology is authorized to use funds otherwise authorized by law to carry out this Act.

Approved October 1, 2002.

---

**LEGISLATIVE HISTORY—H.R. 4687:**

HOUSE REPORTS: No. 107-530 (Comm. on Science).

CONGRESSIONAL RECORD, Vol. 148 (2002):

July 12, considered and passed House.

Sept. 9, considered and passed Senate, amended.

Sept. 17, House concurred in Senate amendment.

○

This page intentionally left blank.



## Appendix B

# WORLD TRADE CENTER INVESTIGATION PUBLICATIONS

---

This report, NIST NCSTAR 1, covers the WTC towers, with a separate report on the 47-story WTC 7. Supporting documentation of the techniques and technologies used in the investigation are in a set of companion reports that provide more details of the Investigation findings and the means by which these technical results were achieved. The titles of the full set of Investigation publications are:

NIST (National Institute of Standards and Technology). 2005. *Federal Building and Fire Safety Investigation of the World Trade Center Disaster: Final Report on the Collapse of the World Trade Center Towers*. NIST NCSTAR 1. Gaithersburg, MD, September.

NIST (National Institute of Standards and Technology). 2008. *Federal Building and Fire Safety Investigation of the World Trade Center Disaster: Final Report on the Collapse of World Trade Center 7*. NIST NCSTAR 1A. Gaithersburg, MD, November.

Lew, H. S., R. W. Bukowski, and N. J. Carino. 2005. *Federal Building and Fire Safety Investigation of the World Trade Center Disaster: Design, Construction, and Maintenance of Structural and Life Safety Systems*. NIST NCSTAR 1-1. National Institute of Standards and Technology. Gaithersburg, MD, September.

Fanella, D. A., A. T. Derecho, and S. K. Ghosh. 2005. *Federal Building and Fire Safety Investigation of the World Trade Center Disaster: Design and Construction of Structural Systems*. NIST NCSTAR 1-1A. National Institute of Standards and Technology. Gaithersburg, MD, September.

Ghosh, S. K., and X. Liang. 2005. *Federal Building and Fire Safety Investigation of the World Trade Center Disaster: Comparison of Building Code Structural Requirements*. NIST NCSTAR 1-1B. National Institute of Standards and Technology. Gaithersburg, MD, September.

Fanella, D. A., A. T. Derecho, and S. K. Ghosh. 2005. *Federal Building and Fire Safety Investigation of the World Trade Center Disaster: Maintenance and Modifications to Structural Systems*. NIST NCSTAR 1-1C. National Institute of Standards and Technology. Gaithersburg, MD, September.

Grill, R. A., and D. A. Johnson. 2005. *Federal Building and Fire Safety Investigation of the World Trade Center Disaster: Fire Protection and Life Safety Provisions Applied to the Design and Construction of World Trade Center 1, 2, and 7 and Post-Construction Provisions Applied after Occupancy*. NIST NCSTAR 1-1D. National Institute of Standards and Technology. Gaithersburg, MD, September.

Razza, J. C., and R. A. Grill. 2005. *Federal Building and Fire Safety Investigation of the World Trade Center Disaster: Comparison of Codes, Standards, and Practices in Use at the Time of the Design and Construction of World Trade Center 1, 2, and 7*. NIST NCSTAR 1-1E. National Institute of Standards and Technology. Gaithersburg, MD, September.

Grill, R. A., D. A. Johnson, and D. A. Fanella. 2005. *Federal Building and Fire Safety Investigation of the World Trade Center Disaster: Comparison of the 1968 and Current (2003) New York City Building Code Provisions*. NIST NCSTAR 1-1F. National Institute of Standards and Technology. Gaithersburg, MD, September.

Grill, R. A., and D. A. Johnson. 2005. *Federal Building and Fire Safety Investigation of the World Trade Center Disaster: Amendments to the Fire Protection and Life Safety Provisions of the New York City Building Code by Local Laws Adopted While World Trade Center 1, 2, and 7 Were in Use*. NIST NCSTAR 1-1G. National Institute of Standards and Technology. Gaithersburg, MD, September.

Grill, R. A., and D. A. Johnson. 2005. *Federal Building and Fire Safety Investigation of the World Trade Center Disaster: Post-Construction Modifications to Fire Protection and Life Safety Systems of World Trade Center 1 and 2*. NIST NCSTAR 1-1H. National Institute of Standards and Technology. Gaithersburg, MD, September.

Grill, R. A., D. A. Johnson, and D. A. Fanella. 2005. *Federal Building and Fire Safety Investigation of the World Trade Center Disaster: Post-Construction Modifications to Fire Protection, Life Safety, and Structural Systems of World Trade Center 7*. NIST NCSTAR 1-1I. National Institute of Standards and Technology. Gaithersburg, MD, September.

Grill, R. A., and D. A. Johnson. 2005. *Federal Building and Fire Safety Investigation of the World Trade Center Disaster: Design, Installation, and Operation of Fuel System for Emergency Power in World Trade Center 7*. NIST NCSTAR 1-1J. National Institute of Standards and Technology. Gaithersburg, MD, September.

Sadek, F. 2005. *Federal Building and Fire Safety Investigation of the World Trade Center Disaster: Baseline Structural Performance and Aircraft Impact Damage Analysis of the World Trade Center Towers*. NIST NCSTAR 1-2. National Institute of Standards and Technology. Gaithersburg, MD, September.

Faschan, W. J., and R. B. Garlock. 2005. *Federal Building and Fire Safety Investigation of the World Trade Center Disaster: Reference Structural Models and Baseline Performance Analysis of the World Trade Center Towers*. NIST NCSTAR 1-2A. National Institute of Standards and Technology. Gaithersburg, MD, September.

Kirkpatrick, S. W., R. T. Bocchieri, F. Sadek, R. A. MacNeill, S. Holmes, B. D. Peterson, R. W. Cilke, C. Navarro. 2005. *Federal Building and Fire Safety Investigation of the World Trade Center Disaster: Analysis of Aircraft Impacts into the World Trade Center Towers*, NIST NCSTAR 1-2B. National Institute of Standards and Technology. Gaithersburg, MD, September.

Gayle, F. W., R. J. Fields, W. E. Luecke, S. W. Banovic, T. Foecke, C. N. McCowan, T. A. Siewert, and J. D. McColskey. 2005. *Federal Building and Fire Safety Investigation of the World Trade Center Disaster: Mechanical and Metallurgical Analysis of Structural Steel*. NIST NCSTAR 1-3. National Institute of Standards and Technology. Gaithersburg, MD, September.

- Luecke, W. E., T. A. Siewert, and F. W. Gayle. 2005. *Federal Building and Fire Safety Investigation of the World Trade Center Disaster: Contemporaneous Structural Steel Specifications*. NIST Special Publication 1-3A. National Institute of Standards and Technology. Gaithersburg, MD, September.
- Banovic, S. W. 2005. *Federal Building and Fire Safety Investigation of the World Trade Center Disaster: Steel Inventory and Identification*. NIST NCSTAR 1-3B. National Institute of Standards and Technology. Gaithersburg, MD, September.
- Banovic, S. W., and T. Foecke. 2005. *Federal Building and Fire Safety Investigation of the World Trade Center Disaster: Damage and Failure Modes of Structural Steel Components*. NIST NCSTAR 1-3C. National Institute of Standards and Technology. Gaithersburg, MD, September.
- Luecke, W. E., J. D. McColskey, C. N. McCowan, S. W. Banovic, R. J. Fields, T. Foecke, T. A. Siewert, and F. W. Gayle. 2005. *Federal Building and Fire Safety Investigation of the World Trade Center Disaster: Mechanical Properties of Structural Steels*. NIST NCSTAR 1-3D. National Institute of Standards and Technology. Gaithersburg, MD, September.
- Banovic, S. W., C. N. McCowan, and W. E. Luecke. 2005. *Federal Building and Fire Safety Investigation of the World Trade Center Disaster: Physical Properties of Structural Steels*. NIST NCSTAR 1-3E. National Institute of Standards and Technology. Gaithersburg, MD, September.
- Evans, D. D., R. D. Peacock, E. D. Kuligowski, W. S. Dols, and W. L. Grosshandler. 2005. *Federal Building and Fire Safety Investigation of the World Trade Center Disaster: Active Fire Protection Systems*. NIST NCSTAR 1-4. National Institute of Standards and Technology. Gaithersburg, MD, September.
- Kuligowski, E. D., D. D. Evans, and R. D. Peacock. 2005. *Federal Building and Fire Safety Investigation of the World Trade Center Disaster: Post-Construction Fires Prior to September 11, 2001*. NIST NCSTAR 1-4A. National Institute of Standards and Technology. Gaithersburg, MD, September.
- Hopkins, M., J. Schoenrock, and E. Budnick. 2005. *Federal Building and Fire Safety Investigation of the World Trade Center Disaster: Fire Suppression Systems*. NIST NCSTAR 1-4B. National Institute of Standards and Technology. Gaithersburg, MD, September.
- Keough, R. J., and R. A. Grill. 2005. *Federal Building and Fire Safety Investigation of the World Trade Center Disaster: Fire Alarm Systems*. NIST NCSTAR 1-4C. National Institute of Standards and Technology. Gaithersburg, MD, September.
- Ferreira, M. J., and S. M. Strege. 2005. *Federal Building and Fire Safety Investigation of the World Trade Center Disaster: Smoke Management Systems*. NIST NCSTAR 1-4D. National Institute of Standards and Technology. Gaithersburg, MD, September.
- Gann, R. G., A. Hamins, K. B. McGrattan, G. W. Mulholland, H. E. Nelson, T. J. Ohlemiller, W. M. Pitts, and K. R. Prasad. 2005. *Federal Building and Fire Safety Investigation of the World Trade Center Disaster: Reconstruction of the Fires in the World Trade Center Towers*. NIST NCSTAR 1-5. National Institute of Standards and Technology. Gaithersburg, MD, September.

Pitts, W. M., K. M. Butler, and V. Junker. 2005. *Federal Building and Fire Safety Investigation of the World Trade Center Disaster: Visual Evidence, Damage Estimates, and Timeline Analysis*. NIST NCSTAR 1-5A. National Institute of Standards and Technology. Gaithersburg, MD, September.

Hamins, A., A. Maranghides, K. B. McGrattan, E. Johnsson, T. J. Ohlemiller, M. Donnelly, J. Yang, G. Mulholland, K. R. Prasad, S. Kukuck, R. Anleitner and T. McAllister. 2005. *Federal Building and Fire Safety Investigation of the World Trade Center Disaster: Experiments and Modeling of Structural Steel Elements Exposed to Fire*. NIST NCSTAR 1-5B. National Institute of Standards and Technology. Gaithersburg, MD, September.

Ohlemiller, T. J., G. W. Mulholland, A. Maranghides, J. J. Filliben, and R. G. Gann. 2005. *Federal Building and Fire Safety Investigation of the World Trade Center Disaster: Fire Tests of Single Office Workstations*. NIST NCSTAR 1-5C. National Institute of Standards and Technology. Gaithersburg, MD, September.

Gann, R. G., M. A. Riley, J. M. Repp, A. S. Whittaker, A. M. Reinhorn, and P. A. Hough. 2005. *Federal Building and Fire Safety Investigation of the World Trade Center Disaster: Reaction of Ceiling Tile Systems to Shocks*. NIST NCSTAR 1-5D. National Institute of Standards and Technology. Gaithersburg, MD, September.

Hamins, A., A. Maranghides, K. B. McGrattan, T. J. Ohlemiller, and R. Anleitner. 2005. *Federal Building and Fire Safety Investigation of the World Trade Center Disaster: Experiments and Modeling of Multiple Workstations Burning in a Compartment*. NIST NCSTAR 1-5E. National Institute of Standards and Technology. Gaithersburg, MD, September.

McGrattan, K. B., C. Bouldin, and G. Forney. 2005. *Federal Building and Fire Safety Investigation of the World Trade Center Disaster: Computer Simulation of the Fires in the World Trade Center Towers*. NIST NCSTAR 1-5F. National Institute of Standards and Technology. Gaithersburg, MD, September.

Prasad, K. R., and H. R. Baum. 2005. *Federal Building and Fire Safety Investigation of the World Trade Center Disaster: Fire Structure Interface and Thermal Response of the World Trade Center Towers*. NIST NCSTAR 1-5G. National Institute of Standards and Technology. Gaithersburg, MD, September.

Gross, J. L., and T. McAllister. 2005. *Federal Building and Fire Safety Investigation of the World Trade Center Disaster: Structural Fire Response and Probable Collapse Sequence of the World Trade Center Towers*. NIST NCSTAR 1-6. National Institute of Standards and Technology. Gaithersburg, MD, September.

Carino, N. J., M. A. Starnes, J. L. Gross, J. C. Yang, S. Kukuck, K. R. Prasad, and R. W. Bukowski. 2005. *Federal Building and Fire Safety Investigation of the World Trade Center Disaster: Passive Fire Protection*. NIST NCSTAR 1-6A. National Institute of Standards and Technology. Gaithersburg, MD, September.

- Gross, J., F. Hervey, M. Izydorek, J. Mammoser, and J. Treadway. 2005. *Federal Building and Fire Safety Investigation of the World Trade Center Disaster: Fire Resistance Tests of Floor Truss Systems*. NIST NCSTAR 1-6B. National Institute of Standards and Technology. Gaithersburg, MD, September.
- Zarghamee, M. S., S. Bolourchi, D. W. Eggers, Ö. O. Erbay, F. W. Kan, Y. Kitane, A. A. Liepins, M. Mudlock, W. I. Naguib, R. P. Ojdovic, A. T. Sarawit, P. R. Barrett, J. L. Gross, and T. P. McAllister. 2005. *Federal Building and Fire Safety Investigation of the World Trade Center Disaster: Component, Connection, and Subsystem Structural Analysis*. NIST NCSTAR 1-6C. National Institute of Standards and Technology. Gaithersburg, MD, September.
- Zarghamee, M. S., Y. Kitane, Ö. O. Erbay, T. P. McAllister, and J. L. Gross. 2005. *Federal Building and Fire Safety Investigation of the World Trade Center Disaster: Global Structural Analysis of the Response of the World Trade Center Towers to Impact Damage and Fire*. NIST NCSTAR 1-6D. National Institute of Standards and Technology. Gaithersburg, MD, September.
- Averill, J. D., D. S. Mileti, R. D. Peacock, E. D. Kuligowski, N. Groner, G. Proulx, P. A. Reneke, and H. E. Nelson. 2005. *Federal Building and Fire Safety Investigation of the World Trade Center Disaster: Occupant Behavior, Egress, and Emergency Communication*. NIST NCSTAR 1-7. National Institute of Standards and Technology. Gaithersburg, MD, September.
- Fahy, R., and G. Proulx. 2005. *Federal Building and Fire Safety Investigation of the World Trade Center Disaster: Analysis of Published Accounts of the World Trade Center Evacuation*. NIST NCSTAR 1-7A. National Institute of Standards and Technology. Gaithersburg, MD, September.
- Zmud, J. 2005. *Federal Building and Fire Safety Investigation of the World Trade Center Disaster: Technical Documentation for Survey Administration*. NIST NCSTAR 1-7B. National Institute of Standards and Technology. Gaithersburg, MD, September.
- Lawson, J. R., and R. L. Vettori. 2005. *Federal Building and Fire Safety Investigation of the World Trade Center Disaster: The Emergency Response Operations*. NIST NCSTAR 1-8. National Institute of Standards and Technology. Gaithersburg, MD, September.
- McAllister, T., R. G. Gann, J. D. Averill, J. L. Gross, W. L. Grosshandler, J. R. Lawson, K. B. McGrattan, H. E. Nelson, W. M. Pitts, K. R. Prasad, F. H. Sadek. 2008. *Federal Building and Fire Safety Investigation of the World Trade Center Disaster: Structural Fire Response and Probable Collapse Sequence of World Trade Center Building 7*. NIST NCSTAR 1-9. National Institute of Standards and Technology. Gaithersburg, MD, November.
- MacNeill, R., S. Kirkpatrick, B. Peterson, and R. Bocchieri. 2008. *Federal Building and Fire Safety Investigation of the World Trade Center Disaster: Global Structural Analysis of the Response of World Trade Center Building 7 to Fires and Debris Impact Damage*. NIST NCSTAR 1-9A. National Institute of Standards and Technology. Gaithersburg, MD, November.

This page intentionally left blank.

# Appendix C

## SUBJECT INDEX OF SUPPORTING INVESTIGATION REPORTS

---

The purpose of this index is to direct readers of NIST NCSTAR 1 to the supporting Investigation reports in which more detailed descriptions of the topics covered in this report can be found. The citations refer to the NIST NCSTAR report numbers; complete citations are in Appendix B to this report. For a subject referenced in a report with a number and a letter (e.g., 1-5A), a summary description of the topic can be found in the report with the number alone (e.g., 1-5). In most of the citations, the pertinent chapter or section numbers in the report appears in parentheses. The absence of these parenthetical locations indicates that much of the report is on that topic.

### Aircraft Impact

Damage .....	1-2 (7, 8), 1-2B, 1-3C (2), 1-5 (2), 1-6 (5)
Modeling .....	1-2 (5), 1-2B
Photographs .....	1-5A (6, 7), 1-2B (7.2), 1-3C (2)
Speed and direction.....	1-2 (6), 1-2B (7), 1-5 (2.2, 2.3)
Results and findings.....	1-2 (7, 8.2), 1-2B (11)

### Building and Fire Codes

Egress.....	1-1 (10), 1-1D (5), 1-7 (2.5)
Fire.....	1-1 (9), 1-1D, 1-1E, 1-1F, 1-1G, 1-1H
Post-construction modifications.....	1-1I (11, 12, 13)
Port Authority policies.....	1-1A (4)
Structural.....	1-1 (4), 1-1A (2), 1-1B, 1-1C, 1-6 (10.2)
Used in WTC design.....	1-1 (1 to 7)

### Collapse

Observations and timeline.....	1-6 (6), 1-3C (2)
Probable sequences .....	1-6 (9, 10.9), 1-6D (5)

### Combustibles

Aircraft contents .....	1-5 (3.3)
Jet fuel distribution and locations .....	1-2, 1-8 (5.3)
Jet fuel quantity.....	1-5 (3.3)
Workstations .....	1-5 (3.2), 1-5C, 1-5D

### Concrete

Properties .....	1-6 (4.1), 1-6C (3.1)
------------------	-----------------------

### Elevators (See Evacuation)

### Emergency Response

Chronology .....	1-8 (4)
Communications and equipment.....	1-8 (5.7, 7, 9.2, 9.3)
Data and interviews.....	1-8 (2)
Firefighting .....	1-8 (5.6, 9.1)
Interagency coordination .....	1-8 (8)
Operations .....	1-8 (5, 9.1, 9.4)

Planning .....	1-8 (6)
<b>Evacuation</b>	
Data and interviews.....	1-7 (3), 1-7A, 1-7B
Egress system design .....	1-1 (10), 1-1E (2.8), 1-1H (3, 4, 5)
Elevators .....	1-1 (10.4), 1-1D (8), 1-1E (2.12), 1-7 (2.2)
Factors affecting .....	1-7 (10)
Firefighter interactions.....	1-8 (5.6)
Mobility-impaired people .....	1-7 (10.3, 11.5)
Modeling.....	1-7 (10)
Progression on 9/11/01 .....	1-7 (5, 6, 7, 8, 9, 11)
Stairwells .....	1-7 (2.2)
<b>Fire Alarm System</b>	
Codes and standards.....	1-1D (7), 1-1E (2.11), 1-1F (2.6), 1-1H (3, 4, 5)
Design .....	1-1 (10), 1-4 (4, 6), 1-4C
Operation on 9/11/01 .....	1-4 (4.5), 1-4C (6), 1-7 (6, 8, 10), 1-8 (5.3)
<b>Fire Behavior</b>	
Characterization .....	1-5A (5)
WTC 1.....	1-5A (8)
WTC 2.....	1-5A (9)
<b>Firefighting</b> (See Emergency Response)	
<b>Fire Simulations</b>	
Accuracy .....	1-5 (4, 5)
Fire Dynamics Simulator (FDS) .....	1-5 (4), 1-5B (10), 1-5C (4), 1-5F
Fire in an undamaged WTC tower.....	1-5 (6.15)
Fire Structure Interface (FSI).....	1-5 (6), 1-5C (11), 1-5G
Results and findings.....	1-5 (6, 7), 1-5F (7), 1-5G (12)
<b>Fire Suppression Systems</b>	
Codes and standards.....	1-1 (10), 1-1D (6), 1-1E (2.9, 2.10), 1-1F (2.5), 1-1H (3, 4, 5), 1-4B (4)
Design .....	1-4 (3, 6), 1-4B
Operation on 9/11/01 .....	1-4 (3), 1-4B (9), 1-8 (5.3)
<b>Fire Tests</b>	
Exposure of structural steel.....	1-5 (5), 1-5B
Floor systems .....	1-6 (3, 10.3), 1-6B
Single office workstations.....	1-5 (4), 1-5C
Multiple workstations .....	1-5 (4), 1-5E
<b>Insulation</b> (for Fire Protection of Structural Steel)	
Damage .....	1-2, 1-3C (2), 1-5G (5), 1-6 (2.7), 1-6A
Modeling.....	1-5G (4, 5, 7), 1-6 (2)
Properties .....	1-6 (2), 1-6A (3, 6, 7)
Specifications .....	1-1H (6, 7, 9), 1-6 (2, 10.1), 1-6A
Thickness .....	1-6A (4, 5)



**Jet Fuel** (See Combustibles)**Photographs and videos**

- Collection..... 1-5 (2), 1-5A (2)
- Timing..... 1-5 (2), 1-5A (3)

**Smoke Management System**

- Design ..... 1-1 (10), 1-1E (2.5, 2.13), 1-1F (2.8), 1-4 (5, 6),  
1-4D
- Operation on 9/11/01 ..... 1-4 (5.4), 1-4D (7, 8), 1-8 (5.3)

**Stairwells** (See Evacuation)**Structural Steel**

- Damage ..... 1-3 (6, 9), 1-3C
- Mechanical properties..... 1-3 (7, 9), 1-3D, 1-6 (4), 1-6C (3)
- Recovered pieces ..... 1-3 (5), 1-3B
- Specifications..... 1-3 (3, 4), 1-3A
- Physical properties ..... 1-3 (8), 1-3E

**Structure Modeling**

- For aircraft impact..... 1-2, 1-2B (2, 3)
- Reference models..... 1-2 (2), 1-2A
- Towers ..... 1-2, 1-5F, 1-6 (4, 7, 8, 10), 1-6C, 1-6D
- Results and findings..... 1-6 (10.8)

**Timelines**

- Aircraft impact..... 1-2, 1-2B, 1-5A
- Evacuation ..... 1-7, 1-8
- Fires ..... 1-5 (2), 1-5A
- Structural..... 1-6 (8, 9)

**World Trade Center Towers**

- Baseline structural performance ..... 1-2 (4, 8), 1-2A (2, 3, 5, 6)
- Ceiling tile system ..... 1-5 (3.1), 1-5D, 1-7 (6.1, 7)
- Description..... 1-1 (2), 1-2A (1), 1-5A (4), 1-7 (2.1)
- Design and construction..... 1-1 (5, 7), 1-1A (6, 7, 8), 1-3 (2), 1-5A (4)
- Fire safety staff ..... 1-7 (2.3)
- Gravity loads..... 1-1B (4), 1-2A (4)
- Innovative features..... 1-1 (6), 1-1A (3, 5)
- Interior layout ..... 1-1 (10), 1-5 (3.1)
- Structural maintenance and modifications..... 1-1 (8), 1-1C
- Modifications post-1993 bombing ..... 1-7 (2.4), 1-8 (3)
- Occupant demographics..... 1-7 (4, 11.1)
- Prior fires ..... 1-4 (2), 1-4A
- Wind loads ..... 1-1B (4), 1-2 (3), 1-2A (4)

This page intentionally left blank.